

Operating instructions

Standard chemical pump
of plastic material
Type series NE

DIN EN ISO 2858:2010

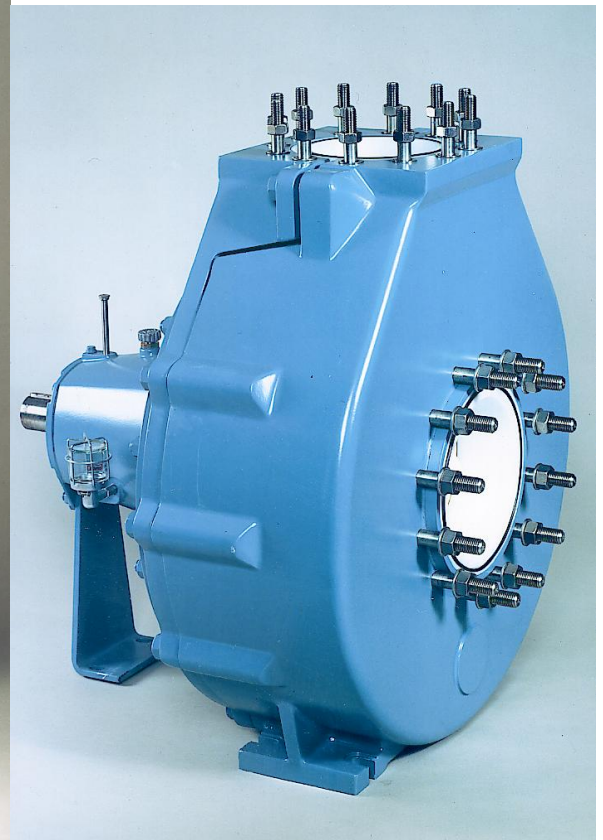

WERNERT-PUMPEN



Identification

Operating instruction NE

Original instructions

Technical changes are reserved.

Identification Number: BA_NE001-2020en

WERNERT-PUMPEN GMBH, Mülheim an der Ruhr, date of issue 03.02.2020,

Rev. 2020-01

o.	Table of contents	
0.	Table of contents	2
	Glossary of terms	6
1.	General	9
1.1	Principles	9
1.2	Target group	9
1.3	Symbols	9
1.4	Intended use of the pump	9
1.5	Validity of the operating instructions	9
1.6	Documentation	9
1.7	Declarations	10
1.7.1	Declaration of conformity for pumps according to directive 2006/42/EC for machines	10
1.8	Technical design	10
1.9	Type description	11
1.10	Type plate	12
1.11	Liability	12
2.	Safety	13
2.1	Marking of warnings	13
2.2	Personnel qualification and training	13
2.3	Dangers in case of non-compliance with the safety hints	14
2.4	Responsible working	14
2.5	Safety hints for the user/operator	14
2.6	Safety instructions for maintenance, inspection and assembly work	15
2.7	Unauthorized conversion and spare parts production	15
2.8	Permissible operating modes	15
2.9	Explosion protection	15
2.9.1	Identifying marking	15
2.9.2	Filling of pump	15
2.9.3	Modes of operation affecting the explosion protection	16
2.9.4	Explosion protection group	16
2.9.5	Equipment category	17
2.9.6	Temperature class	17
2.9.7	Temperature limits (due to explosion protection)	17
2.9.8	Pumping of inflammable media, conductivity	18
2.9.9	Lubricants, coolants	18
2.9.10	Maintenance	18
2.9.11	Coating thickness	18
2.9.12	Chemical compatibility, thermal resistance, pressure resistance	19
2.9.13	Replacement of devices of a pump unit	19
3.	Transport, intermediate storage, disposal	20
3.1	Transport of pumps and pump units	20
3.2	Storage	21
3.2.1	Intermediate storage under normal ambient conditions	21
3.2.2	Intermediate storage under special ambient conditions	21
3.2.3	Longer-term storage	22
3.3	Return to the manufacturer	22
3.4	Recycling and disposal	22
4.	Description of product and accessories	23

4.1	General description	23
4.2	Application limits	23
4.2.1	Maximum permissible test pressure	23
4.2.2	Maximum permissible operating pressure	23
4.2.3	Permissible temperatures	23
4.2.4	Volume flow of the pumped liquid	24
4.2.5	Maximum admissible gas portion of the pumped liquid	24
4.2.6	Maximum dimensions of sporadic solid matters in the liquid pumped	24
4.2.7	Maximum admissible supply pressure for WERNERT bellows-type mechanical seal	25
4.2.8	Maximum speeds	25
4.2.9	Degree of protection	25
4.2.10	Construction	25
4.3	Constructional design	25
4.3.1	Pump casing	25
4.3.2	Impeller	25
4.3.3	Shaft and bearings	26
4.3.4	Sealing the pump	26
4.4	Sectional drawing with part designation	27
4.5	Designs of mechanical seals	28
4.5.1	Single WERNERT-elastomere-bellows-mechanical seal (MS)	28
4.5.2	Single WERNERT-PTFE-bellows-mechanical seal	30
4.5.3	Back-to-back-mechanical seal as defined by DIN EN 12756	32
4.5.4	Stationary double acting mechanical seal	33
4.5.5	General information about double acting mechanical seal	33
4.6	Special tools	36
4.6.1	Impeller key (part 051)	36
4.6.2	Tensioning tools (part 052)	37
4.6.3	Pulling device for left-hand impeller size IV	37
4.7	Noise emission values	40
4.8	Accessories	41
4.9	Dimensions and weights	41
5.	Erection	42
5.1	General	42
5.2	Installation of the pump mounted on the base plate	42
5.2.1	Alignment of the base plate	42
5.2.2	Connecting the pipes	43
5.2.3	Aligning the drive	43
5.3	Pipes	44
5.3.1	General	44
5.3.2	Notes on laying pipes	44
5.3.3	Suction pipe	45
5.3.4	Self-priming by means of liquid reservoir (priming tank)	46
5.3.5	Supply line	47
5.3.6	Discharge line, throttling bush	47
5.3.7	Check valve	47
5.4	Additional connections	48
5.5	Touching protection for coupling	48
5.6	Final inspection	48
5.7	Electric connection	49
6.	Starting up / Operation / Shutting down	50
6.1	Measures prior to commissioning	50

6.1.1	Cleaning and hydraulic pressure test of pipes	50
6.1.2	Ensure bearing lubrication	50
6.1.3	Checking the direction of rotation	51
6.1.4	Tightening the WERNERT–bellows	51
6.1.5	Safety devices for the protection of people	52
6.2	Starting the pump	52
6.3	Operating the pump	54
6.4	Short shutdown of the pump	54
6.5	Shutting the pump down permanently	55
6.6	Reverse flow through the pump	55
7.	Maintenance/ Service	56
7.1	Safety regulations	56
7.2	Monitoring and maintenance of shaft bearings	56
7.2.1	Grease lubrication	57
7.2.1.1	Lifetime–lubricated bearings	57
7.2.1.2	Grease, relubricable	57
7.2.2	Oil lubrication	58
7.2.3	Inspection, maintenance, intervals and tasks	60
7.3	Supply of mechanical seals	63
7.3.1	Single–acting mechanical seals	63
7.3.2	Double acting mechanical seals – DIN EN 12756	63
7.3.3	Stationary double acting mechanical seals	64
7.4	Disassembly and assembly of the pump	66
7.4.1	Disassembly of the pump	66
7.4.2	Assembly of the pump	73
7.5	Leak test	78
7.6	Spare parts	79
8.	Faults; causes and remedies	81
8.1	Pump does not pump even though motor is in operation	81
8.2	Flow and / or delivery head too low	81
8.3	Motor is overloaded	82
8.4	WERNERT–Elastomere–bellows–mechanical seal leaks immediately after starting up	82
8.5	Mechanical seal leaks after longer period of operation	82
8.6	Single mechanical seal is destroyed spontaneously and is therefore leaking	83
8.7	Massive leaks	84
8.8	Pump is destroyed because it was rotating in wrong direction	84
8.9	Increased bearing temperature	84
8.10	Uneven running (noises, vibrations)	84
8.11	Leakage from the quench seal	85
8.12	Leakage from the double–acting mechanical seal	85
9.	Associated documentation	86
10.	Annex A: Name Plate	87
10.1	Design of the name plate	87
10.1.1	Additional name plate for pumps according to Directive 2014/34/EU/EC	88
10.2	WERNERT mechanical seal code (WGC)	89
10.3	Mechanical seal materials	90
11.	Annex B: Admissible Nozzle Loads, Speeds	91
12.	Annex C: Tightening Torques	92

13. Annex D: Continuous flushing, weight

93

Glossary of terms

API Plan

API 682 is a standard describing sealing systems in pumps for the oil & gas and (petro)chemical industries. In this API the API plans are described. They describe the seal supply systems. If the components of an API plan are not defined as part of the scope of delivery in the order confirmation, these parts such as supply lines, valves, non-return valves, manometers, TS systems etc. are not part of the scope of delivery of WERNERT. Then the mechanical seal is suitable for connection according to the API plan mentioned.

Axial thrust

The axial thrust is the resultant of all axial forces acting on the impeller.

Back-pull-out-unit

Pre-assembled spare part, consisting of bearing housing with connecting piece, seal insert, mechanical seal, impeller, housing seal.

Barrier fluid

Refer to sealing pressure system

Cavitation

Refer to vapour pressure

Centrifugal pump

Also known as a centrifugal pump, pump with one or more rotating impellers that suck liquid coaxially to the pump shaft and eject it radially to it. The pressure build-up of the impeller depends in particular on the speed and diameter of the impeller.

Discharge-side

All installations behind the outlet nozzle of the pump.

Double-acting mechanical seal

Two pairs of stationary seal rings and rotating seal rings are used to increase the safety of the shaft seal. A zero emission of the pumped medium can be achieved by a suitable arrangement and associated sealing pressure system. If one of the two mechanical seals is destroyed, the pumped medium will not escape unhindered into the atmosphere.

Dry running

Condition in which the sealing gap between the rings is not or not sufficiently filled with liquid. This can be caused by the absence of liquid (e.g. accumulation of gas bubbles around the mechanical seal) or by excessive axial contact forces between the rotating seal ring and the stationary seal ring. There is then a risk of overheating or uneven heating of the materials involved due to dry friction with often catastrophic damage in the vicinity of the heat source.

Free flow design

Centrifugal pump with recessed impeller enables the pump to handle larger solid particles in the pumped medium without damaging the impeller.

Horizontal centrifugal pump

The position of the pump shaft is horizontal.

Impeller

A rotating disc-shaped member having radially disposed vanes which receive flow in the direction of the axis of rotation and eject it radially thereto. In this process, the blades are flowed around like an aircraft wing and similar effects occur, i.e. there is a pressure difference between the front and rear of the blade. This pressure difference generates a rotational resistance at the rotating impeller, which is compensated by the drive of the pump via the drive torque. Semi-open impellers have back vanes on the back of the cover disc which serve to reduce the axial thrust and to relieve the mechanical seal. Closed impellers can have sealing surfaces to reduce backflow to the suction side or to relieve the mechanical seal chamber, or they can be equipped with blades on the front and rear sides.

Inlet pressure

Pressure at the inlet nozzle of the pump.

Mechanical seal

Sealing of a shaft passage by means of a stationary ring (at the housing) and a rotating ring (on the shaft), which are pressed against each other axially in such a way that both slide against each other during operation of the pump. During operation, a sealing gap develops between the sliding surfaces in which the pumped medium or - in the case of a double-acting mechanical seal - the sealing medium lubricates the sliding surfaces. Due to the minimal sealing gap, the leakage is so small that it is not visible. Drip leakage is usually arising from a damage of the mechanical seal. When the pump is at standstill, the sealing gap disappears completely and the two rings shut off the pumping chamber statically against the escape of liquid. The axially movable ring is called the sliding ring, the other - with a fixed position - is the rotation seal ring. At the WERNERT bellows mechanical seal, the stationary ring is the axially movable sliding ring. The rotating seal ring, which rotates on the shaft and which is not axially movable. This is a stationary mechanical seal.

MS

Refer to mechanical seal

Permissible operating range

The application limits and the order-related operating datas describe the permissible operating range. These are physical properties that affect the specific pump interact with it and delimit a range permitted by the manufacturer or the legislator from a range that is not permitted. Physical properties can be, the required minimum flow rate and the permitted maximum flow rate of the pump, for example. However, both flow rates could also be dependent on other parameters, so they could possibly not be constant.

Plant

A *plant* (related to a pump) or specific *pump plant* is always only that part of a complete process engineering system which comes into contact with parts of the pumped liquid of the specific pump. It makes sense to start and to end this pump system at physically important locations, to start with the inlet tank and to end at the nozzle block of a scrubber system. It often makes sense to divide such system into the suction side and the pressure side again. On suction side a special consideration of cavitation is often necessary, but on pressure side the necessary pressure build-up of the pump is usually in the foreground. Both calculations require great care and good process engineering knowledge in order to ensure safe and efficient operation of the pump.

Process design

Enables the removal and replacement of the complete back pullout unit without dismantling the piping and the motor.

Sealing pressure

refer to sealing pressure system

Sealing pressure system

Such a system essentially consists of a pressure vessel with a volume of approx. 8-9 liters, which is installed at a height of approx. 1 - 2 m above the mechanical seal. The pressure vessel must be filled with sealing liquid within the permissible filling levels, above the sealing liquid the vessel is pressurised with gas (usually nitrogen). Sometimes the gas is separated from the barrier liquid by a rubber balloon. Since the gas is under pressure, this pressure is transferred to the sealing liquid (sealing pressure). If the pressure vessel is connected at its lowest point via a thin pipe to the sealing chamber of the double-acting mechanical seal in the pump, the sealing liquid flows into the sealing chamber between the seal ring pairs and builds up the sealing pressure there. Friction and other heat transfer causes the sealing liquid to heat up and to expand. This effect is exploited to return the sealing liquid to a higher point in the pressure vessel via another thin pipe connection. This is the natural thermosiphon effect that keeps the barrier fluid in constant circulation. The circulation is usually supported by a delivery thread on the shaft sleeve or by a circulating pump. The heated sealing liquid flows back into the reservoir in the pressure vessel and is cooled there. The pressure vessel in turn cools down at its surface in the ambient air. If this is not sufficient, the cooling coil inside the pressure vessel must also be supplied with cooling liquid. In order to protect the circuit, various sensors (pressure, filling level, temperature) can be arranged on the pressure vessel. It can also be filled with gas and sealing liquid during operation.

Single mechanical seal

Only one pair of sliding ring and rotating seal ring is used. If this mechanical seal is destroyed, the pumped medium will escape unhindered into the atmosphere. Therefore it is subject to legal framework conditions, e.g. guidelines for air pollution control, to decide whether a single-acting mechanical seal is suitable for the application.

Size of bearing housing

Although the EN ISO 2858 standard prescribes the main connection dimensions of a centrifugal pump, it does not explicitly divide the large number of pump sizes into groups. In practice, however, a sensible division into bearing housing sizes from the standardized dimensions has been established. With a suitable system, it is possible to design the 34 sizes with only 4 bearing housing variants (including shaft, bearing and mechanical seal). The smallest bearing housing is called size 1, the largest is called size 4. The bearing housing of pumps which are not covered by the standard due to their small size, but are nevertheless offered as a type of standard centrifugal pump, is often referred to as bearing housing size 0.

Standard EN ISO 2858

Defines the main external connection dimensions and the hydraulic data of the centrifugal pumps in 34 sizes for a maximum working pressure (nominal pressure) of PN 16 (bar). These are single-stage (= one impeller) centrifugal pumps in horizontal design. The internal design of the pumps is not described in the standard.

Suction side

All locations of the installation upstream of the pump, i.e. in front of the inlet nozzle of the pump.

Vapor pressure

Depending strongly on the temperature, each pumped medium has a certain vapour pressure. If the pressure is falling below, e.g. due to pressure losses in pipelines or valves, gas will escape from the pumped liquid as a reaction. This process is called cavitation. Cavitation occurs in particular inside pumps, as pumps initially reduce the pressure in the pumped liquid before they build up pressure. Therefore, there must always be a sufficient pressure difference to the vapor pressure at the inlet of the pump. This differential pressure, expressed in meters of head, is known as the NPSH value of the plant. The NPSH value of the pump must be strictly distinguished from that. This corresponds to the pressure reduction within the pump and is measured and defined by the manufacturer. The NPSH value of the pump must always be smaller than the NPSH value of the plant. Only then no cavitation will occur inside the pump. Cavitation gases can lead to dry running of the mechanical seal. If the cavitation gases (in the form of bubbles) collapse in the zones of the pump at high pressure, damage of material can occur there. Profound cavitation within a pump is noticeable as a clear crackling noise and, like any gas entry, can lead to considerable reductions in flow rate and head.

Vertical centrifugal pump

The position of the pump shaft is vertical.

1. General

IMPORTANT
READ CAREFULLY BEFORE USE
KEEP FOR FUTURE REFERENCE

1.1 Principles

For the safe and proper use of this machine, these operating instructions must be understood and applied in all phases of the product's life.

The design of the machine is described in detail in the order confirmation. The most important data are listed on the nameplate. The pump or pump unit can be uniquely identified by the serial number of the pump.

In order to maintain possible warranty claims, the manufacturer must be informed immediately in the event of damage.

1.2 Target group

The target group for these operating instructions is technically trained specialist personnel. (⇒ section 2.2)

1.3 Symbols

Symbols	Meaning
✓	Precondition for the action
➤	Call to action
⇒	Cross reference
1. 2.	Multi-step instructions for action
	Notice to recommendations and important information for handling the product

1.4 Intended use of the pump

This standard chemical pump is a horizontally mounted machine for pumping liquids. It is designed for the operating point specified on the nameplate and the operating data specified in the technical data sheets and is always only intended for installation in a corresponding plant. Since the pumped liquids are usually hazardous (toxic, flammable, corrosive), it is particularly important to observe the safety instructions contained in these operating instructions.

1.5 Validity of the operating instructions

These operating instructions are valid for the type series specified in the cover sheet of the standard construction variants. We reserve the right to make technical changes without notice. For special designs and variants, please refer to the order-specific documentation. In case of doubt, please contact the manufacturer. Operating instructions and documents for accessories and components must also be observed.

1.6 Documentation

The following documents belong to the standard scope of delivery of the pump:

- Operating instructions
- Sectional drawing
- Spare parts list

Hydraulic characteristic curve

If the pump is placed on the market in the European Union: Declaration of conformity according to EC Directive 2006/42/EC (Machinery Directive)

1.7 Declarations

1.7.1 Declaration of conformity for pumps according to directive 2006/42/EC for machines

Sample of content

Declaration of conformity

Manufacturer:

WERNERT-PUMPEN GMBH

Oberhausener Str. 67-79

45476 Mülheim an der Ruhr - Germany

Subject of the declaration

Product model/product

Standard chemical pump

Type:

Serial number:

The object of the declaration described above is in conformity with the relevant Union harmonisation legislation:

DIRECTIVE 2006/42/EG

on machinery

References to the relevant harmonised standards used or references to the other technical specifications in relation to which conformity is declared:

EN ISO 12100:2010, EN 12162:2001+A1:2009

EN 809:2012-10, EN ISO 13857:2008, EN ISO 2858:2010

Signed for and on behalf of:

WERNERT-PUMPEN GMBH

ppa. Christian Wallrodt

Head of Engineering and Sales

Mülheim an der Ruhr, 20.03.2018

1.8 Technical design

This pump is a horizontal centrifugal pump with axial inlet PN 16 according to the standard EN ISO 2858:2010. A mechanical seal (MS) is provided as shaft seal.

Pump sizes NE 40-25-160 and NE 250-200-400 have been designed following DIN EN ISO 2858:2011-12 (trans-standard pumps).

The dimensions "f" and "w" of pumps in torque flow design (hydraulic design identification F) do not comply with the standard DIN EN ISO 2858:2010. They are longer in the axial direction, other dimensions are identical.

1.9 Type description

The type description is made up of a four letter code and the size as defined by standard DIN EN ISO 2858:2010.

NE	P	O	200	-150	-250	<p>D Optional. If applicable: Pump is designed for use with throttling bush. (⇒ section 5.3.6).</p> <p>VB Optional. If applicable: The pump is designed for use with a priming tank (⇒ section 5.3.4).</p>
						Nominal impeller diameter: This does not correspond to the impeller diameter installed. The installed impeller diameter can be found on the nameplate or parts list.
						Nominal diameter discharge side, here DN 150
						Nominal diameter suction side, here DN 200
						<p>4th letter Hydraulic design:</p> <p>D = semi-open impeller with physically bent blades</p> <p>E = semi-open impeller with increased head</p> <p>F = semi-open impeller in torque flow model</p> <p>G = closed impeller with sealing strips</p> <p>O = semi-open impeller</p> <p>S = closed impeller with front and back vanes</p> <p>X = Special hydraulics</p>
						<p>3rd letter Main material:</p> <p>A = PTFE, conductive or PFA, conductive</p> <p>B = Polypropylene (PP)</p> <p>H = Hawiflex®, Polyurethan</p> <p>K = Polyvinylidenfluoride (PVDF)</p> <p>L = UHMW-PE conductive</p> <p>P = ultra high molecular low pressure polyethylene (UHMW-PE)</p> <p>T = Polytetrafluorethylene (PTFE) or Perfluoralkoxy (PFA)</p> <p>W = reinforced mineral cast Wernit®</p>
						Type series designation, here NE

1.10 Type plate

A nameplate is attached to each pump. It contains the following information:

- Name and address of the company WERNERT as manufacturer
- Type description
- Serial number of the pump
- Impeller diameter, impeller blade height and number of blades
- Diameter of a possibly used throttling bush
- Designed volume flow [m³/h] and associated delivery head [m]
- Necessary coupling power and nominal power of driver [kW]
- Nominal speed
- Density of the liquid to be pumped
- Data regarding the mechanical seal used
- Year of construction
- CE marking

A pump that is approved for use in a potentially explosive atmosphere in accordance with Directive 2014/34/EU (ATEX) will get an additional nameplate.

Explanations on the nameplate can be found in ⇒ chapter 10.

1.11 Liability

No warranty is furnished for any damages due to the following reasons: Unsuitable or improper use, incorrect mounting and/or commissioning by the customer or any third party, natural wear and tear, incorrect or negligent treatment, unsuitable operational equipment, exchange materials, defective construction work, unsuitable subsoil, chemical, electro-chemical or electric influences unless attributable to a fault of the supplier's.

2. Safety

These operating instructions contain basic information for all phases of the machine's life which must be observed. Therefore, these operating instructions must be observed by the respective specialist personnel/operator and must always be available at the place of operation of the machine/plant.

Not only the safety instructions listed under this section "Safety" must be observed, but also the special safety instructions inserted under the other sections.

2.1 Marking of warnings







Symbol	Bedeutung
 DANGER	DANGER This signal word indicates a hazard with a high degree of risk which, if not avoided, will result in death or serious injury.
 WARNING	WARNING This signal word describes the hazard with a medium degree of risk which, if not avoided, can result in death or serious injury.
 CAUTION	CAUTION This signal word denotes the hazard with a low degree of risk which, if not avoided, may result in minor or moderate injury.
	EXPLOSION PROTECTION This symbol provides information on protection against the occurrence of explosions in potentially explosive atmospheres in accordance with Directive 2014/34/EU (ATEX).
	DANGEROUS ELECTRICAL VOLTAGE In combination with a signal word, this symbol indicates dangers in connection with electrical voltage and provides information on protection against electrical voltage.
 ATTENTION	RISK OF MACHINE DAMAGE This symbol indicates in combination with the signal word ATTENTION dangers to the machine and its function.
 ATTENTION	RISK OF ENVIRONMENTAL DAMAGE This symbol indicates in combination with the signal word ATTENTION environmental hazards.

Table 2.1: Meaning of signal words and warnings

Instructions and markings on the machine must be observed and kept in a legible condition. This applies, for example, to:

- Instructions
- Rotation arrow
- Markings for connections
- Name plate

2.2 Personnel qualification and training

The personnel for operation, maintenance, inspection and mounting must have the corresponding qualification for these operations.

Range of liability, competence and the supervision of the personnel must be exactly defined by the user. If the personnel do not have the required knowledge, same must be trained and instructed. If required, this may be effected by the manufacturer/supplier on behalf of the machine user. In addition, it must be ensured by the user that the contents of this operation manual and the operation manuals of the plant are fully understood by the personnel.

2.3 Dangers in case of non-compliance with the safety hints

Non-compliance with the safety hints may result not only in danger to personnel, but also to environment and machine. Non-compliance with the safety hints may lead to the loss of any claims for damages.

In detail, non-compliance may, for example, entail the following dangers:

- Failure of important functions of the machine/plant
- Failure of specified methods for maintenance and servicing
- Danger to personnel by electrical, mechanical, magnetic, thermal or chemical influences as well as by explosion
- Danger to the environment by leakage of dangerous substances







2.4 Responsible working

The safety hints mentioned in this operation manual, the current national rules for the prevention of accidents as well as any internal working, operating and safety regulations of the user must be observed.

In addition, please note:

- Applicable standards, guidelines and laws
- In potentially explosive atmospheres: explosion protection regulations
- Safety regulations for handling hazardous substances

2.5 Safety hints for the user/operator

 CAUTION	<p>Danger from hot and cold surfaces</p> <p>Burning of the skin. Bearing housing, mechanical seal and pump casing can become very hot. Cold metallic surfaces can cause skin damage at frost.</p> <ul style="list-style-type: none"> ✓ The operator must protect hot surfaces against contact - EN ISO 13857. ✓ Wear protective clothing, gloves.
 WARNING	<p>Danger from rotating parts</p> <p>Rotating parts of the mechanical seal, shaft and coupling.</p> <ul style="list-style-type: none"> ✓ Touching protections must be mounted during operation. ✓ If protective devices such as the touching protection are to be removed, it must be ensured beforehand and until reassembly that the motor cannot be put into operation.
 DANGER	<p>Danger from leaking liquid</p> <p>Splashing fluid can injure skin and eyes. Pumped medium can be hazardous to health: e.g. toxic, hot, explosive.</p> <ul style="list-style-type: none"> ✓ Touching protections and splash guards must be installed during operation. ✓ Connect pipe connections and supply lines properly. ✓ Wear protective clothing suitable for the pumped medium, e.g. protective goggles, gloves, acid protection suit.
 ATTENTION	<p>Dangerous goods</p> <p>Leakage at mechanical seal or other pump parts.</p> <ul style="list-style-type: none"> ✓ Hazardous materials must be suitably collected and disposed of.
 DANGER	<p>Danger from electrical energy</p> <p>Protection against dangerous body currents and electric shock.</p> <ul style="list-style-type: none"> ✓ Laws, regulations, rules and specifications of the local energy supply companies must be observed. ✓ Activities may only be carried out by competent persons.
 DANGER	<p>Risk of explosion</p> <p>Hazards which could lead to explosion hazards must be prevented.</p> <ul style="list-style-type: none"> ✓ Directives and standards for hazardous areas must be observed by the operator. ✓ No operating conditions must occur which could result in inadmissibly high surface temperatures. ✓ Sparking, discharge must be prevented.

2.6 Safety instructions for maintenance, inspection and assembly work

The operator shall ensure that all maintenance, inspection and mounting operations are performed by authorised and qualified expert personnel who have studied the operating instructions carefully and obtained sufficient information.

In principle, work on the machine must only be carried out at a standstill.

The procedure described in the operating instructions for stopping the machine must be strictly adhered to (⇒ section 6.4).

The pump must have reached ambient temperature and be depressurized and emptied.

Pumps pumping media injurious to health must be decontaminated.

Immediately upon completion of the work, all safety and protective devices must be refitted or made operational again. Prior to restarting, the points listed in ⇒ chapter 6, Commissioning, must be observed.

2.7 Unauthorized conversion and spare parts production

The machine may only be converted or modified after consultation with the manufacturer. Original spare parts and accessories authorised by the manufacturer serve safety purposes. The use of other parts may cancel the liability for the consequences resulting therefrom.

2.8 Permissible operating modes

Safe working conditions of the machine supplied is ensured only in case of intended use in line with this operation manual. The service limits specified in order related documents and under (⇒ section 4.2) must by no means exceeded or fallen below. Order-related documents have priority.

2.9 Explosion protection



If the pumps are used in potentially explosive atmospheres, the measures and instructions attached to the pump and described in the following sections as well as the safety instructions marked with the ex symbol must be observed to ensure explosion protection. Standard EN 1127-1 must be observed (explosion protection).

2.9.1 Identifying marking

Pumps intended for use in potentially explosive atmospheres must be marked in accordance with Directive 2014/34/EU (⇒ section 10.1.1) and the declaration of conformity in accordance with Directive 2014/34/EU must be available. The marking refers only to the pump. Coupling and motor must be marked separately according to directive 2014/34/EU and their declarations of conformity according to directive 2014/34/EU must also be available.

2.9.2 Filling of pump

During pump operation, the interior pump space in contact with the liquid must be constantly filled with the medium pumped. In particular, the accumulation of air in the pump must be safely avoided by suitable process control and piping.

2.9.3 Modes of operation affecting the explosion protection

Dangers affecting the explosion protection have to be avoided. Unintended use may lead to exceeding the admissible surface temperature or to sparks, which may result in a possible ignition. Friction on non-conducting surfaces is to be avoided.

 DANGER	<p>Risk of explosion due to inadmissible operating conditions</p> <p>Operation with closed shut-off devices in the suction and/or discharge line is not admissible. In this state, there is a danger that - after a short period of time - the medium pumped takes inadmissible temperatures and the maximum admissible surface temperature is exceeded. In consequence a rapid pressure rise inside the pump may lead to the destruction and even bursting of the pump.</p> <ul style="list-style-type: none"> ✓ The specified minimum volume flow must by all means be maintained (⇒ section 4.2.4). ✓ Pumps may only be operated within the permissible operating range. <p>Dry running is not admissible. In case of dry running or lack of lubrication, sufficient lubrication and cooling of the mechanical seal is not possible. In such a case, the maximum admissible temperature limit may also be exceeded.</p> <ul style="list-style-type: none"> ✓ Dry running is not permitted and must be prevented. ✓ The pump chamber must be completely filled with the pumped medium. ✓ The pumped medium must not contain any gas components (⇒ section 4.2.5). ✓ Keep pressure losses on the suction side as low as possible. Monitor suction-side filters with differential pressure measurement. Avoid filters on the suction side if possible. ✓ The vapour pressure of the pumped medium must not fall below this value. If the vapour pressure falls below this value, a gas ring may form on the mechanical seal. The higher the temperature and the lower the pressure, the greater is the risk that the vapour pressure will fall below. ✓ The inlet pressure must be large enough to prevent any negative pressure at the mechanical seal. ✓ If there is a risk of dry running, use a double-acting mechanical seal if possible. ✓ Operate the pump within the permissible operating range. ✓ The valve on the suction side must be completely open during operation. The flow rate may only be adjusted via the pressure-side valve or the speed. ✓ The required pressure and volume flow at additional connections such as sealing liquid, flushing liquid etc. must be guaranteed by the operator (⇒ sections 5.4 und 7.3). This applies in particular to quench and barrier fluid. Here, sufficient cooling and lubrication of the radial shaft seal or the mechanical seal must be ensured. <p>Avoid other possible ignition sources.</p> <ul style="list-style-type: none"> ✓ Mechanically generated sparks, electrical sparks, static electricity, discharge must be prevented. <p>Risk of inadmissibly high temperatures due to inadequate lubrication of roller bearings and seals.</p> <ul style="list-style-type: none"> ✓ Observe inspection and maintenance intervals (⇒ sections 7.2.3). ✓ Filling levels, pressures, temperatures at supply facilities for barrier fluid, flushing fluid and quench tanks must correspond to the specifications of the operating instructions or the technical data sheet.
---	---

2.9.4 Explosion protection group

Pumps with marking (please refer to ⇒ section 2.9.1 above) correspond to Group II, i.e. they are provided for employment in explosive atmospheres. In this group, the usage in underground plants of mines and their above-ground plants is excluded.

2.9.5 Equipment category

Identifying marking	Category description	Suitability for zone
2G	Category 2G equipment is intended for use in areas where an explosive atmosphere consisting of gases, vapours and mists is likely to occur occasionally.	Zone 1

2.9.6 Temperature class

If the maximum surface temperature mainly depends on the operating conditions (heated liquid in the pump, see temperature limits ⇒ chapter 2.9.7), the device must be marked with a range of temperature classes (EN ISO 80079–36, 6.2.5).

Possible temperature classes of pumps with marking according to ⇒ chapter 2.9.1 in execution:

Bearing lubrication	Medium temperature ¹⁾	approved for temperature class
Oil lubrication	≤ 160 °C	T3
Grease, lifetime-lubricated	≤ 160 °C	T3
Grease, relubricable	≤ 160 °C	T3
Oil lubrication	≤ 100 °C	T3 ... T4
Grease, lifetime-lubricated	≤ 100 °C	T3 ... T4
Grease, relubricable	≤ 100 °C	T3

¹⁾ The maximum permissible medium temperatures due to the material of the pump housing and the bellows (⇒ section 4.2.2) must be observed.

The type of the bearing lubrication can be found in the parts list or obtained from the manufacturer by indicating the serial number.

2.9.7 Temperature limits (due to explosion protection)

⚠ DANGER	<p>Impermissible surface temperatures</p> <p>Explosion hazard!</p> <ul style="list-style-type: none"> ✓ Only operate the pump within the permissible ambient temperatures. ✓ Observe the maximum permissible temperature of the pumped medium depending on the type of lubrication, the material of the pump casing, the material of the bellows or mechanical seal and the O-rings (⇒ section 4.2.2).

Depending on the pump design, the maximum permissible temperature of the pumped liquid may also be below the following values (⇒ section 4.2.2).

Temperature class to EN ISO 80079-36, 6.2.5 Group II equipment	Maximum surface temperature °C	Maximum temperature of the pumped liquid °C
T1	450	165
T2	300	165
T3	200	160
T4	135	100
T5	100	*)
T6	85	*)

Tab. 2.1 Temperature classes

*) Consultation with the manufacturer is required.

The permissible temperature class depends on the lubrication of the bearing (⇒ section 2.9.6).

2.9.8 Pumping of inflammable media, conductivity

Pumps by means of which inflammable media are to be pumped must not be equipped with a single-acting mechanical seal unless the operator, due to suitable control systems, is in a position to assure that no danger can be brought about by the medium pumped. The manufacturer must be contacted. Here, the use of a double-acting mechanical seal is to be preferred. The required sealing pressure system must be designed and operated with pressure, volume flow and temperature, if necessary, according to the requirements of the mechanical seal. The specification of the sealing medium and the operating instructions for the sealing pressure system must be complied with.

The requirement in ⇒ section 2.9.9 must be noted with regard to the lubricant for the mechanical seal. This applies both with "interior rinsing" for the pumped medium and with "exterior rinsing" for the sealing medium of the double-acting mechanical seal.

 DANGER	<p>Conductivity of pumped medium too low</p> <p>Explosion hazard due to propagating brush discharges.</p> <p>Propagating brush discharges can occur after high charging of non-conductive layers or coatings on metallic surfaces.</p> <ul style="list-style-type: none"> ✓ Observe the minimum conductivity of the pumped medium according to TRGS 727 resp. international standards and guidelines. ✓ The pumped medium must have a high conductivity (> 1000 pS/m). ➤ The pump must be antistatic for pumping non-conductive fluids.
---	--

2.9.9 Lubricants, coolants

The following points must be noted with regard to the oils and grease used to lubricate and cool bearings, as well as with regard to the lubricants for the mechanical seal:

Lubricants and/or coolants which are required to avoid explosive hot surfaces (here: medium pumped or sealing medium to cool and lubricate the mechanical seal) or mechanical sparks (please refer to EN 13463-8) must have an ignition temperature of at least 50 K above the maximum surface temperature of the equipment in which the liquid is used (EN ISO 80079-37).

2.9.10 Maintenance

 DANGER	<p>Impermissible surface temperatures</p> <p>Explosion hazard. Premature wear.</p> <p>In the event of inadequate lubrication or defective bearings, there is a risk that the maximum permissible surface temperature may be exceeded or that sparks may form due to friction.</p> <ul style="list-style-type: none"> ✓ For safe and reliable operation, the pump or pump unit must be properly maintained and kept in a technically perfect condition. The relubrication and replacement intervals (⇒ section 7.2.3) of the bearings must be observed. ✓ The maximum permissible temperature of the pumped medium according to the type of lubrication, material of the pump casing, material of the bellows or mechanical seal and the O-rings must be observed (⇒ section 4.2.2). ✓ Clean the bearing housing at suitable intervals according to the ambient conditions. ✓ The function of the mechanical seal and the supply of the additional connections (⇒ chapters 5.4 and 7.3) must be ensured by the operator through regular checks.
---	---

2.9.11 Coating thickness

For pumps in equipment group II intended for use with gases and vapours in group IIC, the maximum permissible paint thickness is 200 µm. The maximum permissible paint thickness must still be adhered to in the event of a possible repainting.

2.9.12 Chemical compatibility, thermal resistance, pressure resistance

Before commissioning, the operator must check that the materials of the pump and other components are suitable both chemically and thermally for the pumped medium and for other supply media of the mechanical seal and, if necessary, for a chemically aggressive environment. The materials of the pump can be found in the parts list.

Pressurized components must be designed for the expected pressures. This applies in particular to supply units, hose and pipe connections.

2.9.13 Replacement of devices of a pump unit

In order to maintain the conformity and safety of the machine, devices of a pump unit may only be exchanged for suitable devices. The following criteria must be observed:

- The device must comply with the identical or a higher explosion protection type.
- The certificate of conformity and the marking must be available for the new device.
- Changes in geometry, material, thermal and mechanical properties must not result in any hazards due to mechanically generated sparks or hot surfaces.

If the above criteria are not met, the declaration of conformity and CE marking are invalid. The ignition hazard assessment must be re-created and the declaration of conformity for the modified pump unit must be re-issued.

3. Transport, intermediate storage, disposal

3.1 Transport of pumps and pump units

 DANGER	<p>The pump or pump unit slips out of the transport device.</p> <p>Danger from falling parts.</p> <ul style="list-style-type: none">✓ Observe weight specifications and centre of gravity. The weight of the pump can be found in the appendix or on the nameplate of the pump. The total weight of a pump unit must be taken into account.✓ Observe local accident prevention regulations.✓ Only use suitable and permissible load handling attachments. Lifting gear and load-bearing equipment must be suitable for the weight to be lifted.✓ The pump or pump unit must be transported properly.✓ The pump or pump unit must remain in a horizontal position during transport and must not slip out.✓ When transporting a pump unit, it is forbidden to use the ring bolts of the motor.✓ During transport, the pump components must not be subjected to any impact or shock loads.✓ Observe the attachment points for hoists as shown in the following illustrations.
---	---

Figs. 3.1 and 3.2 show possible attachment points for hoists when transporting a single pump and when transporting a pre-assembled pump unit.

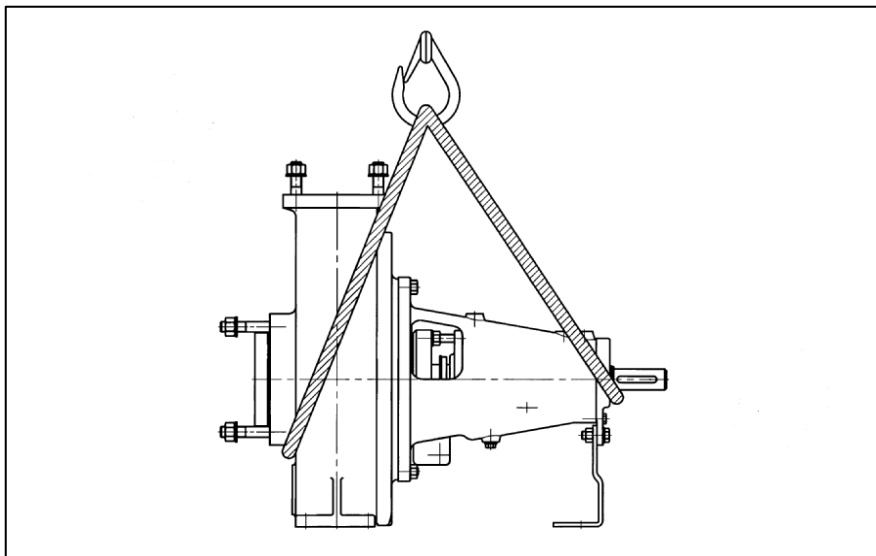

Fig. 3.1 Transport of a single pump

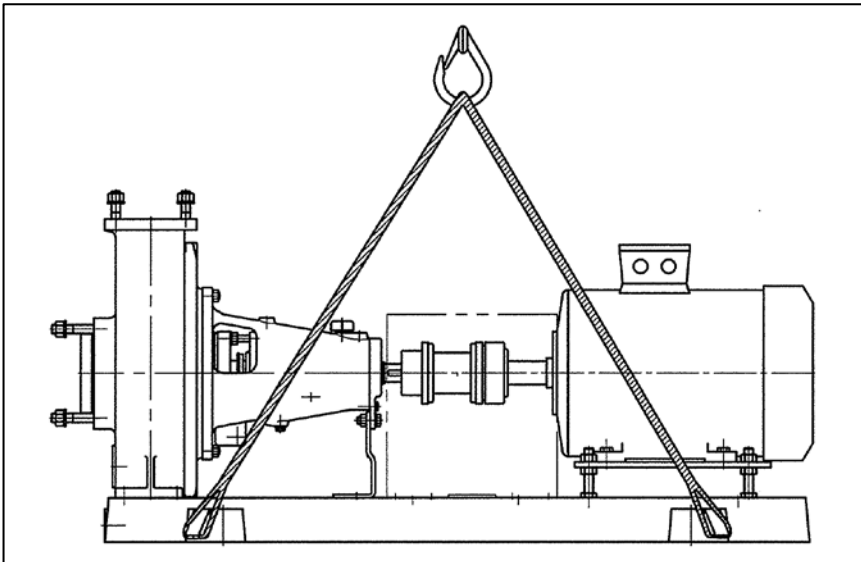



Fig. 3.2 Transport of a pump unit

3.2 Storage

The stability of the intermediate or stored pump must be guaranteed at all times. If the support foot on the bearing housing does not reach the ground or is not mounted, the bearing housing must be suitable and permanently supported in order to ensure a safe standing. The pump unit (pump with motor on base plate) is mounted horizontally.

3.2.1 Intermediate storage under normal ambient conditions

Under normal ambient conditions, i.e. in the temperature range of -10 °C to +40 °C, no special precautions need to be taken for intermediate storage.

 <p>ATTENTION</p>	<p>Damage due to liquid residues, soiling</p> <p>Contamination by foreign bodies in the pump housing and connecting lines. Damage due to liquid residues.</p> <ul style="list-style-type: none"> ✓ No acid or alkali residues must remain in the pump. Crystallization may cause damage to the mechanical seal. ✓ No water must remain in the pump. Risk of freezing. ✓ Do not fill plastic pump with liquid preservatives. ✓ Close pump openings with sealing caps or blind flanges. ✓ Seal other connections with plugs. ✓ Protect the pump from unusual weather and environmental influences.
 <p>ATTENTION</p>	<p>Impact or shock loading</p> <p>Damage to the machine from the outside.</p> <ul style="list-style-type: none"> ✓ Protect the pump from impact and shock loads, if necessary with solid wooden packing.

3.2.2 Intermediate storage under special ambient conditions

Special ambient conditions are:

- Ambient temperatures below -10 °C or above +40 °C.
- Intermediate storage and outdoor installation.
- Particularly high or very low humidity (e.g. tropical or desert atmosphere).
- Intermediate storage in an environment with corrosive fractions in the atmosphere (e.g. sea air or corrosive gases and aerosols).

In addition to the protective measures for normal ambient conditions, these must also be provided:

- Special protection against impact and shock by solid wooden packing.
- Storage in areas not directly exposed to weather conditions. Install protective roofs if necessary.
- Separate packing of the pumps with protective films and use of moisture binding agents.

- Use of anti-corrosion coatings on uncovered metal parts exposed to the atmosphere.

In individual cases, the manufacturer must be consulted regarding intermediate storage measures to be taken under special ambient conditions.

3.2.3 Longer-term storage

For storage periods of more than one year, it must be ensured that sufficient protection is provided against mechanical and climatic stresses. The suction and discharge pump openings must be kept closed. The condition of the packing (wooden box, packing foil, etc.) must be checked regularly, at least once a year, and repaired if necessary.

If moisture binders are used, they must be replaced at least once a year. Uncovered pump components exposed to atmosphere, such as shaft and coupling, must be provided with a corrosion protection coat.

After a storage period of two years, lifetime-lubricated rolling bearings must generally be replaced.

The condition of the bearing grease or oil must be checked prior to commissioning pumps which have been stored for a longer period of time. After a storage period of two years, the bearing lubricant must generally be exchanged.

Under climatic conditions of low humidity, the elastic properties of bellows and sealing elements made of elastomeric materials may be reduced. These parts must then be replaced after several years of storage.



If the pump remains out of operation for a minimum period of six months, the pump shaft must be turned into a different position every three months by several manual rotations so as to avoid any pressure marks on the rolling bearings.

The mechanical seal has to be checked after two years.

3.3 Return to the manufacturer

1. The pump must be drained in accordance with the description for permanent shutdown (⇒ section 6.5).
2. Flush and decontaminate pump, empty completely and clean inside and outside. There must be no substances in the pump that are hazardous to people or the environment.
3. A completed and signed certificate of harmlessness must be supplied with the pump (➤ request from the manufacturer).

3.4 Recycling and disposal

 <p>ATTENTION</p>	<p>Hazardous and/or hot pumped media, barrier and flushing media, lubricants Risk to persons and the environment.</p> <ul style="list-style-type: none"> ✓ Wear suitable protective clothing. ✓ Empty pump, supply lines and connections completely and clean. ✓ Collect residual media. ✓ Avoid contact with pumped medium and residual media. ✓ Dispose of hazardous materials in accordance with local regulations. ✓ The pumped medium may have penetrated plastic parts by diffusion.
	<p>Notice The following applies to the disposal of residual media, the pump and components of a pump unit: The operator is responsible for proper disposal in accordance with local regulations, laws, guidelines and provisions.</p>

4. Description of product and accessories

4.1 General description

Horizontal centrifugal pump according to EN ISO 2858:2010 (chemical pump standard) in process design. The wetted parts are made of plastic or other suitable materials, the selection of which depends on the respective chemical, thermal and mechanical stress. All static plastic parts are metallically surrounded or supported.

In the standard version, a half-open impeller (without cover disc) is provided, but as a special version the installation of a closed impeller (with cover plate) is also possible. For bearing housing size IV, the standard version is a closed impeller. The axial thrust is reduced by back vanes in case of a semi-open impeller and by sealing gaps in case of a closed impeller. A WERNERT bellows mechanical seal is generally used as a shaft seal. For special applications, however, it is also possible to install mechanical seals of other manufacturers.

4.2 Application limits

4.2.1 Maximum permissible test pressure

The static test pressure is determined in accordance with EN 12162 as 1.3 to 1.5 times the maximum delivery pressure, but a maximum of 24 bar, and can be used up to the temperature limit specified in ⇒ section 4.2.3. The maximum permissible test pressure depends on the design of the mechanical seal and must be observed, see also leak test (⇒ section 7.5).

4.2.2 Maximum permissible operating pressure

Temperature of the pumped liquid	Max. permissible operating pressure
≤ 115 °C	16 bar
> 115 °C	10 bar

Operating conditions deviating from these must be agreed separately with the manufacturer.

In the version with drain connection, the permissible operating pressure is 10 bar.

Since the pump is not intended for general use but for a specific application, the permissible operating pressure must be calculated in each case (⇒ section 7.5).

4.2.3 Permissible temperatures

<u>Ambient</u>	min. -10 °C
	max. 40 °C

<u>Pumped medium</u>	lowest temperature	
	for all materials and executions	min. -10 °C

Depending on the execution of the pump, the maximum permissible temperature for the pumped medium is determined by the lowest temperature of the following properties:

Temperature class according to EN ISO 80079-36:2016, Group II devices

1. Assignment of the suitable type of lubrication

T3: all types of lubrication	max. 160 °C
T4: Oil lubrication	max. 100 °C
T4: grease, lifetime lubricated	max. 100 °C



2. Material Pump housing

UHMW-PE, conductive and non-conductive	max. 90 °C
PVDF	max. 115 °C
PP	max. 95 °C
PTFE	max. 160 °C
PFA	max. 160 °C
WERNIT®	max. 125 °C
Durapox®	max. 125 °C
Hawiflex®	max. 80 °C

3. Material of bellows or mechanical seal

EPDM	max. 80 °C	
FPM	max. 100 °C	
PTFE	max. 115 °C	
CSM	max. 80 °C	
EAGLEBURGMANN HRZ 7, HRZ 13 double-acting or third-party seal	max. 160 °C	1) 1)

4. Material of the O-rings

EPDM	max. 130 °C	
FPM		2)
FFKM		2)
FPM/FEP		2)

- 1) The operating limits described in the data sheet or operating instructions of the respective product must be observed.
2) This material does not limit the permissible temperature of the pumped medium.

4.2.4 Volume flow of the pumped liquid

Unless otherwise specified in the characteristic curves or documentation, the following applies:

For pumps with pressure nozzle diameter \leq DN65 applies:

$$Q_{\min} = 0,1 \times Q_{\text{opt}} \text{ for short-time operation (approx. 5 min.)}$$

$$Q_{\min} = 0,15 \times Q_{\text{opt}} \text{ for continuous operation,}$$

For pumps with pressure nozzle diameter \geq DN80 applies:

$$Q_{\min} = 0,15 \times Q_{\text{opt}} \text{ for short-time operation (approx. 5 min.)}$$

$$Q_{\min} = 0,3 \times Q_{\text{opt}} \text{ for continuous operation,}$$

Q_{\max} = according to characteristic diagram do not exceed rated motor power

Q_{opt} = Volume flow in the optimum efficiency of the characteristic pump curve

In case of a deviating working point, the manufacturer must be consulted.

4.2.5 Maximum admissible gas portion of the pumped liquid

Gas portions in the pumped liquid are only permissible after consulting the manufacturer. Gas portions in the pumped liquid reduce the capacity and the delivery head of the pump.

4.2.6 Maximum dimensions of sporadic solid matters in the liquid pumped

The dimensions of sporadic solid matters in the pumped liquid must not exceed the dimension of half the blade height and/or half of the nominal discharge nozzle diameter, whatever dimension is smaller.

This applies to pumps in free-flow design:

The dimensions of separated solids in the pumped liquid must not exceed half of the nominal discharge nozzle diameter.

4.2.7 Maximum admissible supply pressure for WERNERT bellows-type mechanical seal

The maximum admissible gauge pressure at the suction nozzle of the pump with a WERNERT bellows-type mechanical seal depends on the material of the bellows and the speed of the pump.

Bellows material	Speed up to 1800 1/rpm	Speed over 1800 1/rpm
EPDM	2,5 bar	2 bar
FPM	2,5 bar	2 bar
PTFE	3 bar	2,5 bar
CSM	2,5 bar	2 bar

4.2.8 Maximum speeds

The maximum admissible speed must not be exceeded by mechanical transmission ratios or the employment of a frequency converter. For the maximum permissible speed for the respective pump size please refer to Table B.1 in ⇒ chapter 11.

4.2.9 Degree of protection

The pump complies with type of protection IP 23.

Type of protection for contact against accidental contact and impurities (1st digit)

Digit	Protection against accidental contact	Protection against impurities
2	Protected against insertion of a finger	Protected against solid impurities (diameter over 12.5 mm)

Type of protection against water (2nd digit)

Digit	Protection against water
3	Protection against spray water falling at an angle of up to 60° from the vertical

The pump must not be cleaned with a water jet, nor with a high-pressure or steam cleaner.

4.2.10 Construction

The technical design of the pump or pump unit was determined according to the properties of the pumped medium, the operating data and the ambient conditions.

In the event of a deviation from the agreed properties and ambient conditions, the suitability of the pump or pump unit must be checked before commissioning. In particular, the chemical and thermal resistance must be checked.

4.3 Constructional design

Fig. 4.1 shows a sectional drawing which is representative for all sizes.

4.3.1 Pump casing

The solid pump casing is made of plastic material (part 101) and is completely enclosed by a metal annular casing (part 103). Suction and discharge nozzle are fixed to this pump casing. The suction nozzle is supported by a two part retaining ring (part 506.2), the discharge nozzle is supported by the casing part (part 130) and therefore fixed into the annular casing.

The pump can be designed with a drainage outlet in the area underneath the suction nozzle. This is either closed with a cap or fitted with a fitting (e.g. valve). Drain pipes which are subjected to the pressure of the pump must be suitable for at least PN10.

4.3.2 Impeller

Semi-open wheels are used as impellers (part 233). Semi-open impellers are also suitable for transporting media containing solids. The material used is solid plastic. The torque of the shaft is taken up by a metal hub pressed into the impeller. The impeller is fixed on the shaft in an axial direction by the multiple ring (part 501). A two-part ring is not used for sizes 40–25–160 and bearing support size IV. In this case, the impeller rests on a shoulder of the shaft. Closed impellers can also be used in special cases. Closed

impellers are used as standard design for pumps size IV. The torque absorption of the shaft is then effected via a parallel key connection.

4.3.3 Shaft and bearings

In general, the impeller is connected with the metal shaft (part 210) via a thread. In the sealed area, the shaft is protected by a shaft wearing sleeve (part 524) which is either made of carbon or a ceramic material. This shaft wearing sleeve is tensioned with the rotating seal ring (part 475) via a spanner (part 552.2) which is situated between thrower (part 507) and loose collar (part 505). The shaft's torque is taken up by a feather key connection.

The shaft is supported outside the liquid wetted area in the bearing housing (part 350). The rolling bearing can consist of grease or oil lubrication and is protected by a bearing cover and bearing end cover (parts 360 and 361) with inserted shaft seal rings (parts 420). As standard version we have installed life-time ball bearings. If requested the pumps can also be provided with bearings for regreasing. Additional grease is added via the grease nipples (parts 636). Oil lubrication is installed upon customer request, or if the temperature of the medium to be pumped is greater than 100°C. As standard version we use an oil level sight glass (part 642) for level monitoring. Alternatively the oil level can be regulated by means of a constant level oiler which will be mounted at the side of the bearing housing (part 350).

4.3.4 Sealing the pump

The shaft is sealed using a mechanical seal (MS). Depending on the application, a number of seals are used. These are described in more detail in ⇒ section 4.5. The mechanical seal is taken up in every case by the seal insert (part 443) which also seals the pump casing via the O-ring (part 412.04). Discharge and suction nozzles are also sealed using O-rings (parts 412.01 and 412.03). Gaskets are used in the "WERNIT" version. Additional static seals are installed in the area of the mechanical seal and depend on its design. Usually FPM is used for the O-rings.

4.4 Sectional drawing with part designation

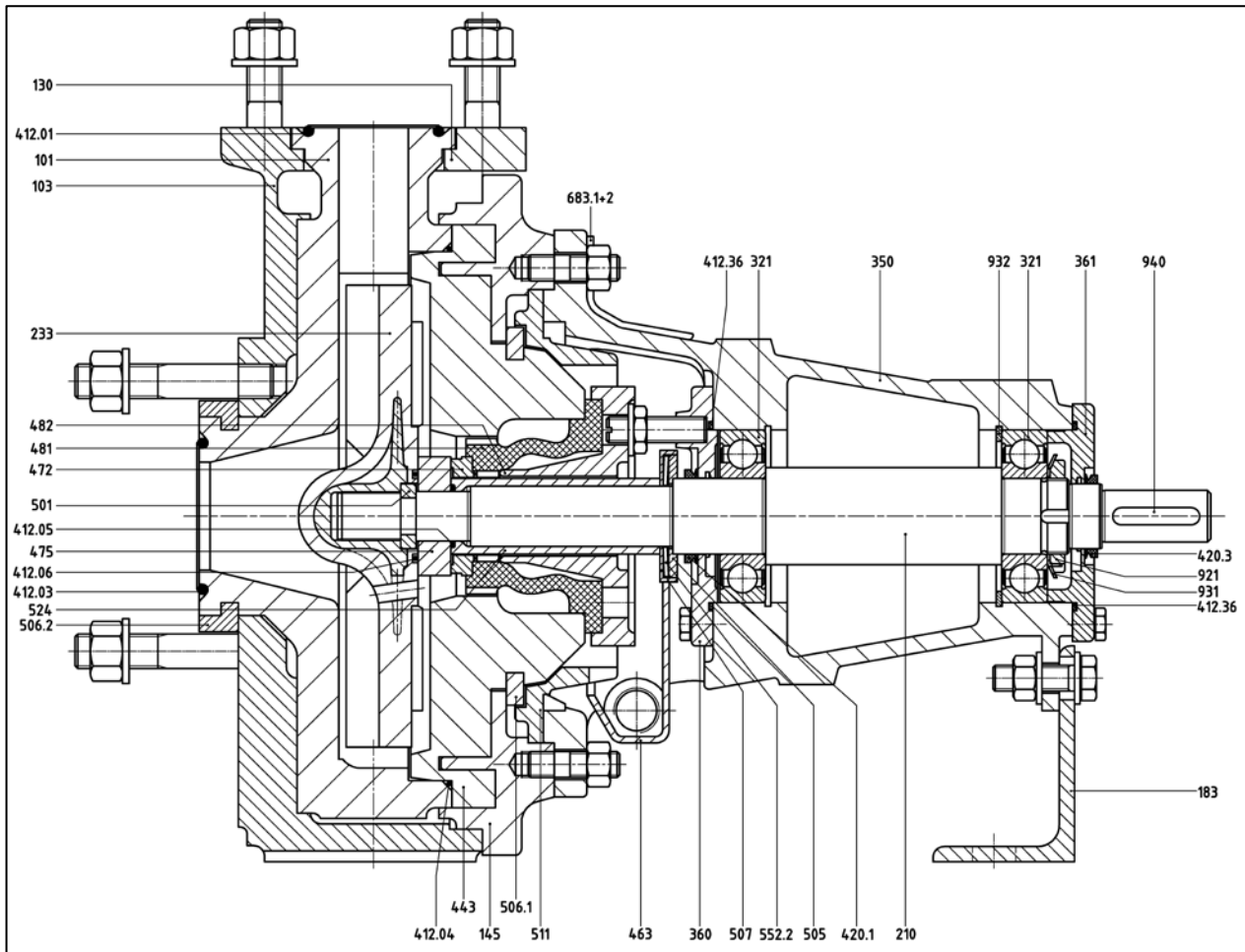

Part No.	Description	Part No.	Description
101	Pump casing	443	Seal insert
103	Annular casing	463	Drip plate
130	Casing part	472	Stationary seal ring
145	Adapter	475	Rotating seal ring
183	Support foot	481	Bellows
210	Shaft	482	Bellows seat
233	Counter clockwise impeller	501	Multiple ring
321	Radial ball bearing	505	Loose collar
350	Bearing housing	506.1	Retaining ring (Seal insert)
360	Bearing cover	506.2	Retaining ring (suction nozzle)
361	Bearing end cover	507	Thrower
412.01	O-Ring	511	Centering ring
412.03	O-Ring	524	Shaft wearing sleeve
412.04	O-Ring	552.2	Spanner (Shaft wearing sleeve)
412.05	O-Ring	683	Cap
412.06	O-Ring	921	Shaft nut
412.36	O-Ring	931	Lockwasher
420.1	Shaft seal ring	932	Circlip
420.3	Shaft seal ring	940	Key

Fig. 4.1 Sectional drawing of the pump with single-acting WERNERT-elastomere-bellows-mechanical seal.

4.5 Designs of mechanical seals

4.5.1 Single WERNERT–elastomere–bellows–mechanical seal (MS)

Usually the pumps are designed using the single WERNERT–elastomere–bellows–mechanical seal. The different designs of this are shown in Fig. 4.2.

The stationary seal ring (part 472) is positioned in the bellows (part 481) made of EPDM or FPM and pressed against the rotating seal ring (part 475) using elastic pretension – supported by the pumping pressure. The static seal of the sealing area is also achieved using the elastic bellows which is positioned between the bellows seat (part 482) and the seal insert (part 443).

a) Interior rinsing – API plan 01 (**Fig. 4.2a and for PTFE bellows 4.3a**)

The model with interior rinsing (product rinsing) is suitable for non–critical applications. Rinsing holes in the impeller and the conical shape of the seal insert in the area of the stationary seal ring, the MS is rinsed with fresh, cool liquid to be pumped (product).



b) Interior rinsing and Quench – API Plan 62 (**Fig. 4.2b and for PTFE bellows 4.3b**)

In this model a radial shaft ring (part 421.2) is built into the bellows seat (part 482) on the atmospheric side. Together with the rotating seal ring on the product side, this creates an area which is supplied with so–called quench liquid which is not under pressure. Usually clean, filtered water, sometimes under higher temperatures, or completely desalinated water is used.

The quenching liquid is meant to prevent crystals being formed on the atmospheric side of the MS when pumping media which can form crystals is being used. This could lead to increased abrasion or if crystals grow, the MS can become increasingly leaky. The quenching device can provide a certain amount of protection against the rotating seal rings overheating in the case of a vacuum in the shaft seal space. This vacuum can be caused by high suction losses or suction heights.

I. Quench, open loop (with continuous flushing)

The quench liquid flow is limited to 30 litres per hour by a built–in flow limiter at overpressures between 0.7 bar and 8.5 bar.

 DANGER	Quench cannot run freely Explosion hazard due to inadmissible temperature! Destruction of the radial seal ring.
	<ul style="list-style-type: none"> ✓ The quench liquid must run off freely. ✓ Avoid increased pipe resistance in the drain. ✓ The pipe must be discharged in such a way that the pressure built up in the quenching chamber does not exceed 0.5 barg.

II. Quench, close loop (stationary quench)

The supply is ensured via a quench tank with connected hose lines to the mechanical seal of the pump. In contrast to the open loop quench, the flow limiter is not required for stationary quench. This allows the following effect to be used. The difference in temperature between the supply and return hose of the stationary quench tank results in a difference in the density of the liquid. The resulting different liquid columns lead to a circulation of the quench liquid. The stationary quench container should be 3/4 filled. The filling level must be checked regularly. Observe notes on the hose connection of the additional connections (⇒ section 5.4).

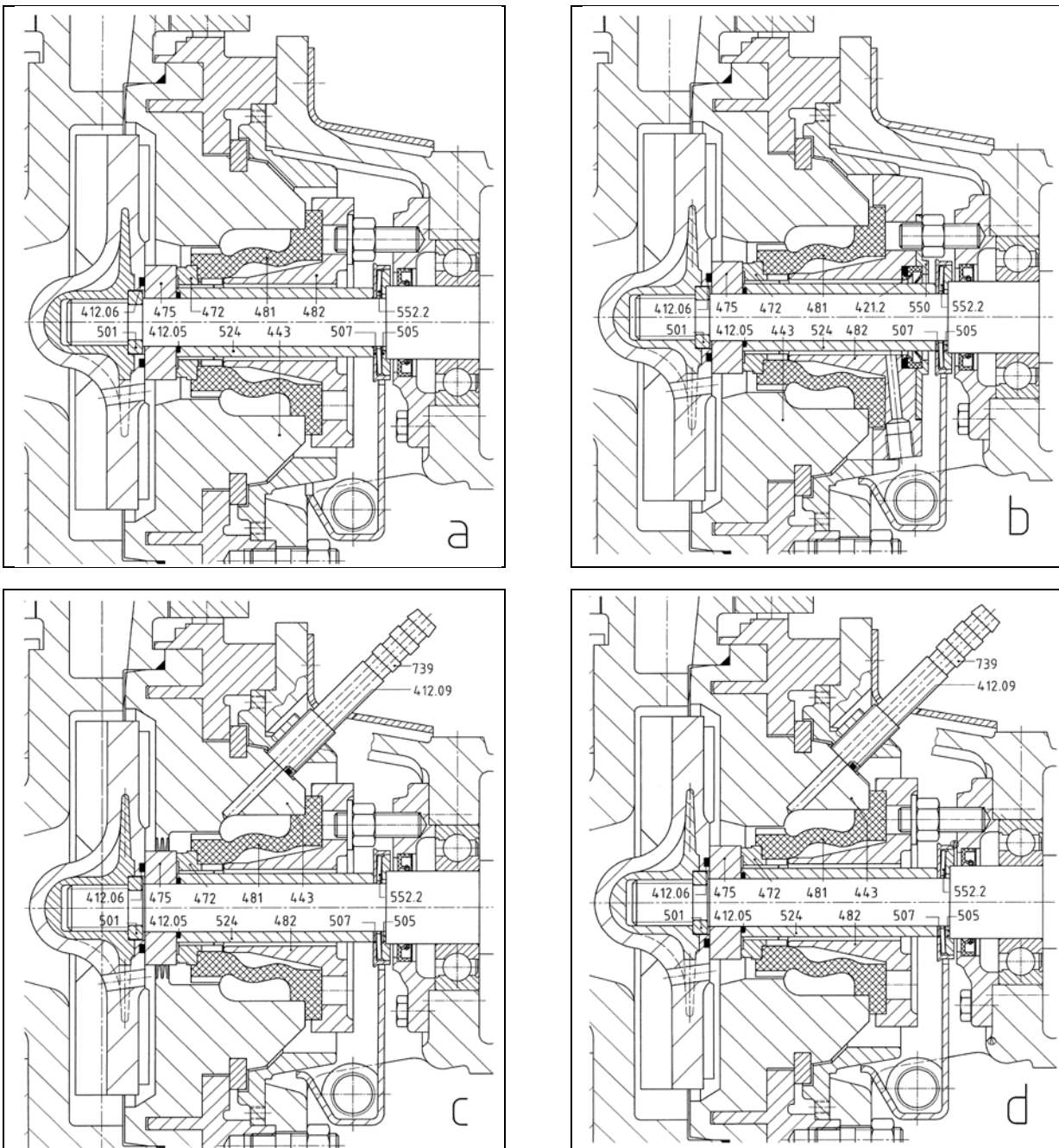

Part No.	Description	Part No.	Description
412.05	O-Ring	482	Bellows seat
412.06	O-Ring	501	Multiple ring
412.09	O-Ring	505	Loose collar
421.2	Radial shaft seal ring	507	Thrower
443	Seal insert	524	Shaft wearing sleeve
472	Stationary seal ring	550	Disc
475	Rotating seal ring	552.2	Spanner
481	Bellows	739	Hose coupling

Fig 4.2 Representation of single WERNERT–elastomere–bellows–mechanical seal

- a) with interior rinsing (product rinsing) of mechanical seal (API Plan 01)
- b) with interior rinsing (product rinsing) and quench (API Plan 62)
- c) with rinsing connection and labyrinth seal (continuous rinsing) (API Plan 32)
- d) with rinsing connection without labyrinth seal for rinsing after use (stationary rinsing)

c) Continuous rinsing – API Plan 32 (Fig. 4.2c and 4.3c)

Pumps to pump polluted liquids can be equipped with a rinsing connection (continuous rinsing) in order to rinse the mechanical seal with clean liquid – usually water – and to keep contaminants away. To limit the flow of rinsing liquid, the shaft sealing space is equipped with a labyrinth seal towards the inside of the pump.

The rinsing quantity is specified by the manufacturer in the order confirmation. The recommended rinsing quantities can also be taken from ⇒ chapter 13. If for technical reasons, the recommended rinsing quantities must be deviated from, please contact the manufacturer.

The installation of a liquid quantity meter (rotameter) in the rinsing liquid line is recommended for the correct quantity to be set. For the regulation of the rinsing liquid flow, a valve must be installed.

d) Rinsing after use (Fig. 4.2d and 4.3d)

Rinsing after use is equivalent to continuous rinsing, the only difference being that there is no labyrinth seal. Stationary rinsing is to be used in those cases where contaminated liquids are to be pumped but where it is not possible to install the continuous flow of rinsing liquid due to system or process constraints. It is used to rinse the pump immediately after it has been switched off. Stationary rinsing is meant to prevent sedimentation and crystallisation processes in the interior of the pump – especially in the area of the mechanical seal, as during longer standing periods the rotating seal ring and the stationary seal ring can stick together. Rinsing volume is 40 l for a rinsing period of 5 minutes (minimum). Normal industrial water can be used for rinsing.

4.5.2 Single WERNERT-PTFE-bellows-mechanical seal

If the fluid excludes the use of bellows made of elastomeres, PTFE bellows-mechanical seals can be used. Fig. 4.3 shows WERNERT-PTFE-bellows-mechanical seals which can be used in place of elastomere bellows without any constructional changes being made to the seal insert. The function and action of the models shown in Figs. 4.3a to d are equivalent to the single WERNERT-elastomere bellows-mechanical seals shown in Fig. 4.2 and described in ⇒ section 4.5.1.

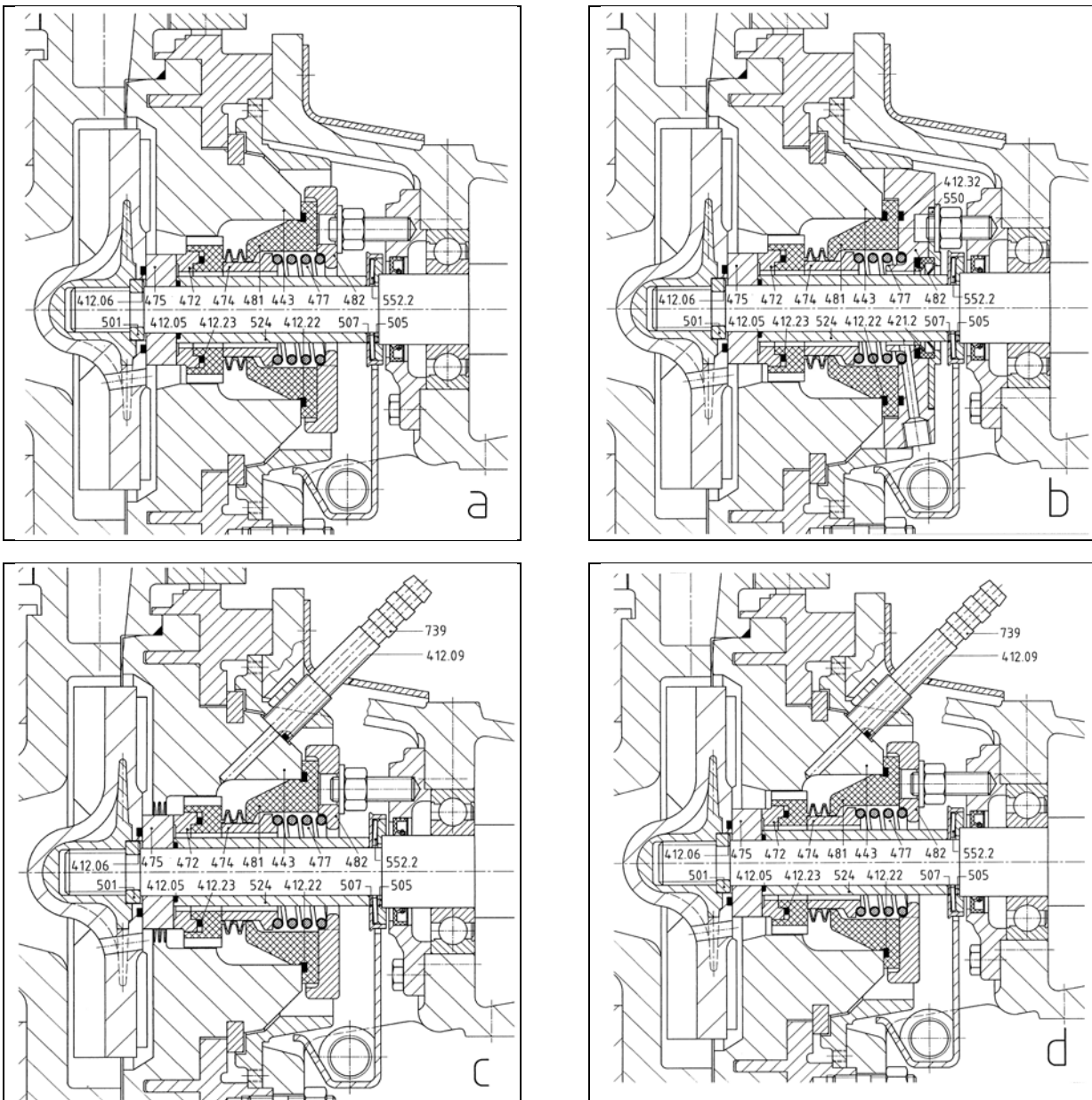

Part No.	Description	Part No.	Description
412.05	O-Ring	477	Spring for mechanical seal
412.06	O-Ring	481	Bellows
412.09	O-Ring	482	Bellows seat
412.22	O-Ring	501	Multiple ring
412.23	O-Ring	505	Loose collar
412.32	O-Ring	507	Thrower
421.2	Radial shaft seal	524	Shaft wearing sleeve
443	Seal insert	550	Thrower
472	Stationary seal ring	552.2	Spanner
474	Thrust ring	739	Hose coupling
475	Rotating seal ring		

Fig. 4.3 Representation of single WERNERT-PTFE-bellows-mechanical seal

- a) with interior rinsing (product rinsing) of mechanical seal (API Plan 01)
- b) with interior rinsing (product rinsing) and quench (API Plan 62)
- c) with rinsing connection and labyrinth seal (continuous rinsing) (API Plan 32)
- d) with rinsing connection without labyrinth seal for rinsing after use (stationary rinsing)

4.5.3 Back-to-back-mechanical seal as defined by DIN EN 12756

Back-to-back mechanical seals as defined by DIN EN 12756 (Fig. 4.4) are usually used for liquid to be pumped which have virtually no or only a small amount of solid material in them,

- which endanger health, water or the environment
- which would vaporise at a very small increase in temperature or if the pressure is decreased
- which tend to crystallisation.

Each one single mechanical seal is installed back-to-back on the product side and atmospheric side. The so-called sealing chamber is situated between the two pairs of mechanical seals. Usually the seal rings on the product side are secured against inadmissible axial and radial movement.

For further information about double acting mechanical seals please refer to ⇨ section 4.5.5.

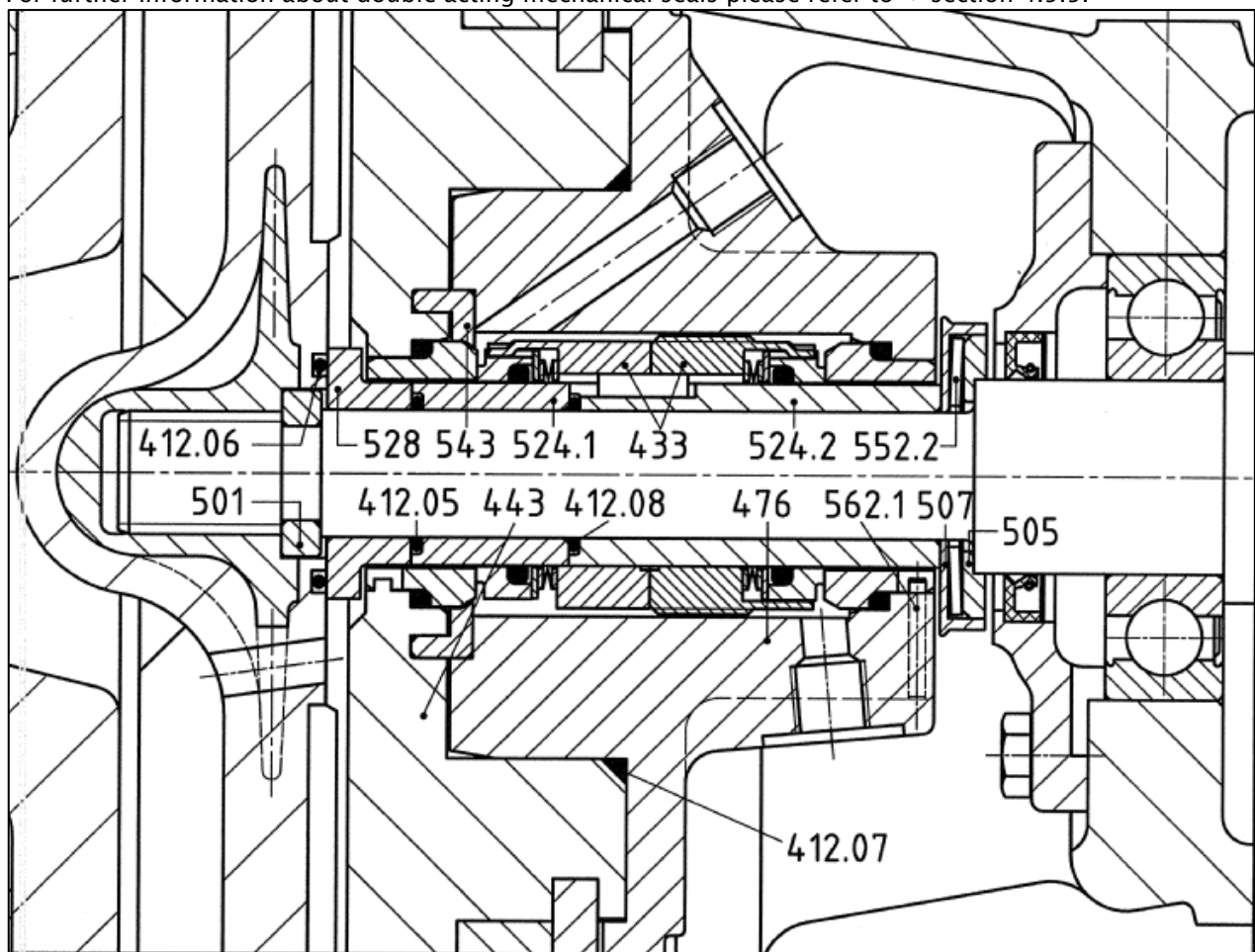

Part No.	Description	Part No.	Description
412.05	O-Ring	505	Loose collar
412.06	O-Ring	507	Thrower
412.07	O-Ring	524.1	Shaft wearing sleeve
412.08	O-Ring	524.2	Shaft wearing sleeve
433	Mechanical seal	528	Locating collar
443	Seal insert	543	Spacer bush
476	Stationary seal holder	552.2	Spanner
501	Multiple ring	562.1	Parallel pin

Fig 4.4 Diagram of a back-to-back-mechanical seal as defined by DIN EN 12756 with pumping screw suitable for API Plan 53A and 54.

4.5.4 Stationary double acting mechanical seal

Stationary double acting mechanical seals are usually used for "problematical" liquid to be pumped,

- which have a medium to high solid content
- which contain a high proportion of gas or air
- which endanger health, water or the environment
- which would vaporise if the temperature increased only slightly or if the pressure was reduced
- which tend toward crystallisation.

This type of mechanical seal (frequently also referred to as REA design) supports, by means of centrifugal forces, the movement of the sealing liquid from the sealing chamber into the shaft sealing space which in turn is very large and easy to rinse. This design avoids tight gaps and solids being deposited.

The following mechanical seal is used as standard:

EAGLEBURGMANN HRZ 13, shown in Fig. 4.5.

This type is also available as single-acting seal (HRZ 7) Fig. 4.6 or single-acting seal with quench.

For further information about double acting mechanical seals please refer to ⇒ section 4.5.5.

4.5.5 General information about double acting mechanical seal

Double acting mechanical seals must always be impinged with a suitable sealing fluid which is suited to be mixed with the liquid to be pumped. The sealing liquid can also – if the currently valid regulations permit this – be the cleaned fluid which might have to be cooled, but which can only be used if the metal elements within the sealing chamber do not corrode. The sealing liquid must continuously circulate between the two mechanical seals and is removed via an outlet on the opposite side. The sealing fluid must have a pressure of 1 to 1.5 bar above the pressure on the shaft sealing space. However, it must not exceed the pressure limit of the seal on the atmospheric side.

The maximum pressure in the shaft sealing space, which is immediately behind the impeller, is approx. 25% of the maximum differential pressure which can be achieved in the pump (with decreasing pumping flow) plus the supply pressure (pressure at the pump suction nozzle). If the pump is not working, it must be ensured that the pressure of the sealing liquid is higher than the interior pressure of the pump so that no liquid to be pumped reaches the sealing chamber.

If the sealing chamber is equipped with its own sealing aggregate with limited sealing liquid volume (API 682, Plan 53A), the sealing liquid must be forcibly cooled and circulated. In this case the circulation of the sealing liquid flow is supported by a pumping thread in the mechanical seal. Observe notes on the hose connection (⇒ section 5.4) of the additional connections.

If the sealing chamber is supplied with sealing liquid with the appropriate excess pressure and if the sealing liquid can flow freely from the sealing chamber, the liquid flowing off must be throttled in order to maintain the excess pressure in the sealing chamber. The supply line and the sealing chamber must be vented before commissioning.

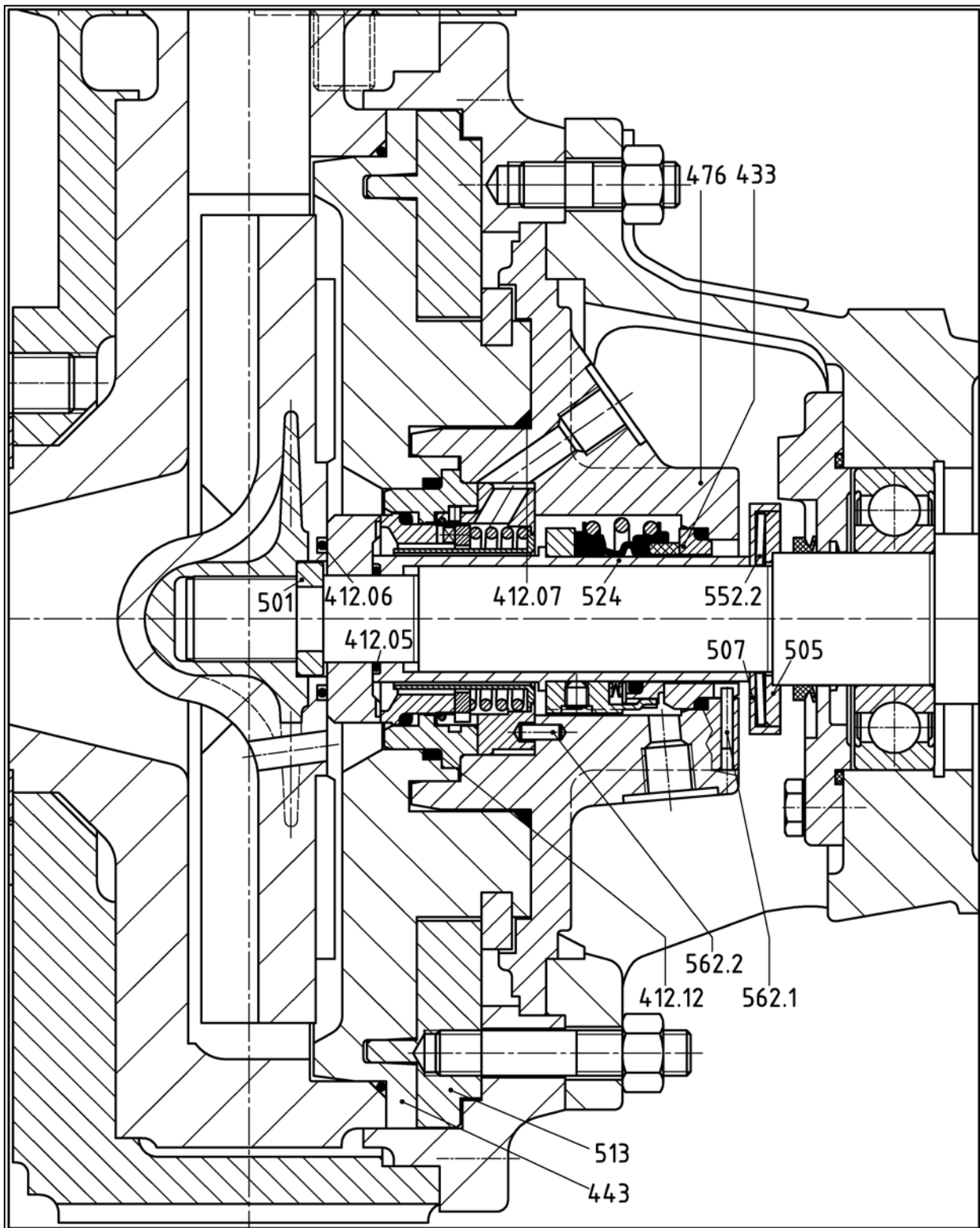

Part No.	Description	Part No.	Description
412.05	O-Ring	501	Multiple ring
412.06	O-Ring	505	Loose collar
412.07	O-Ring	507	Thrower
412.12	O-Ring	524	Shaft wearing sleeve
433	Mechanical seal	552.2	Spanner
443	Seal insert	562.1	Parallel pin
476	Stationary seal holder		

Fig 4.5 EAGLEBURGMANN HRZ 13 (API Plan 54),
 (suitable for API Plan 54), lower half with pumping screw (suitable for API Plan 53A and 54)

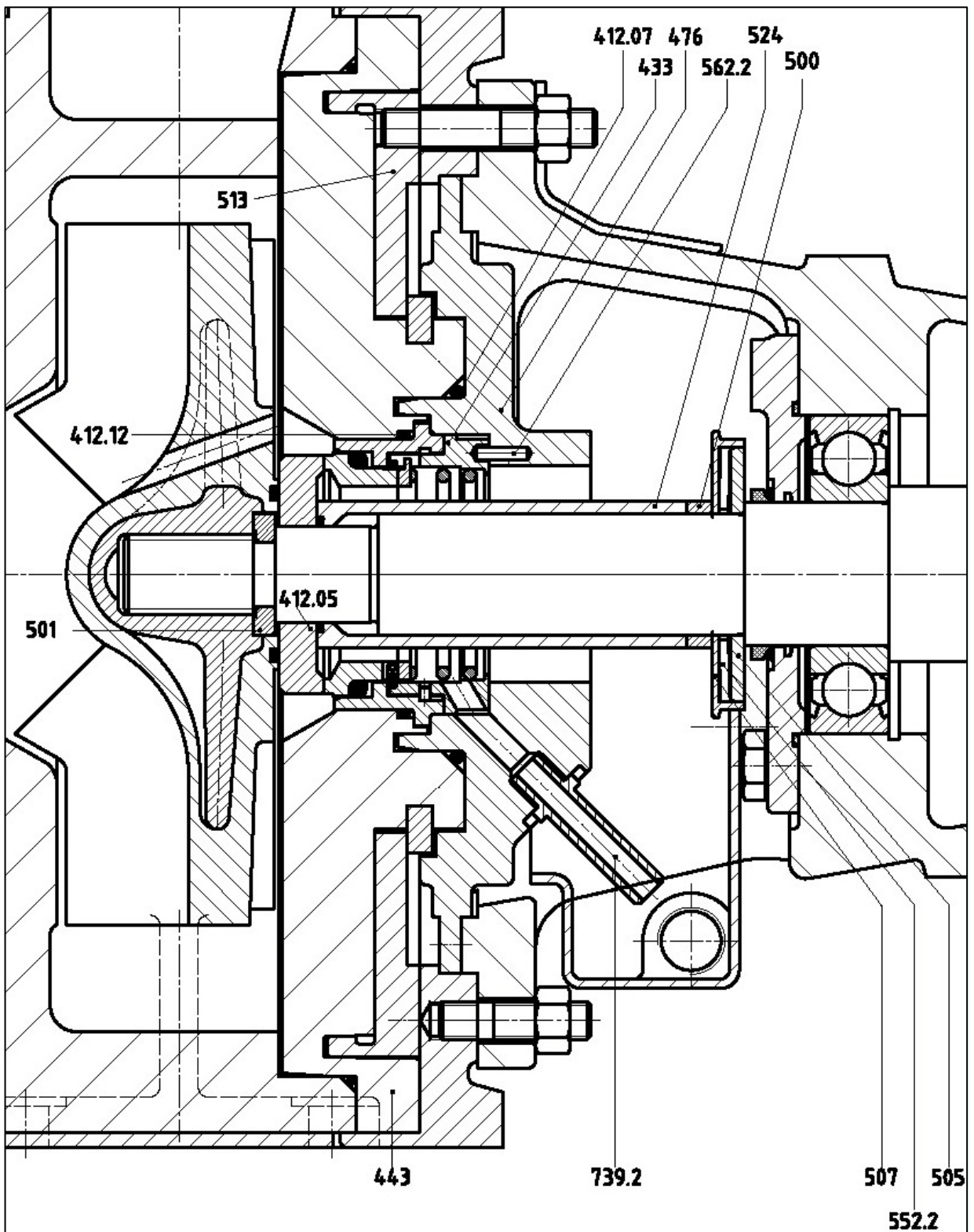

Part No.	Description	Part No.	Description
412.05	O-Ring	505	Loose collar
412.07	O-Ring	507	Thrower
412.12	O-Ring	513	Insert ring
433	Mechanical seal	524	Shaft wearing sleeve
443	Seal insert	552.2	Spanner
476	Stationary seal holder	562.2	Parallel pin
500	Ring	739.2	Hose coupling
501	Multiple ring		

Fig. 4.6 EAGLEBURGMANN HRZ 7

4.6 Special tools

The special tools described below are available from the manufacturer.

Type	Size	Bearing housing	Impeller key semi-open / 3D	Tool V-ring ⇒ Abb. 7.43, 7.45	Tensioning tool for multiple ring	Assembly tool for tensioning the bellows
NE_O	40-25-160	0	051F30469NAG019	-	-	-
NE_O	50-32-160 50-32-200 65-40-200 80-50-200	I	051B30650NAG019	Impeller side: 054E31092PPP019 Coupling side: 054L31092PPP029	052H30874PEL019	054D31067SKH039
NE_O	50-32-250 65-40-250 80-50-250 80-50-315 100-65-250 125-80-250	II	051K26944NAG019	Impeller side: 054F31092PPP039 Coupling side: 054A31092PPP049	052C30874PEL029	-
NE_O	125-80-200 125-100-200		051I26946NAG019			
NE_E	80-50-315 100-65-315		051D31340STA019			
NE_O	125-80-315 125-100-250 125-100-315 150-125-315	III	051D30315NAG019	Impeller side: 054E31092PPP059 Coupling side: 054L31092PPP069	052I30874PEL039	054D31067SKH039
NE_D	150-125-315		051B31220STA029			
NE_O	200-150-250		051I30976STA019			
NE_D	200-150-250		051G31220STA019			
NE_O NE_S	200-150-400 250-200-400	IV	054K31067SCA019 Pulling device	Standard version: On request. Long design: Impeller side: 054I31092PPP099 Coupling side: 054G31092PPP109	-	-

Fig. 4.7 List of special tools with manufacturer identification numbers

4.6.1 Impeller key (part 051)

Only for bearing housing sizes 0 – III:

To disassemble and assemble semi-open impellers with screw attachment onto the drive shaft it is wise to use a so-called impeller key (Fig. 4.8). The inside of this key is shaped to be a negative of the impeller blades.

- ✓ Secure the shaft against rotation.
- Place the key on the front of the impeller.
- Remove the impeller from the shaft in the direction of pump rotation.

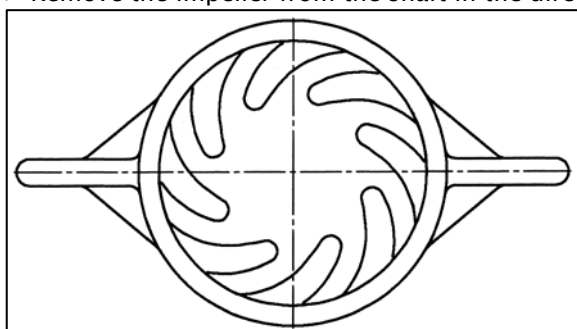

Fig. 4.8 Impeller key (part 051)

4.6.2 Tensioning tools (part 052)

Only for bearing support sizes I – III:

In order to be able to place the multiple ring (Part 501) with zero force behind the threaded stem of the shaft (part 210), the stationary seal ring (part 475) and the shaft wearing sleeve must (part 524) be displaced in the direction of the coupling against the force of the tension disc system (parts 505, 507, 552.2). This is done by using a tensioning tool as shown in Fig. 4.9.

- Screw the tensioning tool (part 052) onto the shaft end.
- Slide the rotating seal ring (part 475) to the bearing by evenly screwing the clamping screws.
- Insert and hold the multiple ring (part 501).
- Loosen the preload evenly and unscrew the clamping tool from the shaft end again.

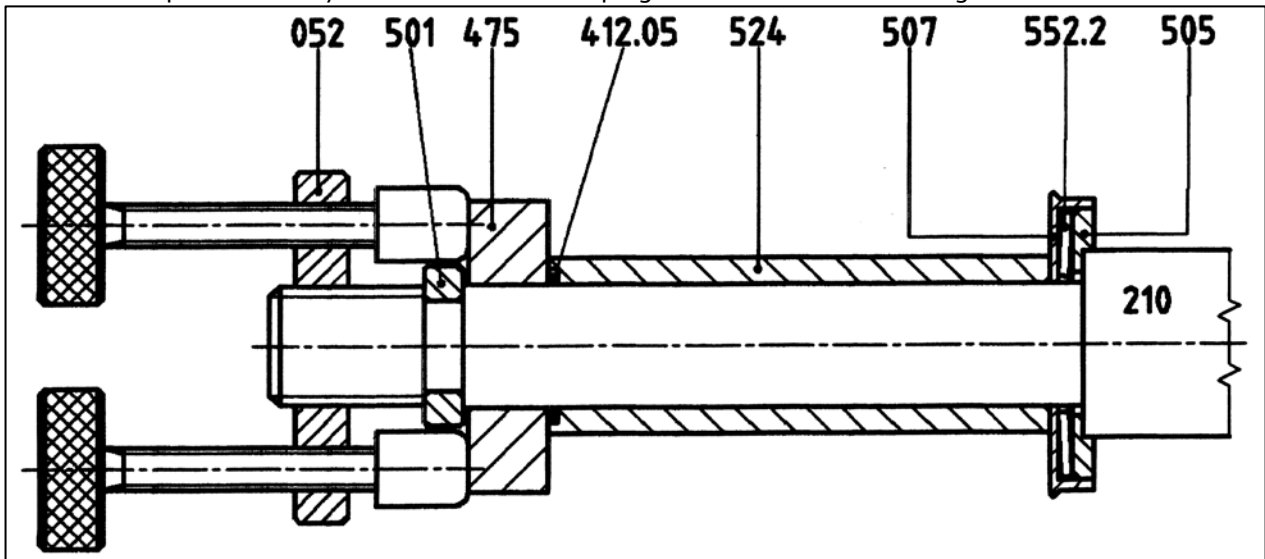

Fig. 4.9 Assembly of the multiple ring

4.6.3 Pulling device for left-hand impeller size IV



Fig. 4.10 Pulling device, WERNERT identification number: 054K31067SCA019

Description of disassembly left-hand impeller size IV

- Remove the hexagon nuts from the adaptor (part 902.06) and pull out the back pull-out unit.
- Securely fasten the back pull-out unit to the assembly table.

Tool	Denomination	Tool	Denomination
1	Wedge	8	Strap spanner
2, 3, 4, 5	Open-end wrench width 10, 19, 24, 41	9	Pneumatic screwdriver
6	Flat steel for fixing the shaft	054	Pulling device
7	Sandpaper		



Fig. 4.11 Tools for dismantling the impeller size IV

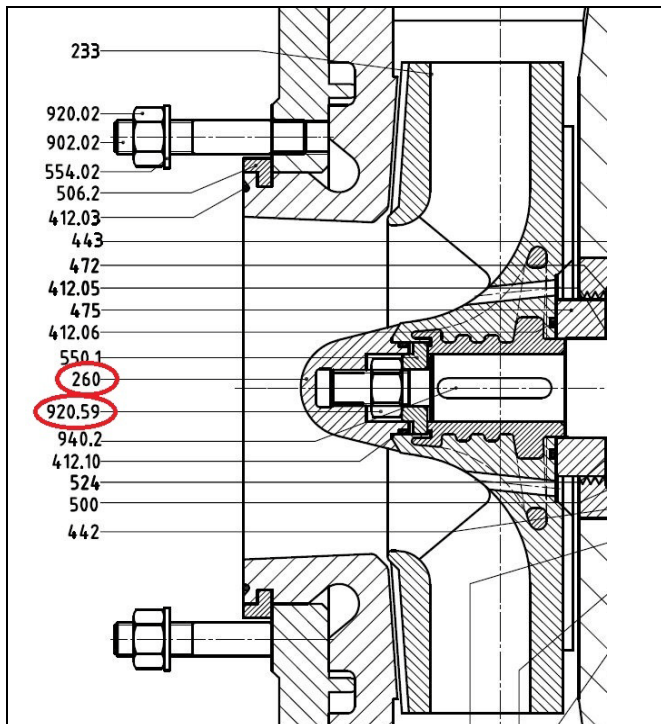

Fig. 4.12 Sectional drawing size IV



Fig. 4.13 ➤ Fix the shaft to the shaft journal or coupling to prevent twisting (tool 6).



Fig. 4.14 ➤ Unscrew the impeller cap (part 260) to the left using a strap spanner and sandpaper for better adhesion. Insert the wedge behind the impeller.



Fig. 4.15 ➤ Unscrew the hexagon nut (part 920.59) to the left.



Fig. 4.16 ➤ Screw 2 M6 hexagon head screws into disc (part 550.1) and remove the disc.



Fig. 4.17 Impeller with 4 threaded holes M6 in impeller bush.



Fig. 4.18 If the impeller bush is stuck on the shaft journal due to corrosion, for example, please use the pulling device.
 ➤ Fix the pulling device to the impeller bush by using 4 hexagon head screws (M6).
 ➤ Remove the impeller by screwing in the spindle.



Fig. 4.19 Normally the impeller can be pulled off the shaft end by hand.

4.7 Noise emission values

Airborne noise emissions by the pump or an aggregate are determined in accordance with DIN EN ISO 20361:2015.

The following applies for the specified pump sizes within the permissible operating range:

The A-weighted emitted sound pressure level $L_{pA} \leq 70$ dB(A) at a distance of one metre (1 m) from the reference cube.

Size	Speed up to 1450 rpm	Speed up to 2900 rpm
Bearing housing size 0	X	X
Bearing housing size 1	X	X without 80-50-200
Bearing housing size 2 without 125-80-250 und 125-100-200	X	

Fig. 4.20 Pump sound pressure level

The sound pressure level for all other pump sizes is listed in the following table.

Sound pressure level L_{pA} in dB(A)								
Coupling power in kW	Pump only $L_{pA(P)}$ at speed				Motor alleine $L_{pA(M)}$ bei Drehzahl			
	2900 rpm	1450 rpm	960 rpm		Nominal power in kW	2900 rpm	1450 rpm	960 rpm
1,5	55,0	53,0	51,0		1,5		49	49
2,2	56,5	54,5	52,5		2,2	60	53	52
3,0	59,0	57,0	55,0		3,0	62	53	54
4,0	60,5	58,0	55,5		4,0	63	53	54
5,5	62,5	60,0	57,5		5,5	68	58	56
7,5	65,5	63,0	60,0		7,5	68	62	56
11,0	68,0	65,0	62,0		11,0	70	66	61
15,0	70,5	67,5	64,5		15,0	70	66	61
18,5	73,0	69,5	66,0		18,5	70	63	62
22,0	74,5	70,5	67,0		22,0	70	65	62
30,0	76,5	72,5	68,5		30,0	71	65	63
37,0	77,5	73,5	69,5		37,0	73	60	63
45,0	78,0	74,0	70,0		45,0	74	62	65
55,0	79,0	75,0	71,0		55,0	75	65	65
75,0	80,0	76,0	72,0		75,0	73	67	68
90,0	80,5	76,5	72,5		90,0	74	70	68
110,0	81,0	77,0	73,0		110,0	78	72	68
132,0	82,0	78,0	74,0		132,0	78	72	68
160,0	82,5	78,5	74,5		160,0	82	73	68
200,0	83,5	79,5	75,5		200,0	82	76	68
250,0	84,0	80,0	76,0		250,0	82	75	68

Fig. 4.21 Sound pressure level for pump resp. Motor

The total emitted sound pressure level of an aggregate is calculated as follows:

$$L_{pA_{ges}} = 10 \cdot \log \left(10^{\frac{L_{pA(P)}}{10}} + 10^{\frac{L_{pA(M)}}{10}} \right)$$

The values stated here apply for operation with cold water in the permissible range. Different noise emission values may be obtained in other operating modes or with other pumped media, especially when

pumping media containing solids. If the values stated in order-related documents differ from those indicated here, the order-related documents shall prevail.

The emitted sound pressure level of the motor may differ from that stated here, depending on model and make. The sound pressure level of motors increases by +4 dB in 60 Hz operation.

4.8 Accessories

The scope of delivery is described in the order confirmation and may include, for example, the following parts in addition to the pump:

- Coupling: Flexible coupling with or without intermediate coupling sleeve
- Protection against accidental contact for coupling
- Motor
- Base plate of torsion-resistant design of grey cast iron
- Foundation fastening and/or installation: Levelling elements, stone bolts, shear connectors
- Special accessories, according to order

4.9 Dimensions and weights

Dimensions and weights are documented as follows:

	Dimension drawing	Arrangement drawing	Pump nameplate, ⇨ capter 13	Baseplate, transport packing	Motor nameplate
Dimensions	X	X			
Weight of pump		X	X		
Weights components		X			X
Total weight		X		X	

Fig. 4.22 Dimensions and weights

5. Erection

5.1 General

 DANGER	<p>Improper installation</p> <p>Explosion hazard. Increased wear and damage to the pump unit.</p> <ul style="list-style-type: none"> ✓ Prepare the foundation according to the mass of the pump unit and the surface pressure. ✓ Align the base plate. ✓ Observe permissible nozzle forces and torques. ✓ The EC Council Directive 1999/92 on minimum regulations for the improvement of the health protection and safety of the employees who may be endangered by explosive atmospheres must be complied with. The EN 1127-1 Standard is to be observed (explosion protection). ✓ In hazardous areas, the operator must prevent objects from falling on the pump. ✓ Observe local explosion protection regulations. ✓ Observe the technical data of the pump unit.
---	--

Liability for installation errors and for the consequences of non-observance of safety instructions is excluded in the case of work not carried out by the manufacturer.

The pump must be installed horizontally. Vertical installation is only permitted if this is expressly described by the manufacturer in the order-related documents.

5.2 Installation of the pump mounted on the base plate

5.2.1 Alignment of the base plate

Before delivery, the pump is aligned with the base plate and fixed. If, due to rough transport, the position of the pump to the base plate has changed, then the original position must be attained again by referring to the dimensional drawings.

Furthermore, the pump is aligned to the plant merely by positioning the base plate.

When installing in the plant, the base plates must be aligned so that

- 1) the level of the discharge nozzle is horizontal in every direction. For example, this can be checked with a machine spirit level.
- 2) Suction and discharge pipelines must be connected with the pump nozzles in such a way that the admissible nozzle loads are not exceeded. The admissible nozzle loads are listed in (⇒ chapter 11).

The base plate is aligned according to the means of fixing selected for this aggregate. There are three ways of fixing possible:

1) Simple fixing to the foundations

The base plate is fixed to the foundations by means of stone bolts or shear connectors which have been anchored into the foundation beforehand and which project through the corresponding holes in the base plate.

➤ Before these are tightened, the base plate must be aligned using spacers and thin pieces of metal. The base plate is aligned in such a way that it is supported by three aligning spacers. Each spacer is positioned on the left and right longitudinal side in the area of the drive, the third spacer is positioned in the area of the pump on the short side. If the base plate is longer than 1600 mm, more spacers might be necessary. The exact height should be achieved using pieces of thin metal of different thicknesses.

➤ Fix the base plate to the stone bolts or composite anchors by tightening the nuts with washers.

2) Fixing on foundations with subsequent casting

The base plate is fixed to the foundations by means of stone bolts or shear connectors which have

been anchored into the foundation beforehand and which project through the corresponding holes in the base plate.

- Prior to casting, alignment must be carried out by means of supports and thin metal sheets (as described under 1).
- Tighten the foundation bolts evenly.
- Cast the base plate with shrinkage-free concrete in normal grain size with a water-cement value of ≤ 0.5 .



3) Erection on levelling elements without foundation

The pump aggregate is supported above the floor on oscillation absorbers.



- Align the base plate using the adjusting screws.

No foundation screws are necessary.

A pump of this type delivered on a base plate is basically suitable for all three types of mounting mentioned above.



 DANGER	<p>Danger due to electrical energy</p> <p>Explosion hazard. Potential differences due to insulated installation.</p> <ul style="list-style-type: none"> ✓ Avoid potential differences. ✓ Provide separate earthing by connecting to earthing lugs on motor and base plate.
	

5.2.2 Connecting the pipes

 CAUTION	<p>Use of flat gaskets and stud bolts with too long screw-in threads</p> <p>Leaks. Damage due to deformation of the pump housing. Abrade the impeller on the front face of the pump casing.</p> <ul style="list-style-type: none"> ✓ Use stud bolts with suitable thread lengths. Use original parts. ✓ Use a suitable length of stud bolts according to the required clamping length. ✓ Connect pipelines to the pump connections as free of stress as possible. Observe permissible nozzle loads (⇒ chapter 11). ✓ Do not seal the pump connections with flat gaskets but with the enclosed O-rings. Exception: WERNIT version, here the sealing is carried out with flat gaskets to be provided by the operator.
	

If subsidiary pipeline connections are intended, e.g. for sealing, rinsing or quench media, the necessary pipeline attachments and connections must be made.

5.2.3 Aligning the drive

 DANGER	<p>Motor not sufficiently aligned with pump</p> <p>Leaks. Vibrations. Impermissible temperatures. Increased wear on mechanical seal and rolling bearing.</p> <ul style="list-style-type: none"> ✓ Align the motor to the pump. ✓ Observe the operating instructions for the coupling. Observe permissible tolerances. ✓ After connecting the pipes to the pump, carry out alignment check. ✓ The alignment must also be carried out and checked for pump units if the pump unit has been delivered completely assembled on a base plate.
	

The position of the drive shaft relative to the pump shaft is measured via the coupling.

Intermediate sleeve couplings are generally used for this type series. Fig. 5.1 shows this type of coupling, the intermediate sleeve can be removed after loosening the connecting screws.

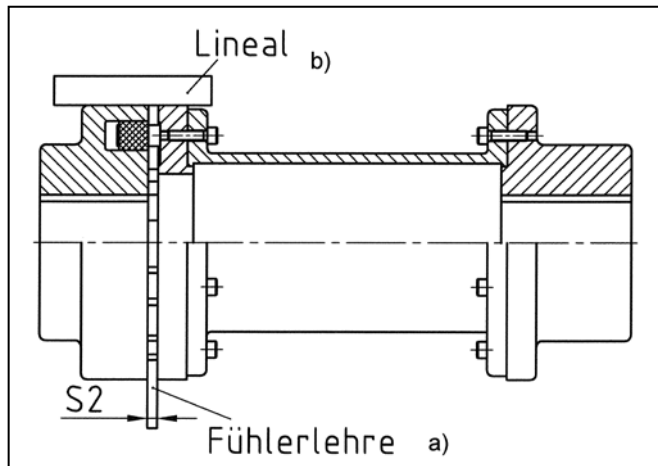

- ✓ Dismantle coupling guard.
- Align the motor to the pump.
- Observe permissible tolerances for axial misalignment, angular misalignment and radial misalignment according to the respective operating instructions of the coupling.

For Flender N-Eupex H and HDS applies:

Coupling size	Axial misalignment S_2 in mm
80 ... 140	5
160 ... 225	6
250 ... 400	8

Tolerance: +1 mm

Fig. 5.1 Intermediate sleeve coupling, measurement using feeler gauge (a) and straight-edge (b).

Depending on the coupling size, the required axial misalignment S_2 between the cam and package part of the coupling must be maintained evenly and within the permissible tolerance range. The axial misalignment can be determined using a feeler gauge.

- Ensure and check this distance by axial alignment of the drive.
- Align and check the angular and radial alignment of the drive. Three procedures are usual here, measurement with a straight-edge, measurement with a dial gauge and measurement with the help of a laser beam. All procedures give correct results.

The angle and height of the drive depends on the aggregate supplied and can be adjusted with the help of thin pieces of material or regulating screws.

- After aligning it, the drive must be fixed.
- Check alignment after fixing.
- After correct alignment, remount the coupling guard.

5.3 Pipes

5.3.1 General

The pipe diameter and the layout of the pipes have usually been determined during the planning stage. The recommendations for pipeline layout can only be basically considering that the final laying of the pipes will have to take the specific local situation into consideration, which the pump manufacturer is usually not aware of, into consideration.

5.3.2 Notes on laying pipes

⚠ DANGER	Exceeding the permissible forces and torques at the pump connections
	<p>Danger to life and the environment due to leaking fluid at leaking points. Deformation of the mechanical seal. Increased wear. Increased bearing load. Impermissible surface temperatures.</p> <ul style="list-style-type: none"> ✓ Observe permissible forces and torques at the pump connections (⇒ chapter 11). This applies both to standstill of the system and to operation. ✓ The pump must not serve as a fixed point within the piping system. ✓ Support the piping with brackets in such a way that it neither strains the pump nor causes it to vibrate during operation. ✓ Any expansions of the pipelines caused by temperature differences and process-conditioned impacts must be compensated for by taking suitable measures. The installation of compensators in front of the suction and discharge nozzles of the pump is recommended. For any increased flow resistances to be avoided, compensators should have the nominal diameter of the respective pipeline.

	<ul style="list-style-type: none"> ✓ Tightening connection screws on the pump flanges may not cause any twisting. ✓ Observe tightening torques (⇒ chapter 12). ✓ The alignment of the drive to the pump must be checked and, if necessary, corrected after connecting the pipes and before commissioning (⇒ chapter 5.2.3).
! WARNING	<p>Seals protrude into cross-section passage</p> <p>Increase of pipe drag. Leaks.</p> <ul style="list-style-type: none"> ✓ When laying and connecting the pipes, make sure that the seals do not protrude into the cross-section passage. ✓ Install pipelines in alignment, Figure 5.2.

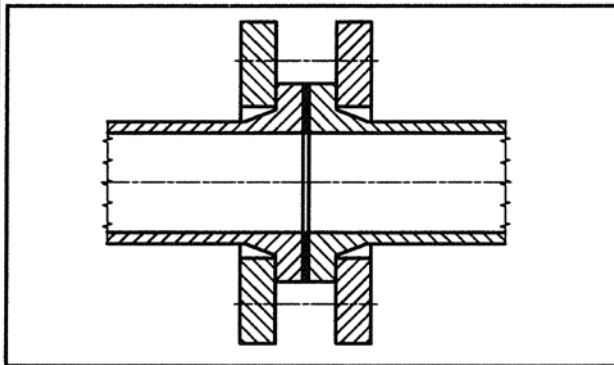

correct

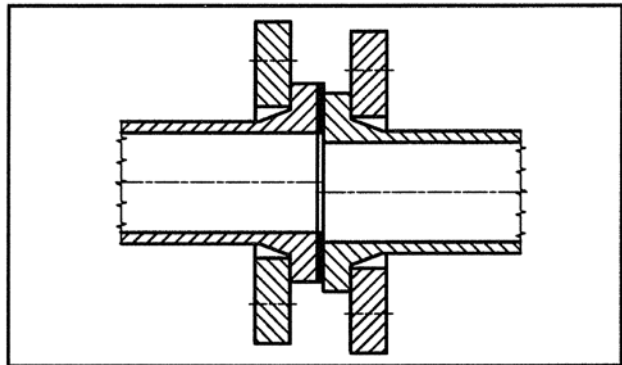

INCORRECT

Fig. 5.2 Connection of pipelines

5.3.3 Suction pipe

- ✓ The suction pipe should be as short as possible and its diameter should never be smaller than that of the suction nozzle. If the suction pipe is larger, an eccentric transition with synchronous upper edge must be used, which prevents the formation of air sacks.

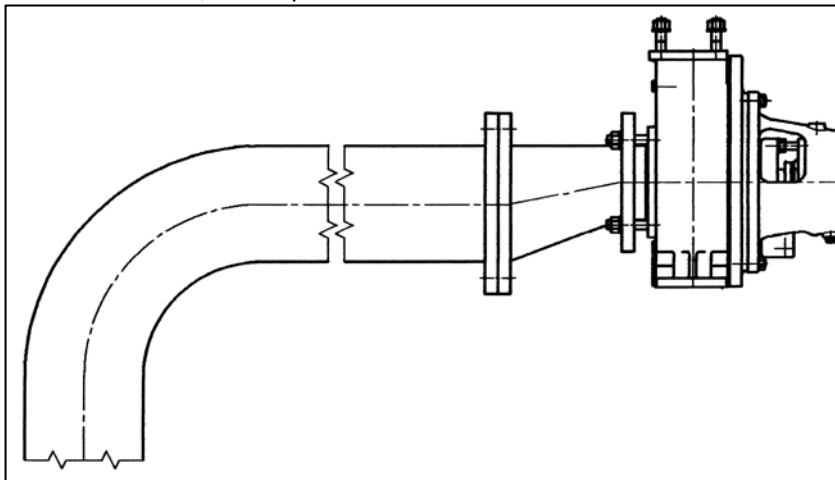



Fig. 5.3 Transition between suction pipe and pump suction nozzle









- ✓ Select the cross-section of the suction line so that a flow velocity of 2 m/s of water or liquids of the same viscosity, is not exceeded.
- ✓ Grater pressure losses due to excessive pipe lengths or installations must be avoided.
- ✓ The pipe must be completely leak-proof (pressure test) and must not contain any air sacks.
- ✓ Horizontal pieces of pipes should have an ascending gradient of at least 1% in the direction of the pump.
- ✓ Sharp corners and bends must be avoided in the pipes, as a rising then falling suction line.

	<p>Notice</p> <p>In the case of self-priming pumps, the suction pipe is easier to evacuate if the pump is switched on when the highest possible level of liquid is in the pump sump.</p>
--	--

	<p>Notice</p> <p>Gassing liquids should not be pumped in suction operation. If in doubt, ask the manufacturer.</p>
---	--

5.3.4 Self-priming by means of liquid reservoir (priming tank)

By attaching a liquid reservoir system (priming tank) to the pump suction nozzle, a normal centrifugal pump can evacuate the suction pipe.

	<p>DANGER</p> <p>Leaks on suction side or inadmissible pipe resistances</p>
	<p>Pump is not pumping or is interrupted. Danger of dry-run. Danger of explosion.</p> <ul style="list-style-type: none"> ✓ Use suitable seals. ✓ Check the suction line for leaks. ✓ Minimize pipe drag. Adhere to the permissible pipe cross-section and lengths.
	<p>Notice</p> <p>The useful volume of the priming tank (between bottom edge of supply nozzle and top edge of outlet nozzle) must be at least 50 % larger than the volume of the suction pipe. Standard priming tanks are allocated to the pump models for the following suction ratios:</p> <ul style="list-style-type: none"> - Nominal width of suction pipe according to nominal width of the suction nozzle - Maximum geodetic suction height 3 m - Horizontal length of suction line ≤ 0.2 m (inlet side of priming tank) - Density of the aqueous medium approx. 1.05 kg/l. <p>If the volume of the suction line, the density of the pumped medium and/or the geodetic suction head is greater than specified above, the priming tank must be adapted to the suction conditions.</p>
	<p>DANGER</p> <p>Explosive mixture in the priming tank</p>
	<p>Explosion hazard.</p> <ul style="list-style-type: none"> ✓ When using an priming tank with flammable pumped media, the operator must ensure that neither the pump nor the priming tank can produce an explosive mixture.
	<p>ATTENTION</p> <p>Risk of machine damage</p>
	<p>Destruction of the tank due to overpressure</p> <ul style="list-style-type: none"> ✓ Observe maximum permissible pressure of 0.5 bar(g).
	<p>Notice</p> <p>Priming tanks supplied by WERNERT-PUMPEN usually are only suitable up to an overpressure load of 0.5 bar(g). They are not pressure vessels and are therefore not subject to the 2014/68/EU Pressure Equipment Directive. The operator must ensure that the internal pressure in the system is below the value specified here.</p>
	<p>Notice</p> <p>When sucking via the priming tank, the pump should be equipped with a reflux valve (\Rightarrow section 5.3.7) on the discharge side in order to avoid the pump and tank emptying by siphon effect once the pump has been switched off.</p>
	<p>Notice</p> <p>Prior to initial start-up or after draining, the attachment tank must be filled up with liquid at the filling opening. Thereafter, the filling opening must be closed, gas-tight. In addition, it must be assured that the suction line is sufficiently vacuum-resistant.</p>

- ✓ Pipes which are to be connected to the attached priming tank must be secured without tension.
- ✓ Support pipelines with brackets. No forces or moments must be transferred from the pipelines to the vessel or the connection pieces.
- ✓ The attached priming tank must be connected as close to the pump as possible.
- ✓ Fasten the pump and priming tank on a common base plate if possible. If the attached priming tank is not placed on the base plate, care must be taken to ensure that the bottom of the attached priming tank rests fully on a level surface and is properly secured.

5.3.5 Supply line

- ✓ Lay the supply line continuously downwards to the pump suction nozzle. It should never be smaller than the suction nozzle of the pump.
- ✓ The cross section of the supply line must be selected so that a flow speed of 2.5 m/s of water or liquids of the same viscosity is not exceeded.

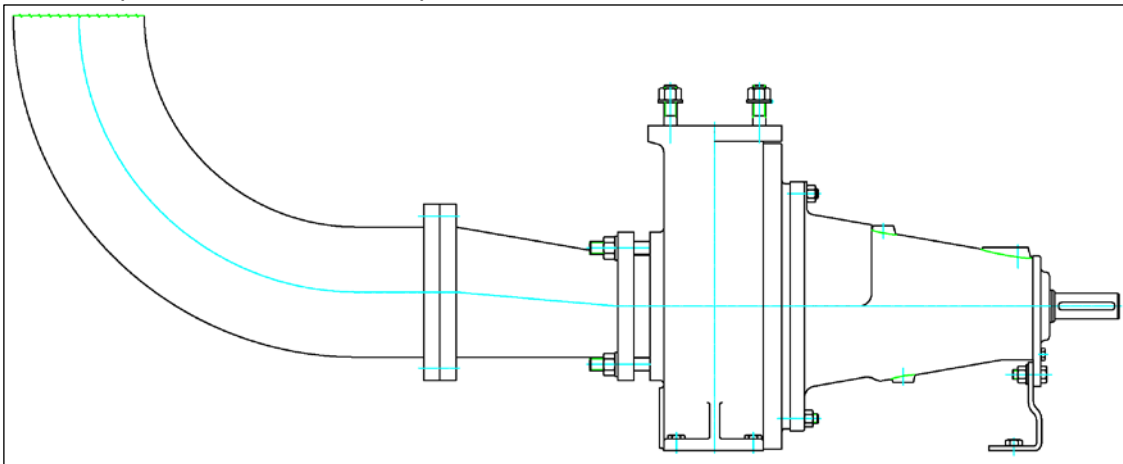

Figure 5.3 Supply line

	<p>Notice</p> <p>For repair purposes, the installation of a shut-off valve at a sufficient distance to the suction branch (approx. 2 to 3 times the pipeline diameter) is recommended which must be completely opened during the operation of the pump. The shut-off devices in the supply and/or suction line are to be arranged so that according to the valve design, no air pockets may be formed.</p>
	<p>Notice</p> <p>To avoid increased flow resistances, any additional instruments which must be installed should have the nominal diameter of the supply line. Sharp edges and bends are to be avoided.</p>

5.3.6 Discharge line, throttling bush

- ✓ The discharge line should not be smaller than the discharge nozzle of the pump.
- ✓ In order to reduce wear, a flow velocity of ≤ 5 m/s in the pressure line should be maintained as far as possible in the case of pumped media containing solids.
- ✓ A shut-off and/or control instrument is to be installed as close as possible to the pump.

Pumps whose type designation bears the supplementary letter "D" (e.g. NEPO 80-50-315 D) are delivered with a throttling bush for location on the discharge nozzle. The throttling bush is delivered loose together with the required O-rings for location on suction and discharge nozzle.

- ✓ The throttling bush has to be positioned strictly centric onto the pumps discharge nozzle and is fixed between pump and discharge line.





DANGER	<p>Throttling bush is not installed</p> <p>Explosion hazard due to inadmissible temperature due to overheating of the motor. Damage to the motor due to excessive coupling power. Impermissible operating point.</p> <ul style="list-style-type: none"> ✓ A pump that has been designed with a throttling bush must be operated with this.

5.3.7 Check valve



	<p>Notice</p> <p>A check valve must be positioned so far above the discharge nozzle of the pump that the pump is safely filled with the pumped medium at start-up, even if an air cushion forms upstream of the check valve.</p>
ATTENTION	<p>Risk of machine damage</p> <p>Risk of dry running due to insufficient ventilation.</p> <ul style="list-style-type: none"> ✓ Mount the check valve at a suitable distance above the discharge branch. ✓ If possible, provide ventilation below the reflux valve.

5.4 Additional connections



- ✓ For the dimensions and position of the additional connections required for the pump (sealing liquid, flushing liquid etc.), please refer to the installation plan.
- ✓ The piping or hose connection for the sealing liquid for a double-acting mechanical seal or for a Quench tank must be laid continuously rising from the connection for the mechanical seal to the tank. In order to ensure proper ventilation, no air sacs may form.
- ✓ The assembly of this connection must be carried out without tension. The hose length must be suitably adapted or the height of the thermosyphon system must be adapted.

 DANGER	<p>Dry running of the mechanical seal</p> <p>Explosion hazard. Damage to the pump.</p> <ul style="list-style-type: none"> ✓ These connections are decisive for the function and must therefore be properly attached. The required volume flows and pressures are to be set (⇒ section 7.3).
 	
 WARNING	<p>Not connected or incorrectly connected additional connections</p> <p>Risk of injury from leaking fluid.</p> <ul style="list-style-type: none"> ✓ Connecting pipes and fittings must be suitable for the respective pressures.
	<p>Notice</p> <p>Quench: Avoid blockage of the flow limiter.</p> <p>Flush the supply line before connecting it to the quench connection and check the cleanliness of the flushing liquid.</p>

5.5 Touching protection for coupling

 WARNING	<p>Freely accessible rotating coupling</p> <p>Risk of injury from rotating parts.</p> <ul style="list-style-type: none"> ✓ Mount a suitable touching protection on the base plate before commissioning. ✓ A damaged touching protection must be replaced.
 DANGER	<p>Unsuitable or non-existent touching protection for coupling</p> <p>Explosion hazard due to inadmissible temperatures due to friction, impact or sparks.</p> <ul style="list-style-type: none"> ✓ The touching protection must be made of a suitable material with sufficient strength and must be chemically resistant in accordance with the ambient conditions. ✓ The touching protection must permanently have a suitable distance from the rotating parts, both the coupling and the shaft ends. <p>A touching protection supplied by the manufacturer fulfils these criterias for the corresponding pump unit. If the pump unit is modified, the suitability of the touching protection must be checked and, if necessary, replaced with a suitable touching protection.</p>
	









5.6 Final inspection

 WARNING	<p>Unauthorized starting of the motor</p> <p>Personal injury by touching rotating parts or flying out coupling parts.</p> <p>Impermissible surface temperatures. Sparking due to friction! Explosion hazard.</p> <ul style="list-style-type: none"> ✓ Before working on the coupling, the motor must be safely disconnected from the mains supply. ✓ Prevent inadmissible switching on of the motor. ✓ Observe the operating instructions of the motor.
 	

- ✓ The motor is reliably disconnected from the mains.
1. Remove the touching protection for the coupling.
 2. Check the alignment according to ⇒ chapter 5.2.3 as well as the correct distance between coupling and touching protection.
 3. Check function of coupling, mechanical seal, bearings and connections. It must be possible to turn the shaft manually on the coupling.

4. Mount touching protection for coupling.

5.7 Electric connection

 DANGER	<p>Work on the electrical connection by unqualified personnel</p> <p>Risk of death due to electric shock.</p> <ul style="list-style-type: none"> ✓ The electrical connection may only be carried out by a qualified electrician. ✓ Observe the regulations for electrical installation.
<ul style="list-style-type: none"> ✓ Observe the operating instructions for the motor. ✓ Compare the available mains voltage, current and frequency with the information on the motor nameplate. ✓ Use a suitable type of electrical wiring. ✓ Check the direction of rotation according to ⇨ section 6.1.3. 	
 DANGER 	<p>Improper electrical installation</p> <p>Explosion hazard due to inadmissible temperatures or sparks.</p> <ul style="list-style-type: none"> ✓ DIN EN 60079-14 must be observed in hazardous areas. ✓ Always use a motor protection device for explosion-protected motors.
 WARNING 	<p>Faulty electrical connection</p> <p>Damage to the motor and wiring. Overheating.</p> <ul style="list-style-type: none"> ✓ Connect the motor properly. ✓ Observe local regulations.
	<p>Notice</p> <p>It is recommended to use a suitable motor protection device.</p>
 DANGER 	<p>Static charge</p> <p>Explosion hazard. Damage to the pump unit.</p> <ul style="list-style-type: none"> ✓ Make electrical equipotential bonding by connecting the grounding connections to the motor and base plate.
	<p>Notice</p> <p>In the case of operation deviating from the operating mode of the motor, the motor winding can be heated to an inadmissibly high temperature.</p> <ul style="list-style-type: none"> ✓ Observe the permissible duty cycle according to the operating mode of the motor.

6. Starting up / Operation / Shutting down

6.1 Measures prior to commissioning

6.1.1 Cleaning and hydraulic pressure test of pipes

Before starting the pump up for the first time, all foreign bodies which might be left in the pipes from the installation of the pump, must be removed (screws, forging scales, welding drops etc.). Then the pipes are checked for leaks. Suction and discharge pipes must be hydraulically tested in accordance with the respective safety instructions.

Before starting up the pump again after repairs have been made to the pump, all broken parts of any kind – especially duroplastic or ceramic parts – must be removed from the pipelines. These broken parts can be created when the mechanical seal is broken or if components made of Wernit® break suddenly due to overload or the action of foreign bodies.

 ATTENTION	Foreign bodies or fragments in the piping system Damage to the pump or other parts of the plant. ✓ Clean the pipelines.
--	--

6.1.2 Ensure bearing lubrication

a) Bearings can be relubricated with grease



Grease-lubricated bearings are filled with a suitable grease at the factory.

 ATTENTION	Heating of the bearing housing Premature wear. ✓ Do not relubricate grease-lubricated rolling bearings before initial operation.
--	---

b) Lifetime lubricated bearings

Bearings lubricated for life are sealed with frictionless covers. Re-lubrication is not possible.

c) Oil-lubricated bearings

 WARNING 	Non- or insufficiently lubricated rolling bearings Damage to the rolling bearings. Impermissible surface temperatures. Sparking due to friction. Explosion hazard. Leaking oil. ✓ Before starting up the system, the bearing housing must be filled with oil! Filling with oil is effected as described in ⇒ section 7.2.2. ✓ Keep fill level.
---	---



6.1.3 Checking the direction of rotation

 WARNING	<p>Unauthorized starting of the motor</p> <p>Personal injury by touching rotating parts or flying out coupling parts. Impermissible surface temperatures. Sparking due to friction! Explosion hazard.</p> <ul style="list-style-type: none"> ✓ Before working on the coupling, the motor must be safely disconnected from the mains supply. ✓ Prevent inadmissible switching on of the motor. ✓ Observe the operating instructions of the motor.
--	---

Pump aggregates with intermediate sleeves are supplied in an uncoupled state. To do this, the cam plate of the coupling is unscrewed, but still projects into the packet part of the coupling. The screws are on the inside of the intermediate sleeve ⇒ Fig. 7.6.

✓ Remove intermediate sleeve.

Pump aggregates without intermediate sleeves are – if possible – also supplied in an uncoupled state.



 ATTENTION	<p>Wrong direction of rotation</p> <p>The impeller detaches from the shaft! Damage to the impeller, pump casing and bearings.</p> <ul style="list-style-type: none"> ✓ Only check the direction of rotation of the motor in the uncoupled state. ✓ Observe the direction of rotation arrow on the bearing housing (part 350) of the pump. ✓ Set the direction of rotation of the motor according to the direction of rotation of the pump.
	<p>Notice</p> <p>Even if the pump runs in the wrong direction for only a short time, it can be damaged!</p> <ul style="list-style-type: none"> ✓ Make sure that the pump can only be driven in the correct direction of rotation.

6.1.4 Tightening the WERNERT–bellows

The serial shaft seal is a patented WERNERT bellows–type mechanical seal with the bellows made of elastomer (EPDM or FPM) or PTFE. When using an elastomer bellows, the bellows seat (Part 482) acc. to Figure 7.59 is to be tightened only to such a degree that the space between bellows and neck of the sealing insert is sealed.

Tightening torque: approx. 7.5 Nm.

The WERNERT PTFE bellows is pretensioned with a tightening torque of approx. 15 Nm before delivery and must not be retensioned before starting. Check that the PTFE bellows is pretensioned before starting. By means of screws, the hoods removed (Part 683) are to be fixed again to the bearing housing.

 WARNING	<p>Rubbing on non-conductive surfaces</p> <p>Explosion hazard due to static discharge.</p> <ul style="list-style-type: none"> ✓ During cleaning or mounting the hoods or when mounting the drip plate (part 463), see to it that there is no electrostatic discharge. A non-conducting material may be charged by friction. This must be avoided.
	<p>Notice</p> <p>If leaks occur due to advanced wear of the seal rings, the bellows seat should not be tightened. If a different shaft seal design has been intended, tightening is not possible anyway.</p> <ul style="list-style-type: none"> ✓ Replace worn parts.
	<p>Notice</p> <p>ONLY FOR WERNERT-ELASTOMERE-BELLOWS:</p> <p>The pump is supplied with a relaxed elastomere bellows so that the pre-tension due to longer periods of storage are not decreased.</p> <ul style="list-style-type: none"> ✓ For this reason the elastomere bellows must be pretensioned before starting up by tightening the bellows seat.

6.1.5 Safety devices for the protection of people

 WARNING	<p>Freely accessible rotating parts</p> <p>Risk of injury from rotating parts.</p> <ul style="list-style-type: none"> ✓ Before commissioning, mount a suitable touching protection for the coupling on the base plate ⇒ figure 7.3. ✓ Mount splash guard on bearing housing. ⇒ figure 7.62. If the pump is driven using belts, all respective safety devices must be fixed above the discs and the belts.
--	---

Electrical motors and other devices must be installed in accordance with the currently valid safety regulations (⇒ section 5.7).

6.2 Starting the pump

 ATTENTION	<p>Bonded sliding surfaces can damage the mechanical seal and the bellows during start-up.</p> <ul style="list-style-type: none"> ✓ Before the check: Prevent inadmissible switching on of the motor! ✓ Check that the shaft can be turned by hand. ✓ If necessary, relax bellows, flush mechanical seal, pretension bellows and check again that the shaft can be turned by hand. <p>This is especially important for pumps that have not been in operation for a long time.</p>
--	--

When starting up the pump, please follow the following procedures:

- 1) If a flushing or sealing liquid supply is provided, same must first be started with the required pressure and volume flow (⇒ section 7.3).

The operator must ensure the chemical compatibility of the flushing and sealing medium with the pumped medium and the parts of the pump that come into contact with the product.

The maximum permissible overpressure of the flushing or sealing liquid (p_{fl}) must be maintained in accordance with the design of the mechanical seal:

Single mechanical seal: $p_{fl} = \text{max. } 2 \text{ barg}$

Double mechanical seal: $p_{fl} = \text{sealing pressure of the mechanical seal min. } 2 \text{ barg, max. } 14 \text{ barg, (}\Rightarrow \text{ section 7.3.2 and 7.3.3)}$.

The mechanical seal must be pressurized during the entire sealing process.

- 2) The inlet or suction line as well as the pump body must be filled with liquid. Ensure that the pump body is completely and sufficiently deaerated.

 DANGER	<p>Impermissible temperatures due to dry running of the mechanical seal</p> <p>Explosion hazard. Destruction of the mechanical seal.</p> <ul style="list-style-type: none"> ✓ Before commissioning, completely de-aerate the pump and the existing sealing pressure chamber. ✓ Only operate the pump when it is completely filled.
---	--

- 3) Valves on the suction side must be completely opened. Discharge-side shut-off valves should preferably be slightly opened so that the pump is not operated against a closed valve, i.e. operation at zero delivery. However, if due to the plant conditions, the pump must be started against closed shut-off valves, this may result in an inadmissible heating of the pump.

 DANGER	<p>Overheating of the pump by operating against a closed slide valve</p> <p>Explosion hazard due to inadmissible temperatures. Destruction by bursting. Danger to persons and the environment from spraying fluid.</p> <ul style="list-style-type: none"> ✓ The valve on the suction side must always be open before commissioning. ✓ The pump may be operated against a closed shut-off valve only during starting and only for one minute at the most.
---	--

The manufacturer's consent is required if it is to be operated with closed shut-down fittings for longer periods of time. The pump may be started against a closed check valve (⇒ section 5.3.7).



4) The drive is started up.

 CAUTION	<p>Liquid splashing out</p> <p>Danger to persons and the environment.</p> <ul style="list-style-type: none"> ✓ Wear suitable protective clothing. ✓ Check pump for leaks. ➤ Troubleshoot cause of leakage.
--	--

5) Control valves on the discharge side must be opened so far that the nominal volume flow is reached.

	<p>Notice</p> <p>The volume flow may only be controlled by control valves in the pressure line.</p>
---	--

If during operation it is expected that the shut-down fittings on the discharge side will be closed down, then a bypass must be installed in front of these and returned to the suction tank (not to the suction nozzle!). This is the only way in which overheating of the pump can be avoided.

 DANGER 	<p>Overheating of the engine due to too frequent starting</p> <p>Explosion hazard due to inadmissible temperatures. Damage to the motor. Increased coupling wear.</p> <ul style="list-style-type: none"> ✓ Observe the permissible switching frequency according to the operating mode of the motor (⇒ motor operating instructions). ✓ Use a suitable starting aid.
--	---





If the pump is being switched continuously (i.e. more than 3 switching on processes per hour) an auxiliary start-up device should be installed (star- triangle-switch, electronic smooth start up device, hydraulic clutch or similar) in order to reduce mechanical strain. The use of this type of device depends on the utilisation factor of the machine (coupling performance, speed, switching frequency) and should be discussed with the manufacturer.

 ATTENTION	<p>Abnormal noises, leaks, inadmissibly high vibrations or temperatures</p> <p>Damage to the pump or pump unit.</p> <ul style="list-style-type: none"> ✓ Switch off the pump unit in a controlled manner. ✓ Find out the cause and eliminate it.
--	---

6.3 Operating the pump

✓ Observe the application limits of the pump (⇒ section 4.2).

During operation see to it that due to changes no inadmissible operating conditions may occur. These are in particular:

 DANGER	<p>Discharge-side modifications</p> <p>Explosion hazard due to inadmissible temperatures of the pumped medium. Impermissible surface temperatures. Destruction of the mechanical seal due to dry running.</p> <ul style="list-style-type: none"> ✓ Observe minimum volume flow and maximum permissible volume flow (⇒ section 4.2.4). ✓ Prevent inadmissible opening or closing of valves. ✓ Prevent changes in pipe resistance, for example due to contamination. ✓ If applicable: Monitor and clean the filter with a differential pressure measurement. ✓ If possible, operate the pump at the specified operating point. ✓ Do not exceed the rated power of the motor.
 DANGER	<p>Suction-side modifications</p> <p>Explosion hazard due to inadmissible temperatures. Risk of dry running. Destruction of the mechanical seal.</p> <ul style="list-style-type: none"> ✓ Prevent inadmissible opening or closing of valves. ✓ Avoid reducing the inlet pressure by, for example: <ul style="list-style-type: none"> - Contamination of filters, pipes and fittings - increased pipe resistance due to unfavourable pipe runs - by the properties of the medium.
 DANGER	<p>Not or not sufficient supply of the additional connections</p> <p>Explosion hazard due to inadmissible temperatures. Risk of dry running. Destruction of the parts to be lubricated.</p> <ul style="list-style-type: none"> ✓ The required pressure and volume flow at additional connections such as sealing liquid, flushing liquid etc. must be ensured by the operator (⇒ Sections 5.4 and 7.3). This applies in particular for quench and external flushing. Here, sufficient cooling and lubrication of the radial shaft seal ring or the mechanical seal must be ensured. ✓ Check supply connections regularly.
 DANGER	<p>Insufficiently filled suction tank</p> <p>Explosion hazard due to inadmissible temperatures. Danger of dry running! Destruction of the mechanical seal.</p> <ul style="list-style-type: none"> ✓ The suction tank must always be sufficiently filled. ✓ The design of the suction tank must be sufficient for the respective operating case.

✓ Observe the monitoring and maintenance of the bearing arrangement (⇒ section 7.2).

6.4 Short shutdown of the pump

Proceed as follows for short-term shutdown:

- ✓ Leave the suction-side shut-off valve open.
 - ✓ Existing flushing and sealing liquid supply and quench application must be maintained even after the drive unit has been switched off.
- 1) The shut-down fitting on the discharge side is to be closed or turned to minimum volume (after the motor has been switched off, it must be closed completely).
 - 2) Switch off the drive unit.
 - 3) If there is a risk of freezing, the pumped liquid must be removed from the pump.

6.5 Shutting the pump down permanently

The following steps must be carried out if the pump is to be shut down permanently:

- 1) The shut-down fitting on the discharge side is to be closed or turned to minimum volume (after the motor has been switched off, it must be closed completely).
- 2) Switch off the drive unit.
- 3) Relaxation and draining of the entire system including the pump.
- 4) Switch off the flushing and sealing liquid supply and quench application. If the pumped liquid tends to crystallize, rinse the pump with clean water.
- 5) Close the suction-side shut-off valve.
- 6) If there is a risk of freezing, the pumped liquid must be removed from the pump. The mechanical seal chamber must also be completely drained. For the continuous flushing, quench and double mechanical seal versions, the inner area must be blown free with compressed air. To do this, connect compressed air (3–4 bar) to the flushing connection. For this purpose, pressure must first be relieved, for example by means of a vent valve or the suction or pressure side flap. To blow out the seal chamber of a double-acting mechanical seal, connect compressed air to a connection for the seal liquid.

 CAUTION	<p>Liquid splashing out</p> <p>Danger to persons and the environment.</p> <ul style="list-style-type: none"> ✓ Collect splashing sealing liquid suitably.
--	--





- 7) An elastomer bellows must be relaxed. By relaxing the elastomer bellows, its elasticity is maintained. Before commissioning, the bellows must be tightened again in accordance with the operating instructions.

	<p>Notice</p> <p>If the machine is to be taken out of service for longer than one year, replace the elastomers.</p>
---	---

6.6 Reverse flow through the pump









The pump may be backwashed for cleaning or for process reasons. Due to the backward flow, the impeller is driven against the usual direction of rotation. The impeller cannot be separated from the shaft by backward flow.

- ✓ Equipment for personal protection must be installed ⇒ section 6.1.4.
- ✓ Prevent inadmissible speeds.

	<p>Notice</p> <p>The motor must not be started during reverse flow. Illegal starting of the motor during reverse flow of the pump can lead to mechanical damage.</p> <ul style="list-style-type: none"> ✓ Prevent inadmissible switching on of the motor.
	<p>Notice</p> <p>Supply of the additional connections</p> <ul style="list-style-type: none"> ✓ The required pressure and volume flow at additional connections such as flushing liquid etc. must be ensured by the operator (⇒ sections 5.4 und 7.3). This applies in particular for quench and flushing liquids. Here, sufficient cooling and lubrication of the radial shaft seal or the mechanical seal must be ensured.
 WARNING  	<p>The motor is operated as a generator with reverse flow.</p> <p>Personal injury by touching rotating parts or flying out coupling parts.</p> <p>Illegal speed. Electrical currents and voltages!</p> <ul style="list-style-type: none"> ✓ If necessary: Uncouple the motor. ✓ Observe the operating instructions of the motor.

7. Maintenance/ Service

7.1 Safety regulations

 DANGER	Sparks and discharges during maintenance work
	Explosion hazard! <ul style="list-style-type: none"> ✓ Do not carry out maintenance work in hazardous areas. ✓ Prevent sparks and discharges.
 DANGER	Hot surfaces, leakages
	Explosion hazard due to inadmissible temperatures! Increased wear. <ul style="list-style-type: none"> ✓ Carry out maintenance work according to the maintenance schedule (⇒ section 7.2.3).
 WARNING	Unauthorized starting of the motor
 	Personal injury by touching rotating parts or flying out coupling parts. Impermissible surface temperatures. Sparking due to friction! Explosion hazard. <ul style="list-style-type: none"> ✓ Before working on the coupling, the motor must be safely disconnected from the mains supply. ✓ Prevent inadmissible switching on of the motor. ✓ Observe the operating instructions of the motor.
 ATTENTION	Hazardous and/or hot pumped media and flushing media, lubricants
	Risk to persons and the environment. <ul style="list-style-type: none"> ✓ Wear suitable protective clothing. ✓ Empty pump, supply lines and connections completely and clean. ✓ Collect residual media. ✓ Avoid contact with pumped medium and residual media. ✓ Dispose of hazardous materials in accordance with local regulations. ✓ Decontaminate pump.
 WARNING	Insufficient stability
	Squeezing hands and feet. <ul style="list-style-type: none"> ✓ Ensure stability when working on the pump, pump unit and pump parts. ✓ Observe transport regulations (⇒ section 3.1).

7.2 Monitoring and maintenance of shaft bearings



The pumps are equipped with roller bearings.

The bearing temperature can exceed the environment temperature by up to 60°C in case of permanent use.



 CAUTION	Hot surface
	Risk of injury. <ul style="list-style-type: none"> ✓ Do not touch hot bearings.

The bearings must be checked and/or controlled regularly.



The bearings are suitable for a nominal lifespan of 16.000 operating hours. After this period, a vibration test should be carried out, which must be repeated from time to time depending on the working conditions of the roller bearings. The vibration values according to DIN ISO 10816-7 should be respected.

 DANGER	Hot surface
	<p>Hazard of explosion due to inadmissible temperatures. Increased wear.</p> <ul style="list-style-type: none"> ✓ Check the wear condition of the roller bearings. ✓ Measure bearing temperature. ✓ For pumps used in potentially explosive atmospheres: If the operator cannot carry out a suitable inspection of the roller bearings, the roller bearings must be replaced after the nominal service life has expired.

If the pump is not to be used in a potentially explosive atmosphere, the bearings must be checked and replaced if necessary after the nominal service life has expired or after 3 years at the latest.

 DANGER	Impermissible vibration speeds
	<p>Hazard of explosion due to inadmissible temperatures. Increased wear.</p> <ul style="list-style-type: none"> ✓ A pump used in a potentially explosive atmosphere is assigned to category I in accordance with DIN ISO 10816-7. The pump must therefore meet the vibration velocities in accordance with DIN ISO 10816-7, Zone A or B. ✓ If higher vibration speeds occur due to bearing wear, these must be replaced as soon as possible. ✓ In critical applications we recommend continuous vibration monitoring.

The nominal life is calculated for continuous operation. Deviations from this operating mode can lead to considerable deviations in the service life of the bearings.

 DANGER	Deficient lubrication of the bearings
	<p>Hazard of explosion due to inadmissible temperatures. Increased wear. Destruction of the bearings.</p> <ul style="list-style-type: none"> ✓ Oil lubrication: Carry out initial filling. Check filling level (⇒ section 7.2.2). ✓ Observe relubrication intervals for bearings that can be relubricated with grease. ✓ Observe the restriction of the temperature class due to the type of lubrication (⇒ section 2.9.6).

7.2.1 Grease lubrication

Unless otherwise specified, lifetime-lubricated bearings are provided. Regreasable bearings may optionally be selected.

7.2.1.1 Lifetime-lubricated bearings

The lifetime-lubricated grooved ball bearings are serially designed with guard disks on both sides. The bearings sealed on both sides are lifetime-lubricated and maintenance-free. Therefore, prior to installation, they should by no means be heated to above 80°C or rinsed. The grooved ball bearings are filled with standard lubricating greases. The lubricating grease has good anti-corrosive properties and contains lithium soap as thickener.

7.2.1.2 Grease, relubricable

Bearings lubricated using grease are filled with suitable grease at the manufacturer's. It is not necessary to re-lubricate before starting up, in fact this would even be damaging as it can lead to the bearing overheating.

New grease is applied in the spaces of the bearing cage. The grease chambers must only be one third full of grease as too much grease will cause the bearings to overheat.

The greases which can be used have the following abbreviation according to DIN 51502:

K P 2 K -30.



K	P	2	K	-30
				Lower operating temperature in °C
				Upper operating temperature and behaviour towards water, K: 120 °C
				Consistency classification in NLGI class
				Additional letter(s) for base oil type and additives, P: EP/AW additives
Code letter for grease type, K: Rolling bearing, plain bearing, sliding surfaces according to DIN 51825				

Properties of the grease:

Basicoil:	Mineral oil	Basic oil viscosity at 100 °C:	11 mm ² /s
Soap:	Lithium-Calcium	Characteristic value of RPM:	600.000 mm/min
Operating temperature:	-30 to 120 °C	Flexing penetration at 25 °C:	265-295
Basic oil viscosity at 40 °C:	100 mm ² /s	Consistency class:	2

7.2.2 Oil lubrication

Ex factory, the pumps are delivered without oil filling. In case of oil-lubricated bearings, the bearing housing, prior to commissioning, must be filled through the top filling opening until the oil has reached the middle of the oil-level gauge. If preferred, the bearing housing can be equipped with an oil regulator (constant level oiler) instead of the oil level sight glass.

 ATTENTION	<p>Oil leakage due to excessive filling level in the bearing pedestal Danger to persons and the environment from oil leakage.</p> <ul style="list-style-type: none"> ✓ Version oil sight glass: Fill the bearing housing to the middle of the oil level sight glass. ✓ Constant-Level-Oiler version: Oil must be filled in via the filling port S1 until the oil appears in the screwed-in element of the tilted oil regulator. The oil level of the bearing housing must not exceed this level as otherwise oil leaks at the ventilation channel of the constant level oiler (⇒ Fig. 7.1). ✓ Please take great care to ensure that the cork seal under the glass container of the constant level oiler is exactly central under the edge of the glass and that the glass container is screwed on tight. Do not screw it too tight, as this will cause the cork seal to slip and this in turn will cause oil to leak. The glass container should also never be removed from its holder.
	<p>Notice A visual inspection must be performed at regular intervals. If the oil level is too low, oil must be refilled.</p>

An oil change should be performed annually, at the latest, however, after 10,000 operating hours.

The lubricating oils are to be selected according to the ambient temperature. In case of ambient temperatures between 0°C and 40°C, CLP oils of viscosity class ISO VG 68–100, DIN 51517–3, have to be used (SAE 20–30).

Properties	CLP		Test in accordance with
	68	100	
ISO VG	68	100	DIN 51519
Ambient temperature	-10 ... +30 °C	0 ... +40 °C	
Lower operating temperature	-15 °C	-5 °C	
Upper operating temperature	+100 °C	+100 °C	
Kinematic viscosity			DIN EN ISO 3104
At 40 °C	68 mm ² /s	100 mm ² /s	
at 100 °C, approx.	8,7 mm ² /s	11,2 mm ² /s	
Viscosity index	≥90	≥90	DIN ISO 2909
Density at 15 °C; approx.	886 kg/m ³	890 kg/m ³	DIN 51757
Flash point	≥200 °C	≥200 °C	DIN ISO 2592
Pourpoint	≤-15 °C	≤-15 °C	DIN ISO 3016

If ambient temperatures deviate from this, the required lubricating oil qualities must be agreed with the manufacturer in each individual case.

The required filling quantities can be found in the following list:

- | | |
|--|--|
| Bearing housing size 0: ca. 0,15 Liter | Bearing housing size III: ca. 1,6 Liter |
| Bearing housing size I: ca. 0,8 Liter | Bearing housing size IV: ca. 1,7 Liter (standard design) |
| Bearing housing size II: ca. 1,0 Liter | Bearing housing size IV: ca. 2,2 Liter (long design) |

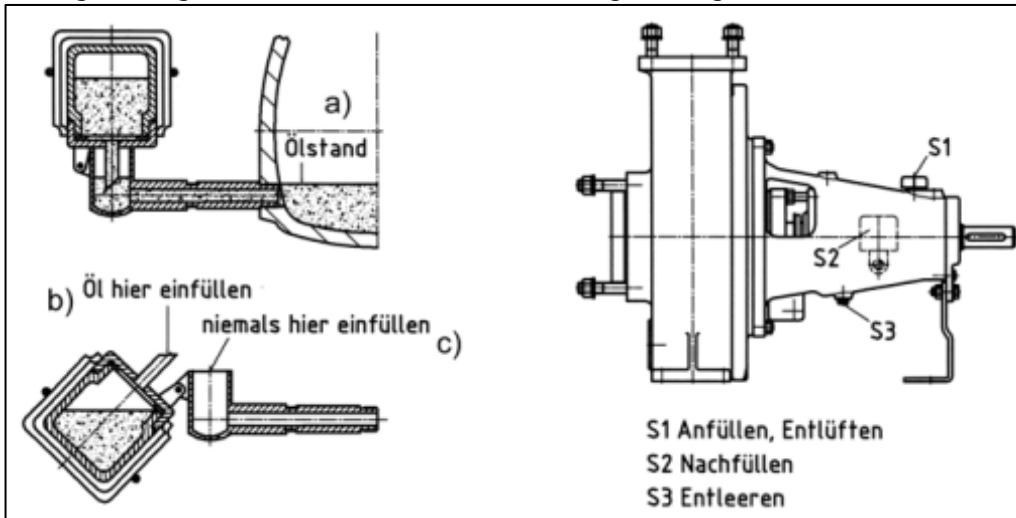

Legend to Fig. 7.1
 a) Oil level
 b) Fill oil here
 c) never fill in here
 S1 fill, de-air
 S2 refill
 S3 drain off

Fig. 7.1 Oil lubrication and constant level oiler

7.2.3 Inspection, maintenance, intervals and tasks

Depending on the design variant, we recommend to carry out the following tasks according to the respective intervals.



Design variant		Inspection			Maintenance		
		Interval according to category		Task	Interval according to category		Task
		Category I	Category II		Category I	Category II	
Shaft bearing type of lubrication	Lifetime lubricated bearings	Weekly	quarter-annually	Vibrations, bearing noises, check temperature of bearing housing.	16000 operating hours at the latest after 3 years	16000 operating hours at the latest after 3 years	Check bearing, replace bearing if necessary.
	Grease, relubricable	Weekly	quarter-annually	Vibrations, bearing noises, check temperature of bearing housing, bearing cover and end bearing cover for leaks.	If the time for maintenance is after the lubricating period has expired (see table Lubricating period), the bearings must be regreased as follows: Interval according to speed: 2-pole: 2000 h 4,6,8-pole: 4000 h operating hours	If the time for maintenance is after the lubricating period has expired (see table Lubricating period), the bearings must be regreased as follows: Interval according to speed: 2-pole: 2000 h 4,6,8-pole: 4000 h operating hours	Grease with grease gun A+B bearing during operation. Take the quantity per bearing from the table for lubrication intervals. Grease: K P 2 K -30, DIN 51502
					16000 operating hours at the latest after 3 years <i>If the operator deviates from this interval, the intervals for relubrication must be observed if the lubrication period is exceeded.</i>	16000 operating hours at the latest after 3 years	Check bearing, replace if necessary Clean bearings, grease again, Fill 2/3 of the rolling bearings with grease. Do not fill bearing and end bearing caps with grease. Initial filling per bearing: Size 0 / 0.050 kg Size 1 / 0.050 kg Size 2 / 0.075 kg Size 3 / 0.100 kg Size 4 / 0.150 kg
					annually, at the latest after 10000 operating hours	annually, at the latest after 10000 operating hours	Oil change: Size of bearing housing / Quantity Size 1 / 0.8 litres Size 2 / 1.0 litres Size 3 / 1.6 litres Size 4 / 1.7 litres Size 4 long / 2.2 litres

Design variant		Inspection			Maintenance		
		Interval according to category		Task	Interval according to category		Task
		Category I	Category II		Category I	Category II	
	Oil lubrication	Weekly	quarter-annually	Vibrations, bearing noises, bearing housing temperature, Level Check filling level: Centre of oil level gauge or Constant-Level-Oiler must contain oil, Quantity refill: as required, Check bearing cover and end bearing cover for leaks. CLP oil, ISO VG 68-100, DIN 51517-3 (SAE 20-30)	16000 operating hours at the latest after 3 years	16000 operating hours at the latest after 3 years	Check bearings, replace bearings if necessary, Clean bearings, Change oil.
Pump housing, connections	all	Weekly	quarter-annually	Check pump for leakage.	-	-	-
Mechanical seal	all	Weekly	Monthly	Check mechanical seal for leakage.	-	-	-
Thermosiphon system	double-acting mechanical seal	Weekly	Monthly	Check filling level, pressure, temperature, tightness of the connection lines.	-	-	Observe operating instructions for thermosiphon system.
Stand quench container	Quench	Weekly	Monthly	Level, condition Check quench liquid optically, if crystallisation occurs, clean the impurities and change the liquid.	-	-	-
Continuous rinsing device	Dauerspülung	Weekly	Monthly	Check the flushing quantity according to the operating instructions.	-	-	-
O-rings	all	-	-	-	When opening the pump.	When opening the pump.	Replace O-rings at open seals.
Coupling	Flender N-EUPEX® or equivalent	-	-	-	For the first time after 3 months, thereafter annually	For the first time after 3 months, thereafter annually	Check the flexible elements used for wear and torsional backlash in accordance with the operating instructions for the coupling and replace if necessary.
Touching protection for coupling and splash guard (hood)	all	quarter-annually	quarter-annually	Check for damage, deformation, proper assembly and sufficient clearance from rotating parts.	-	-	-

Design variant	Inspection			Maintenance		
	Interval according to category		Task	Interval according to category		Task
	Category I	Category II		Category I	Category II	
Filters	all	weekly, depending on degree of contamination Adjust interval	weekly, depending on degree of contamination Adjust interval	Check for contamination by taking suitable measures (differential pressure measurement), Cleaning the filter	-	-

Size of bearing housing	Deep groove ball bearings	Grease quantity for relubrication per bearing in g	Lubricating period t_{lg}					
			50 Hz			60 Hz		
			6-polig up to 1000 rpm	4-polig up to 1500 rpm	2-polig up to 3000 rpm	6-polig up to 1200 rpm	4-polig up to 1800 rpm	2-polig up to 3600 rpm
0	6306ZC3	4	35000	25000	16000	29000	20000	12000
1	6307ZC3	5	30000	21000	13000	24000	19000	10000
2	6309ZC3	8	24000	20000	10000	20000	17000	8000
3	6313ZC3	14	20000	16000	7500	16000	12000	6000
4	standard design							
	6318ZC3	25	16000	10000	-	13000	9000	-
	4 long design							
	6318ZC3	25	16000	10000	-	13000	9000	-

Interval for maintenance: 16000 operating hours

	Notice If maintenance is carried out before the end of the lubrication period, no relubrication of the bearings is necessary until maintenance.
	Notice The type of bearing is described in the parts list.

Based on ISO 10816-7:2009:

Category I: Pumps with high reliability, availability or safety requirements (e.g. pumps for toxic and/or hazardous liquids, pumps for critical use, pumps for use in the oil and gas industry, in nuclear or other power stations);

Category II: pumps for general or less critical use (e.g. for non-hazardous liquids)



Depending on the necessary availability of the pump or the risk of damage, the operator must suitably shorten the inspection interval.

Inspection, maintenance and preventive servicing of other machines and equipment such as motors or belt drives must be carried out in accordance with the relevant operating instructions.

7.3 Supply of mechanical seals

The designs of the mechanical seal types are described in ⇒ section 4.5.

This applies to all supply media of the mechanical seal:

 <p>ATTENTION</p>	<p>Chemically incompatible Chemical reaction. Increased wear. Risk of freezing.</p> <ul style="list-style-type: none"> ✓ The operator must ensure the chemical compatibility of the flushing, sealing and quench medium with the pumped medium and the parts of the pump and supply equipment that come into contact with the product – see also (⇒ section 2.9.12). ✓ The liquid must be selected according to the ambient temperature to be expected so that the medium cannot freeze.
	<p>Notice With a double-acting mechanical seal, the sealing medium enters the pumped medium in small quantities, so chemical compatibility and, if necessary, food suitability must be ensured.</p>

Order-related documents have priority.

7.3.1 Single-acting mechanical seals

⇒ sections 4.5.1, 4.5.2

a) Interior rinsing:

No exterior supply necessary

b) Interior rinsing with quench:

Medium: usually, clean, filtered water, particle size ≤ 50µm

Gauge pressure: 0.7 to 8.5 bar before flow regulator

Volume: 30 litres per hour (will adjust itself)

c) Continuous rinsing:

Medium: usually, clean, filtered water, particle size ≤ 50µm

Volume: 40–250 litres per hour, depending on pump size, see (⇒ chapter 13)

20–125 LPH possible for SSIC/SSIC mechanical seal arrangement. In this case the sealing-area is not rinsed completely.

d) Rinsing after use:

Medium: usually industrial water

Volume: approx. 40 litres for a rinsing period of 5 minutes (minimum)

7.3.2 Double acting mechanical seals – DIN EN 12756

as defined by section 4.5.3

Medium: usually clean, filtered water, particle size ≤ 50µm

Overpressure: 0,75 x suction pressure + 0,25 x max. final pressure + 1,5 bar
 (suction and discharge pressure measured at pump nozzle)

Volume: 30–120 litres per hour, depending on pump size and speed

	<p>Notice The application limits of the respective mechanical seal must be observed. Observe the operating instructions and data sheets for the mechanical seal.</p>
---	--

7.3.3 Stationary double acting mechanical seals

as defined by section 4.5.4

Medium: usually clean, filtered water, particle size ≤ 50µm

Overpressure: 0,75 x suction pressure + 0,25 x max. final pressure + 1,5 bar
(suction and discharge pressure measured at pump nozzle)

For EagleBurgmann HRZ13 applies:



Max. pressure to be sealed: $p_1 \leq 14$ bar

Max. permissible sealing pressure: $p_3 \leq 16$ bar, too high sealing pressure leads to increased wear of the mechanical seal.

Sealing medium – permissible return flow temperature and minimum volume flow:

The maximum permissible return flow temperature (temperature at the outlet from the sealing chamber of the mechanical seal) depends on the sealing medium used and must not be exceeded.

Sealing liquid	The maximum allowable return temperature
Oil (e.g. white oil)	80 °C
Demineralised water with lubricating additives (e.g. propylene glycol, glycerol; Recommended mixing ratio 70:30) ATTENTION! Viscosity and freezing point depend very much on the mixing ratio!	70 °C
Demineralised water	60 °C
Other suitable liquids	At least 40 °C below the boiling point at normal pressure

 DANGER	Too high temperature of the sealing medium
	Hazard of explosion. Destruction of the mechanical seal due to dry running. ✓ Observe the permissible return temperature of the sealing medium.

If a TS system is used, the volume on the mechanical seal will be self-adjusted by the pumping thread. The cooling capacity of the TS system is increased by connecting the cooling line. Depending on the quantity of heat to be removed, the cooling pipe must be connected. The quantity of heat to be discharged is calculated as a function of the speed, the temperature of the pumped liquid and the size of the mechanical seal.

In case of an external supply the following applies:

To maintain the maximum return temperature, the following minimum volume flow of the sealing liquid must be set according to the nominal speed and the bearing housing size and, if necessary, the minimum volume flow should be correspondingly increased or the inlet temperature to be reduced.

Speed rpm	Size of bearing housing				
	0	1	2	3	4
	Minimum volume flow of sealing liquid in l/h				
700	5	5	6	10	16
985	7	7	9	13	23
1450	9	10	13	20	33
2900	19	20	27	40	

If the speed is different at operation with a frequency converter or in the 60 Hz mains, the minimum volume flow must be increased linearly to the change of speed.

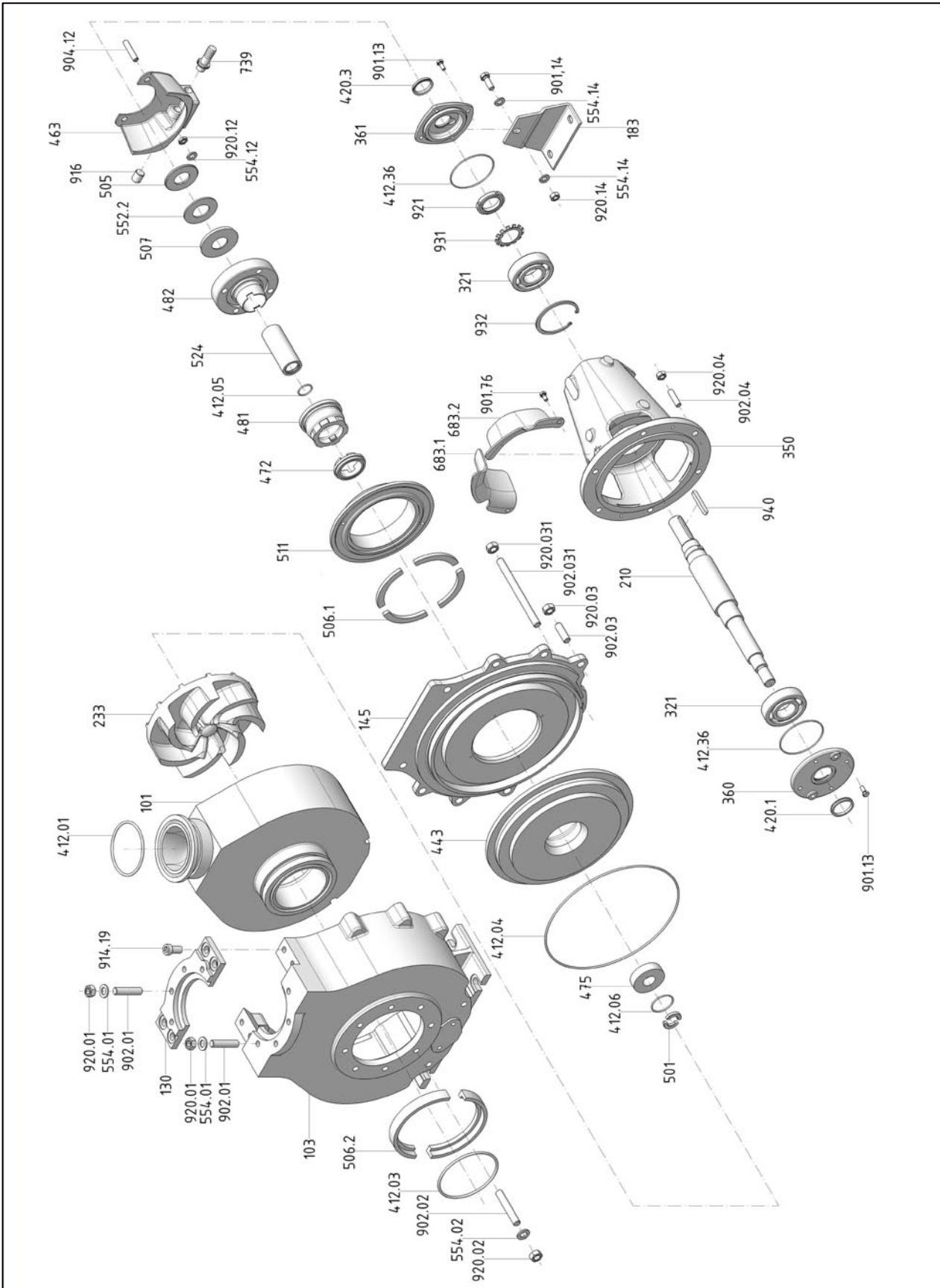





Fig. 7.2 Exploded view of the individual parts of the pump with single WERNERT-elastomere-bellows-mechanical seal and semi-open impeller.

7.4 Disassembly and assembly of the pump

 <p>! WARNING</p>	<p>Unauthorized starting of the motor</p> <p>Personal injury by touching rotating parts or flying out coupling parts. Impermissible surface temperatures. Sparking due to friction! Explosion hazard.</p> <ul style="list-style-type: none"> ✓ Before working on the coupling, the motor must be safely disconnected from the mains supply. ✓ Prevent inadmissible switching on of the motor. ✓ Observe the operating instructions of the motor.
 <p>! DANGER</p>	<p>Sparks and discharges during maintenance work</p> <p>Explosion hazard!</p> <ul style="list-style-type: none"> ✓ Do not carry out maintenance work in hazardous areas. ✓ Prevent sparks and discharges.

Disassembly and assembly of the pump are explained in two series of photographs. As a standard technical design we have chosen the WERNERT- elastomer bellows mechanical seal and the lifetime-lubricated grooved ball bearings. In the case of technical design deviating from this, the drawing cutouts in these operating instructions or the product-specific sectional drawing must be observed. The manufacturer also provides suitable product training upon request. Fig. 7.2 shows all the individual parts of this pump in the correct order of assembly. Observe tightening torques (⇒ chapter 12).

7.4.1 Disassembly of the pump

 <p>ATTENTION</p>	<p>Hazardous and/or hot pumped media, barrier and flushing media, lubricants</p> <p>Risk to persons and the environment.</p> <ul style="list-style-type: none"> ✓ Wear suitable protective clothing. ✓ Empty pump, supply lines and connections completely and clean. ✓ Collect residual media. ✓ Avoid contact with pumped medium and residual media. ✓ Dispose of hazardous materials in accordance with local regulations. ✓ Decontaminate pump.
--	--

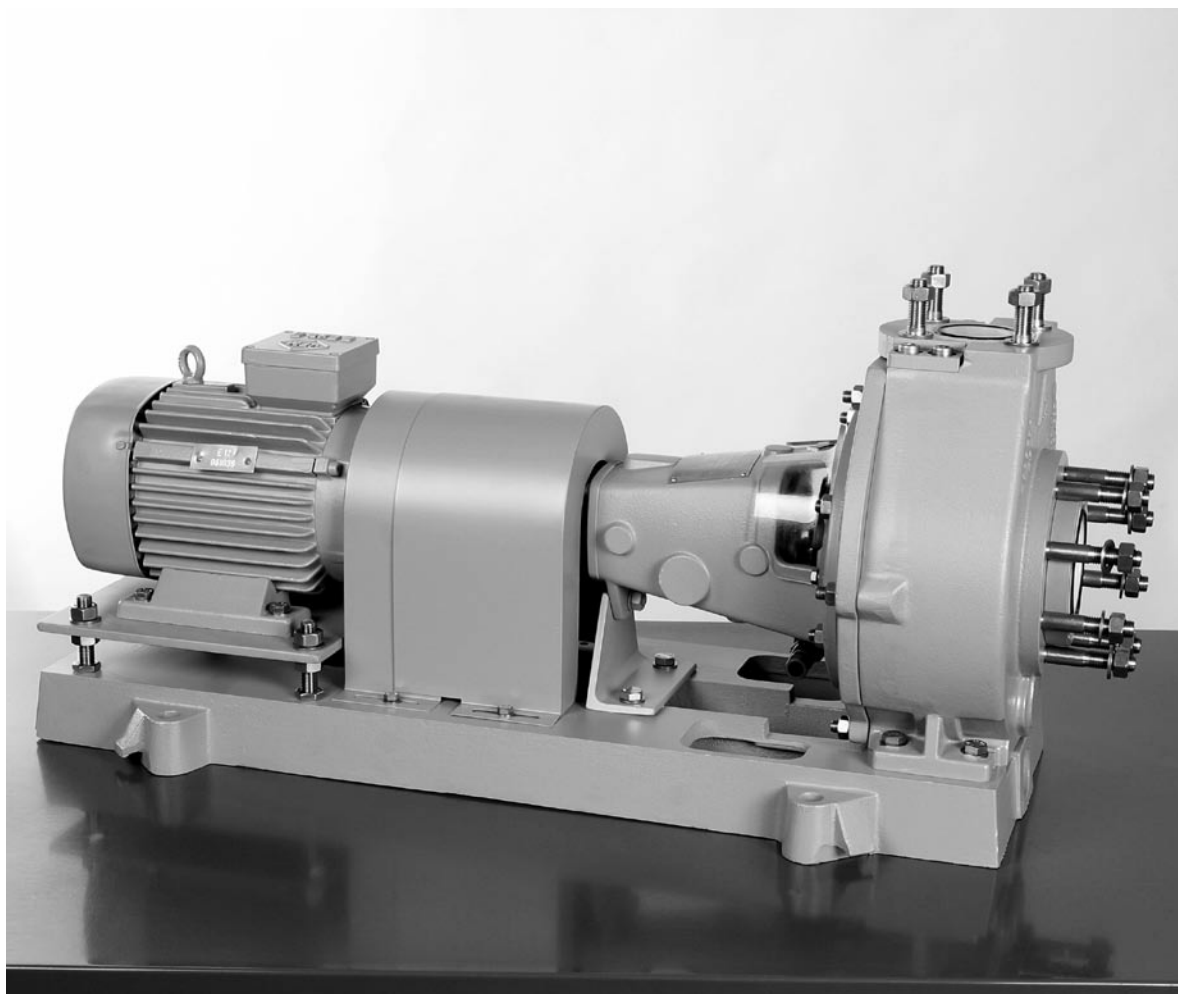

Fig. 7.3 Complete pump aggregate.



Fig. 7.4
Disconnect electric motor from power supply.
Remove touching protection.

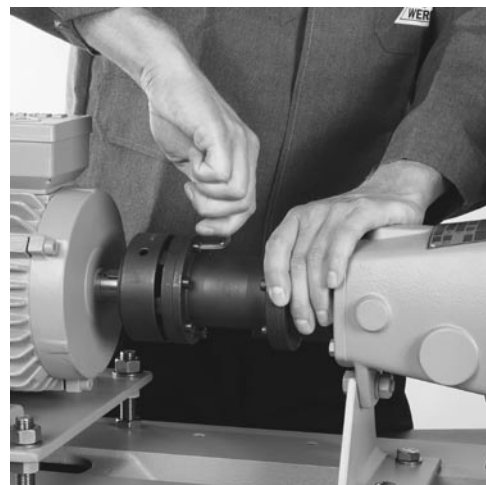

Fig. 7.5
Disassemble coupling between electric motor
and bearing housing whilst touching
protection is removed. Remove cylindrical
screw.

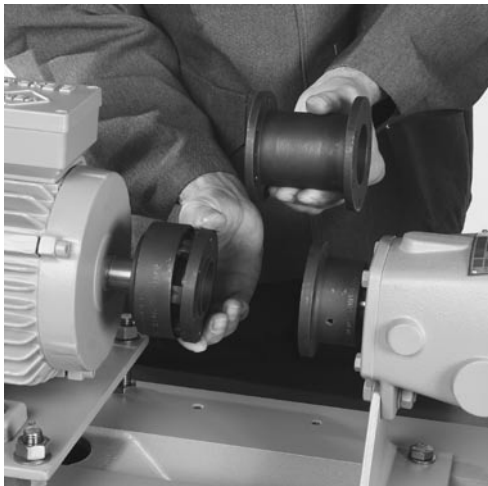

Fig. 7.6
Remove intermediate sleeve of the coupling.



Fig. 7.7
Take away hexagon nuts on adapter / annular casing and hexagon head bolts on support foot.



Fig. 7.8
Take away hexagon head bolts on bearing housing. Take away caps.



Fig. 7.9
Push off back-pull-out-unit from annular casing. Depending on liquid pumped take safety measures. Protect eyes! Danger of cauterization!

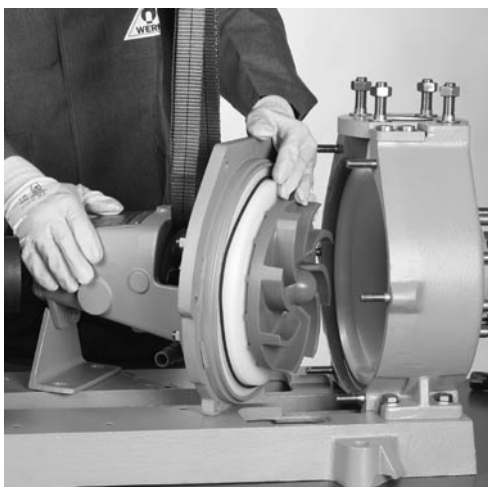

Fig. 7.10
Back-pull-out-unit is in disassembled state. The pump casing / annular casing can be left in the pipework.



Fig. 7.11
Loosen the semi-open impeller in sense of rotation of the pump using special tool (part 051). Fix shaft beforehand. Disassembly left-hand impeller size IV ⇒ section 4.6.3.



Fig. 7.12
Remove the multiple ring from the shaft using special tool (part 052) and remove the rotating seal ring.



Fig. 7.13
Remove existing rinsing connections. Loosen hexagon nuts to separate bearing housing from the adapter.



Fig. 7.14
Separate bearing housing and adapter using ejector screws. Pull out bearing housing with the shaft.



Fig. 7.15
Take bellows with stationary seal ring and bellows seat off the seal insert.



Fig. 7.16
Loosen connection of stationary seal ring, bellows and bellows seat by means of easy pulling.



Fig. 7.17
Press the centering ring from the adapter using ejector screws and remove centering ring.

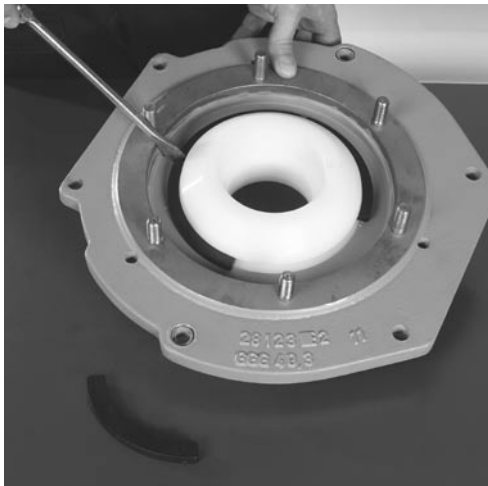

Fig. 7.18
Remove retaining rings from the seal insert.



Fig. 7.19
Separate adapter and seal insert using ejector screws.



Fig. 7.20
Pull shaft wearing sleeve with O-ring and locking disc system from the shaft.

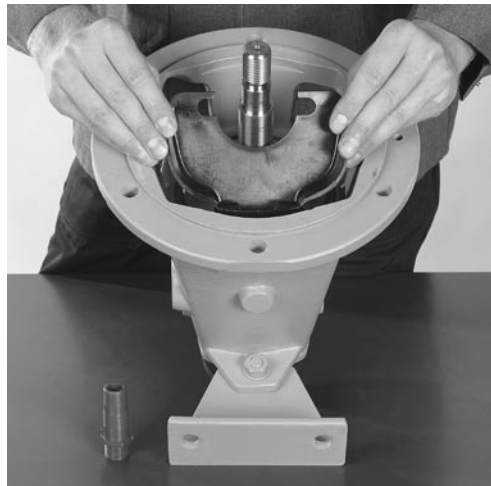

Fig. 7.21
Remove retaining screws of bellows seat and remove drip plate.

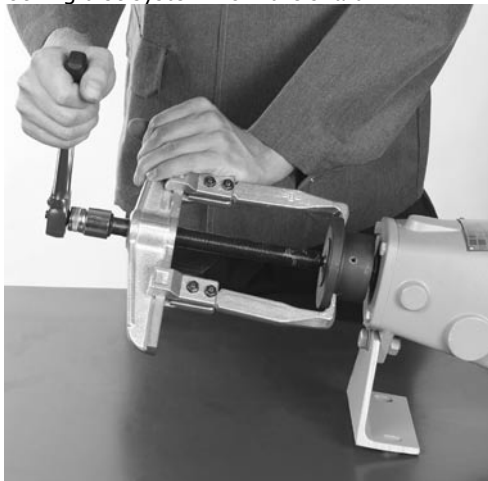

Fig. 7.22
Pull coupling part from shaft end. Loosen safety screw first.



Fig. 7.23
Remove key. Take shaft seal ring off the shaft.



Fig. 7.24
Remove screws at bearing end cover.



Fig. 7.25
Take off bearing end cover and O-ring.



Fig. 7.26
Take shaft seal ring off the shaft. Remove the hexagon head bolts from the bearing cover. Remove bearing cover.



Fig. 7.27
Push shaft with radial ball bearings off the bearing housing by carefully beating against the front face of the threaded journal with a plastic hammer.



Fig. 7.28
When the bearing on the side of the motor lies exposed press the circlip together with a round nose pliers and remove it from the nut.

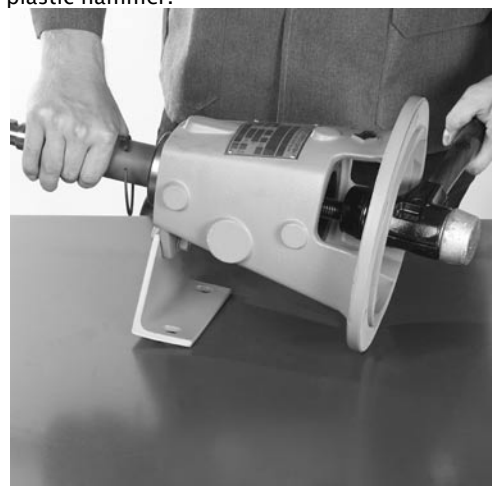

Fig. 7.29
Now the pump shaft with the radial ball bearings can be completely drifted out.



Fig. 7.30
Bearing housing, pump shaft with radial ball bearings and circlip, bearing covers with O-rings and radial shaft seal rings.



Fig. 7.31
Remove radial ball bearings by means of a removal device. The removed shaft nut and circlip are lying beside it.

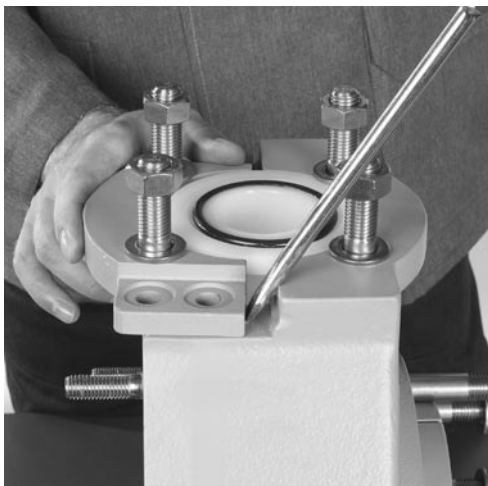

Fig. 7.32
Loosen hexagon head bolts on the casing part and remove casing part.

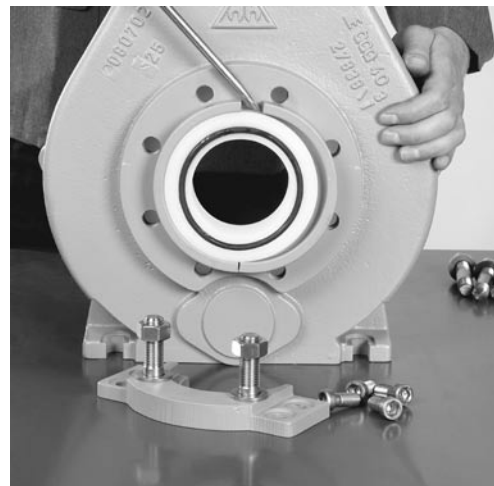

Fig. 7.33
Lever the retaining rings on pump casing. Remove studs beforehand.



Fig. 7.34
Remove pump casing from annular casing.

7.4.2 Assembly of the pump

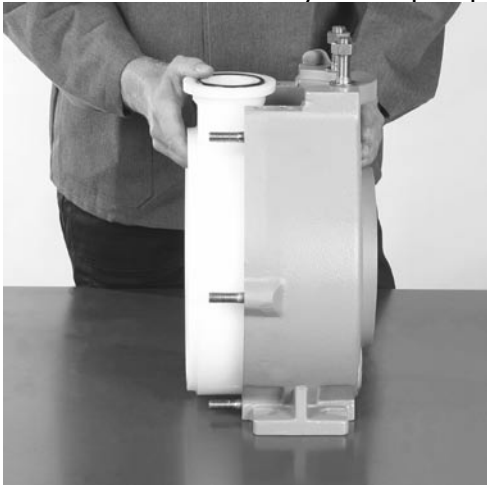

Fig. 7.35
Insert pump casing into annular casing.



Fig. 7.36
Insert retaining rings on suction nozzle, then tighten studs.



Fig. 7.37
Insert O-rings into nuts on suction and discharge nozzle. Slide casing part under the discharge nozzle and fix it. Attach all studs.



Fig. 7.38
Slide circlip over the shaft's waist, heat radial ball bearings and pull them onto shaft. In case of grease lubrication sealing discs must point inwards. Lubricate bearings according to operating instructions.



Fig. 7.39
Slide lockwasher onto shaft. Tighten shaft nut with spanner. Lock shaft nut with lockwasher.

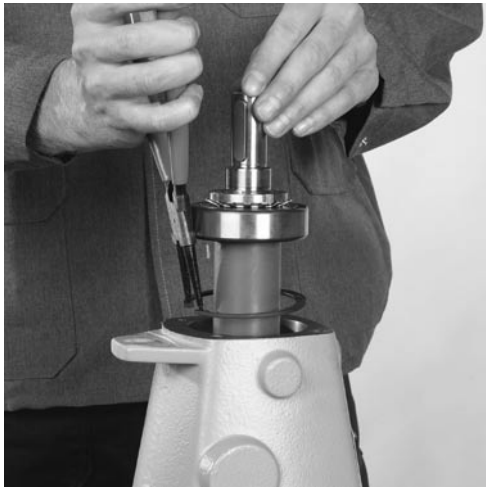

Fig. 7.40
Bearing housing, pump shaft with radial ball bearings and circlip, bearing covers with O-rings and shaft seal rings.

**Fig. 7.41**

Push shaft into bearing housing. Press circlip together with a round nose pliers and insert it into nut in bearing housing.

**Fig. 7.42**

When the shaft has reached its stop screw the bearing end cover with O-ring onto bearing housing.

**Fig. 7.43**

At bearing end cover slip shaft seal ring over shaft. Grease lip of shaft seal ring beforehand. For exact positioning use a special tool if necessary.

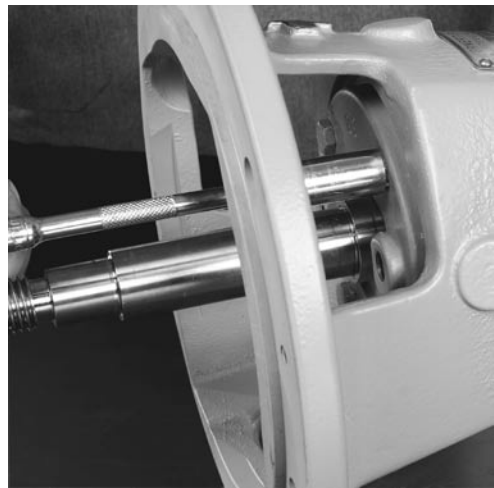
**Fig. 7.44**

Fit bearing cover with inserted O-ring into bearing housing and screw it tight. Oil groove must be orientated downward!

**Fig. 7.45**

Slip shaft seal ring over shaft at bearing cover. Grease lip of shaft seal ring beforehand. For exact positioning use a special tool if necessary.

**Fig. 7.46**

Fasten the support foot to bearing housing.

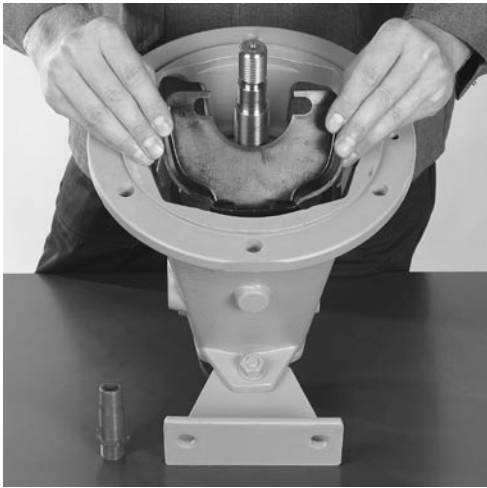

Fig. 7.47 Insert drip plate into bearing housing. Screw grub screws into bearing cover and screw on nuts. Fit washers.

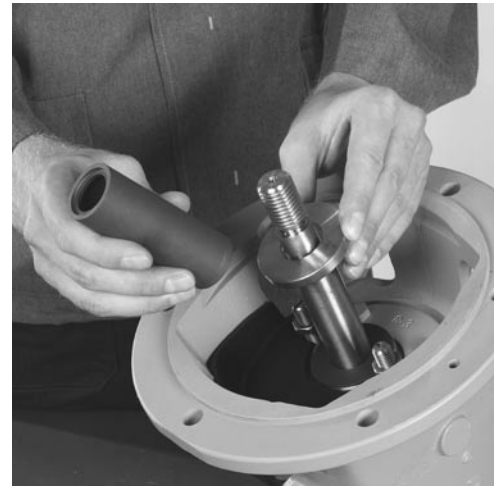

Fig. 7.48 Pull locking disc system and then shaft wearing sleeve with O-ring onto shaft. Pay attention to orientation of the locking disc system!



Fig. 7.49 Assemble bellows with stationary seal ring and bellows seat. Take care to line up grooves and cams on all three components.



Fig. 7.50 Place pre-assembled bellows seat onto the grub screws.



Fig. 7.51 Insert seal ring into adapter and secure it with the retaining ring made up in four-parts.

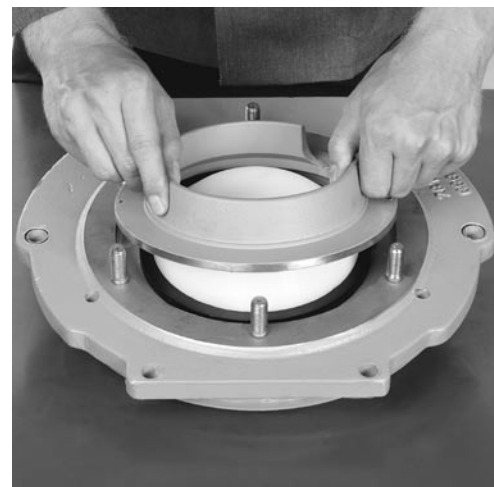

Fig. 7.52 Fit the centering ring which secures the four-part retaining ring into the adapter. Align nut for flushing connection.



Fig. 7.53
Carefully slide the pre-assembled adapter over the bellows into the bearing housing centre and screw tight.

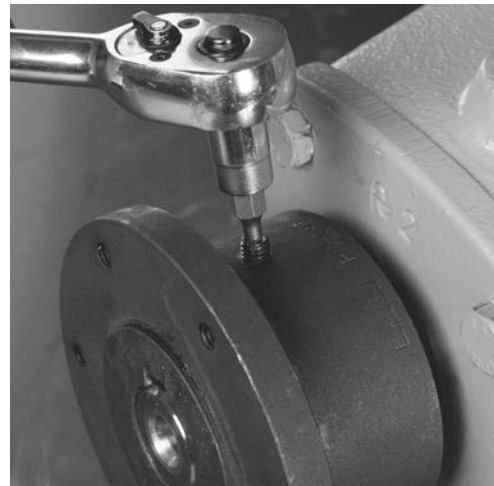

Fig. 7.54
Insert key into shaft, pull on coupling part and secure with grub screw. Grub screw must not project out.



Fig. 7.55
Place casing seal (O-ring) onto the seal insert, make sure it is correctly positioned.

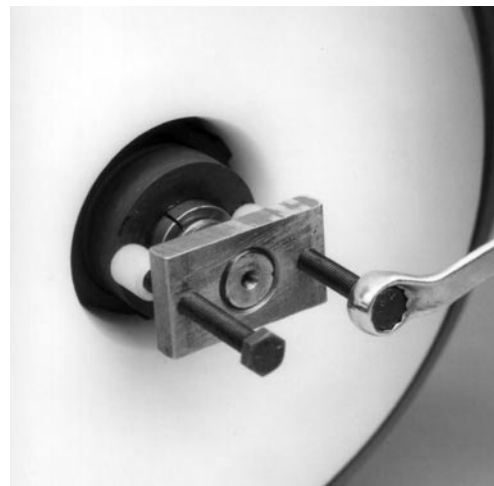

Fig. 7.56
Push rotating seal ring onto shaft, insert multiple ring using special tool (part 052) and remove special tool.



Fig. 7.57
Screw semi-open impeller with inserted O-ring onto shaft and tighten with special tool (part 051). Fix shaft beforehand.



Fig. 7.58
Insert back pull-out unit into pump casing and screw it to annular casing using locking screws and hexagon nuts.
For NEPE 100-65-315 and 80-50-315 the following applies: Centering is carried out via two drill sleeves (part 540).



Fig. 7.59
Tighten hexagon nuts on bellows seat following instructions (⇒ section 6.1.4). Avoid excessive tightening!



Fig. 7.60
Close pump nozzles tightly. Perform leakage test.



Fig. 7.61
Empty pump. If the pump is to go into storage, loosen hexagon nuts on the bellows. By loosening the nuts the bellows is keeping its elasticity.



Fig. 7.62
Assemble caps.

7.5 Leak test

After installation or repair, the pump should be subjected to a leak test before commissioning.

Perform the leak test when the pump is at a standstill and in the assembled or partially assembled condition. Clean, cold water should be used as the test liquid. The test pressure is usually calculated as follows:

$$p_D = p_B \times 1,5$$

$$p_B = H_{\max} [\text{m}] \times 9,81 [\text{m/s}^2] \times \rho [\text{kg/dm}^3] / 100 + p_{\text{Suction}} [\text{bar}]$$

p_D = Test overpressure in bar

p_B = permissible operating overpressure
(calculated taking into account the maximum head,
the density of the pumped medium and the inlet pressure)

H_{\max} = max. head of the installed impeller diameter in m

p_{Suction} = inlet overpressure in bar

ρ = density in kg/dm³

The following must be observed for a single mechanical seal:

A mechanical seal with elastomer bellows must be tightened according to the operating instructions and thus pretensioned (\Rightarrow section 6.1.4). If a test is to be carried out at a pressure higher than 6 barg, the mechanical seal must be removed and the pump suitably sealed. A leak test in partially assembled condition should therefore be avoided. Flush connections must be closed beforehand

For a double mechanical seal, the test overpressure must be less than the maximum allowable pressure of the mechanical seal used.

This applies to all mechanical seals:

In practice, a test overpressure of 4...5 bar has proved successful for a leak test.

 CAUTION	<p>Liquid splashing out</p> <p>Danger to persons.</p> <ul style="list-style-type: none"> ✓ Wear protective goggles. ➤ Check pump for leaks. ➤ Troubleshoot cause of leakage.
--	---

Procedure:

For pumps with sealing via O-rings on suction and discharge nozzles (Flat gaskets may only be used with pumps made of WERNIT):

Seal the suction side flange tightly with the O-ring and a blind flange with connection for a hand pump. Fill the pump completely with water using a hose from the discharge nozzle. Then seal the discharge branch tightly with the O-ring on the discharge side and a blind flange with connection for a pressure gauge. Set the required pressure using the hand pump mounted on the suction-side blind flange and check on the pressure gauge. This pressure must be maintained for 10...30 minutes. Check the pump for possible leaks. After the check, the pressure must be brought back to ambient pressure via the hand pump. The blind flanges can then be removed and the pump drained again.

If there is a risk of freezing, the pump must be completely drained after the test. This also applies if the pumped liquid is not chemically compatible with the test liquid.

7.6 Spare parts

Spare parts should only be ordered according to a parts list belonging to the pump, stating the identification number of the part and/or the serial number of the pump. For standard parts, stocking by the manufacturer or its subsidiaries guarantees short delivery times. However, for the parts listed below, it is always advisable to keep them in stock at the operator.

In general, the following criteria must be observed when selecting spare parts:

- Wear, corrosion or erosion during operation under design conditions and intended use of the pump;
- Damage to or destruction of a part during repair work (e.g. seals);
- Service life of a part in relation to the service life of the pump;
- Delivery time due to production time and location of the plant (distance from manufacturer, transport time, climatic conditions).

Wear parts after one year of operation (9,000 operating hours) are all wetted parts of the mechanical seal, i.e. for the single-acting WERNERT elastomer bellows mechanical seal:

- Part 472 Rotating seal ring
- Part 475 Stationary seal ring
- Part 481 Bellows (Bellows made of CSM will usually be replaced by the material EPDM)
- Part 552.2 Spanner (in locking system for shaft wearing sleeve)

The following O-rings should also be replaced regularly:

- Part 412.04 O-ring (casing seal)
- Part 412.05 O-ring (shaft wearing sleeve)
- Part 412.06 O-ring (impeller)

The following parts are recommended as spare parts after two years of pump operation (16.000 operating hours):

- Part 412.01 O-ring (discharge nozzle)
- Part 412.03 O-ring (suction nozzle)
- Part 420.1 Shaft seal ring (on bearing cover) (Lifetime lubricated bearings and oil lubrication)
- Part 420.3 Shaft seal ring (on bearing end cover) (Lifetime lubricated bearings and oil lubrication)
- Part 421.1 Radial shaft seal ring (on bearing cover) (grease, relubricable)
- Part 421.3 Radial shaft seal ring (on end bearing cover) (grease, relubricable)

For oil lubrication additionally:

- Part 322 cylindrical roller bearings
- Part 323 thrust ball bearing
- Part 412.36 O-ring (2 piece)

The following criteria are based on DIN 24296 and result in the following quantities of spare parts:

- two-year continuous operation
- Nominal life L_{10} of rolling bearings of at least 17500 hours
- Location: European Union



Part-No	Description	Number of pumps (including reserve pumps)						
		2	3	4	5	6 - 7	8 - 9	≥ 10
321	Grooved ball bearings (set)	1	1	2	2	2	3	25 %
322	Cylindrical roller bearings	1	1	2	2	2	3	25 %
323	Thrust ball bearings	1	1	2	2	2	3	25 %
412.01	O-ring	4	6	8	8	9	12	150 %
412.03	O-ring	4	6	8	8	9	12	150 %
412.04	O-ring	4	6	8	8	9	12	150 %
412.05	O-ring	4	6	8	8	9	10	100 %
412.06	O-ring	4	6	8	8	9	10	100 %
400, 412	Gasket, O-ring	4	6	8	8	9	10	100 %
420.1	V-Ring (Lifetime lubricated bearings and oil lubrication)	1	1	2	2	2	3	25 %
420.3	V-Ring (Lifetime lubricated bearings and oil lubrication)	1	1	2	2	2	3	25 %
421.1	Radial shaft seal ring (grease, relubricable)	1	1	2	2	2	3	25 %
421.3	Radial shaft seal ring (grease, relubricable)	1	1	2	2	2	3	25 %
472	Rotating seal ring	2	3	4	5	6	7	90 %
475	Stationary seal ring	2	3	4	5	6	7	90 %
481	Bellows	2	3	4	5	6	7	90 %
501	Multiple ring	-	-	1	2	2	2	20 %
505	Loose collar	-	-	1	2	2	2	20 %
507	Thrower	-	-	1	2	2	2	20 %
524	Shaft wearing sleeve	-	-	1	2	2	2	20 %
552.2	Spanner	1	1	1	2	2	2	20 %
-	Coupling Transmission elements (set)	1	1	2	2	3	4	30 %
For version with double mechanical seal:								
433	Double mechanical seal	1	1	2	2	2	3	25 %

Table: Spare part selection for the usual requirements

The following information is required for ordering spare parts:



- Serial number and pump type of the pump, (⇒ nameplate)
- Part number and description, (⇒ parts list)
- Quantity of spare parts
- Delivery address
- Shipping method

8. Faults; causes and remedies

 CAUTION	<p>Non-approved use</p> <p>Danger due to malfunctions in operation.</p> <ul style="list-style-type: none"> ✓ Observe the operating instructions of the pump and components of the pump unit. ✓ Operate the pump at the agreed operating point. ✓ Operate the pump according to the operating limits (⇒ section 4.2). ✓ Observe the agreed environmental conditions. ✓ Observe the specified properties of the pumped medium.
 CAUTION	<p>Liquid splashing out</p> <p>Danger to persons and the environment.</p> <ul style="list-style-type: none"> ✓ Wear suitable protective clothing. ✓ Check pump for leaks. ✓ Collect splashing sealing liquid suitably. ✓ Troubleshoot cause of leakage.

In particular, malfunctions which lead to leakage of the pump can – depending on the pumped medium – cause considerable damage to persons, the environment and the machine. These faults are specially marked.

Fault		Possible cause	Rectification
8.1 Pump does not pump even though motor is in operation	8.1.1	Pump not filled sufficiently before starting up.	Refill again and de-air.
	8.1.2	Suction tank empty or liquid level below inlet nozzle of suction line, therefore no liquid is flowing.	Install automatic monitoring device. Train personnel.
	8.1.3	Suction height too great leads to stall.	Position pump lower, and / or position liquid level higher.
	8.1.4	Pump sucking in additional air leads to stall.	Check suction pipe and shaft seal for leaks.
	8.1.5	Air sack formation in the pipes leads to stall.	Lay pipes correctly. Check position of armatures. If necessary fit de-airing devices. Install ventilation fittings if necessary.
	8.1.6	The overall delivery head is greater than that stated.	Adapt plant to suit pump or vice versa, otherwise use different pump.
	8.1.7	Impeller melted open in the hub region or has been destroyed due to faults as described in 8.6, 8.7.1–8.7.3 or 8.8.	Repair pump, check operational conditions, train personnel.
	8.1.8	Shaft broken in the pump.	Repair pump, check operational conditions, train personnel.
8.2 Flow and / or delivery head too low	8.2.1	Direction of rotation of pump is incorrect.	Change direction of rotation of motor to ensure pump rotates in the right direction. Check pump for damage before starting up again.
	8.2.2	Plant conditions do not agree with pump design.	Adapt plant to suit pump or vice versa, if necessary use a different pump.
	8.2.3	High pressure losses in unfavourably laid pipes.	Increase diameter of pipes and fittings. Create flow-favorable transitions. Avoid bends.
	8.2.4	Pipes or pump blocked.	Clean sieve, filter, pipes, fittings and pump.
	8.2.5	High pressure loss in suction pipe, therefore cavitation.	Clean suction basket or suction pipe, possibly increase diameter of suction pipe. Check foot valve to see if it opens fully.
	8.2.6	Suction height too great, therefore cavitation.	Position pump lower and / or position level of liquid higher.

Fault		Possible cause	Rectification
	8.2.7	Temperature of liquid to be pumped too high, therefore cavitation.	Reduce temperature of liquid to be pumped and / or increase suction pressure.
	8.2.8	High proportion of gas in liquid to be pumped.	Calm liquid to be pumped. Prevent liquid vortex using guide crosses. Lengthen circulation times. Make gassing out possible.
	8.2.9	Viscosity of liquid to be pumped higher than originally assumed.	Adapt pump, if necessary use a different pump. Alternative: Dilute or heat liquid to be pumped.
	8.2.10	Impeller worn due to abrasion.	Replace impeller.
8.3 Motor is overloaded	8.3.1	Pump cannot generate intended pressure due to system design. Actual operating point is reached at a higher flow than was intended with original design. This leads to increased power requirement.	Throttle valves on discharge side until intended pressure achieved. If no regulators have been fitted, pump must be adapted to suit actual system (Impeller correction, adjusting speed, install throttle bush).
	8.3.2	Only if speed regulation: no. of revs. too high.	Reduce no. of revs. Remove causes which led to increased speed (e.g. clean filter, remove deposits in pipes).
	8.3.3	Density of liquid to be pumped greater than originally assumed.	Fit motor with greater power.
	8.3.4	Viscosity of liquid to be pumped greater than originally assumed.	Fit motor with more power. Alternatively dilute liquid or preheat liquid to be pumped.
	8.3.5	Increased friction in double acting mechanical seal.	Check sealing pressure and reduce if possible. Otherwise check mechanical seal for wear or correct installation.
	8.3.6	Damage to pump. Therefore increased friction.	Repair pump.
8.4 WERNERT-Elastomere-bellows-mechanical seal leaks immediately after starting up 	8.4.1	WERNERT-Elastomere-bellows not tightened before starting up.	Tighten bellows according to ⇒ section 6.1.4 and Fig. 7.59.
8.5 Mechanical seal leaks after longer period of operation 	8.5.1	Rotating seal ring, stationary seal ring, bellows and / or seal elements worn, slightly damaged or attacked by chemicals.	Mechanical seals are wearing parts! Install spare parts. If necessary, plane surface on impeller for rotating seal ring (0.1 – 0.2 mm). If chemical attack, check material used.
	8.5.2	Pump not running evenly. Shaft banging.	Check shaft for roundness and check rolling bearings.

Fault		Possible cause	Rectification
<p>8.6 Single mechanical seal is destroyed spontaneously and is therefore leaking</p> 	8.6.1	The pump has run dry, i.e. there is no liquid in the entire pump. Hence the sliding faces overheat and they are thermally / mechanically destroyed plus frequently plastic parts nearby such as impeller and bellows are destroyed by the heat (so-called running hot).	Running dry is a typical operating error. The pump must be filled completely and de-aired before it is started up. Armatures on the suction side must be completely open. Train personnel accordingly. Repair pump.
	8.6.2	Semi- running -dry in case of stall, i.e. even though a liquid ring is rotating with the impeller, it does not reach the interior sliding faces. Therefore the seal runs hot.	Take measures to prevent flow being interrupted. Install automatic monitoring device. Train personnel. Repair pump. Equip single mechanical seal with continuous rinsing or if necessary equip with double acting mechanical seal.
	8.6.3	Due to increased gas particles in liquid being pumped, a gas ring is formed around the rotating and stationary seal rings. This gas is pressed through the sliding surfaces by the overatmospheric pressure in the pump. Therefore the seal runs hot.	Calm liquid to be pumped. Prevent liquid vortex using guide crosses. Lengthen circulation times. Make de-gassing possible. Repair pump. Equip single mechanical seal with continuous rinsing or if necessary equip with double acting mechanical seal.
	8.6.4	The liquid is virtually being pumped at boiling temperature. Due to the increase in temperature in the seal gap, due to friction and simultaneous decrease in pressure, the liquid being pumped evaporates in the seal gap. Possible crystals in the liquid might crystallize out. Therefore the seal runs hot.	Repair pump. Equip single mechanical seal with continuous rinsing or if necessary equip with double acting mechanical seal.
	8.6.5	High pressure losses on the suction side due to blockage or throttled valves cause a low pressure at the mechanical seal. Air is sucked from the atmosphere through the sliding surfaces. Seal runs hot.	Minimize losses on suction side. Train personnel accordingly. Repair pump. Possibly decrease diameter of impellers back-vanes. Equip single mechanical seal with quench or possibly equip with double acting mechanical seal.
	8.6.6	Due to pressure losses on the suction side due to increased flow with simultaneous pressure decrease at discharge nozzle causes low pressure in the area of the mechanical seal. Air is sucked from the atmosphere through the sliding areas. Seal runs hot.	Throttle valves on discharge side in order to get into the admissible operational range. Train personnel accordingly. Repair pump. Possibly decrease diameter of impellers back-vanes. Equip single mechanical seal with quench or possibly equip with double acting mechanical seal.

Fault		Possible cause	Rectification
8.7 Massive leaks 	8.7.1	Pump has been "dead headed", i.e. drive power is completely transformed into increased pump temperatures if liquid cannot be exchanged properly. This occurs if valves on pressure side remain closed after pump has been started up...	After starting up pump open valves on pressure side at least so far that the minimum pumping volume is achieved. Train personnel accordingly. If necessary equip with automatic device. Repair pump.
	8.7.2	or the pipe lines are blocked...	Clean pipelines, repair pump.
	8.7.3	or the static head of the system is not achieved by the pump.	Adapt plant to suit pump or vice versa, otherwise use different pump..
	8.7.4	Wear: the casing may be penetrated.	Worn parts must be replaced. Specify suitable intervals for checking and replacing parts.
	8.7.5	Chemical corrosion: cracks may form.	Check the chemical resistance of the parts in contact with the pumped liquid and replace any corroded parts. Specify suitable intervals for checking and replacing parts.
8.8 Pump is destroyed because it was rotating in wrong direction	8.8.1	Pump rotating in the wrong direction. (Impeller in contact with casing, impellers hub thread torn out, bearing cover destroyed, liquid no longer being pumped.)	Change poles on motor in order to achieve correct direction of rotation for the pump. Repair pump.
8.9 Increased bearing temperature	8.9.1	Motor aligned badly (Coupling halves are displaced in an axial, radial, angled direction).	Realign motor. The alignment has to be made according to the operating instructions of the coupling. Ensure axial coupling distance. For coupling type N-EUPEX® up to size 140 including applies: 5 – 6 mm. Size 160 ... 225: 6–7 mm
	8.9.2	Increased axial and / or radial forces because pump is being operated with flows which are too low or too high.	Operate the pump within the permissible operating range.
	8.9.3	Pump body is twisted by pipes.	Change position of pipes or position of pump to remove tension. Then align motor. Possibly position aggregate freely.
	8.9.4	Not sufficient, too much, used or unsuitable grease or oil.	Correct this situation.
	8.9.5	The lifespan of the radial ball bearings has been exceeded.	Replace radial ball bearings and observe intervals accordingly (⇒ section 7.2.3)
8.10 Uneven running (noises, vibrations)	8.10.1	Motor aligned badly (Coupling halves are displaced in an axial, radial, angled direction).	Realign motor. The alignment has to be made according to the operating instructions of the coupling. Ensure axial coupling distance. For coupling type N-EUPEX® up to size 140 including applies: 5 – 6 mm. Size 160 ... 225: 6–7 mm
	8.10.2	Flexible elements in the coupling worn out.	Replace flexible elements in the coupling.
	8.10.3	Bearing is damaged.	Replace roller bearings and shaft seal rings.
	8.10.4	Not fixed tightly to foundation.	Tighten fixing screws and anchors.

Fault		Possible cause	Rectification
	8.10.5	Cavitation	Take measure to avoid cavitation: <ul style="list-style-type: none"> - reduce flow being pumped - increase suction pressure - reduce losses on suction side
8.11 Leakage from the quench seal	8.11.1	Quench container insufficiently filled or frozen.	Repair quench seal, check mechanical seal. Select suitable quench medium. Specify suitable interval for inspection.
	8.11.2	Radial shaft seal ring 421.2 is damaged.	Replace radial seal shaft ring, check mechanical seal. Specify suitable interval for inspection / replacement.
8.12 Leakage from the double-acting mechanical seal	8.12.1	Pressure or amount of sealing liquid not set in accordance with operating instructions.	Check mechanical seal and replace damaged parts. Set suitable pressure and quantity for sealing liquid.
	8.12.2	Unsuitable sealing liquid.	Check mechanical seal and replace damaged parts. Select sealing liquid in accordance with ⇒ section 7.3.
	8.12.3	Vibrations	Check mechanical seal and replace damaged parts. Identify and eliminate cause of vibrations. Check alignment of motor in relation to pump and correct it if necessary.

9. Associated documentation

Each pump is supplied with these operating instructions.

Other documentation which describes the pump is not included in delivery as standard. The scope of the documentation to be delivered is agreed for each order separately.

10. Annex A: Name Plate

10.1 Design of the name plate

The design of the name plate is explained by means of code letters a - q.

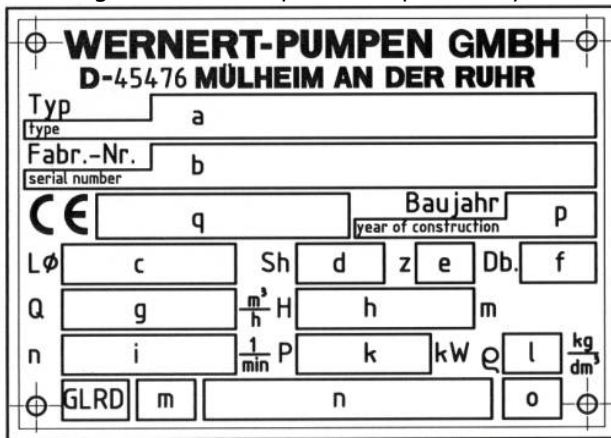

Figure A.1 Name plate with code letters

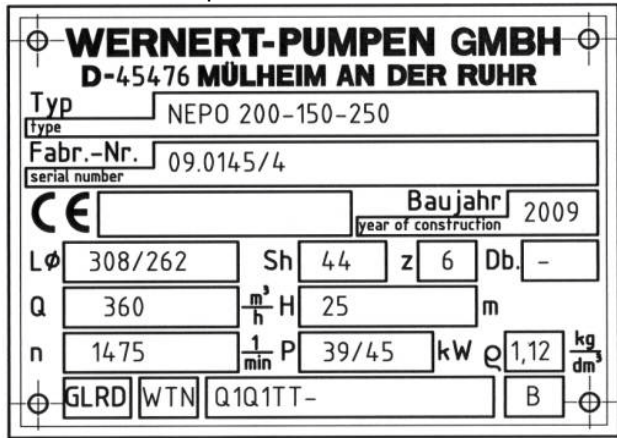

Figure A.2 Exemplary name plate

- Field a = Type designation
- Field b = WERNERT Serial number
- Field c = Impeller: Diameter (main-/back-vanes or front / main / back-vanes respectively) in mm
- Field d = Impeller: Blade height in mm
- Field e = Impeller: Number of blades
- Field f = If applicable throttling bush: Diameter in mm
- Field g = Nominal flow rate Q in m³/h
- Field h = Nominal delivery head H in m
- Field i = Nominal speed in 1/min
- Field k = Coupling power with density as per Field l / nominal drive power, each in kW
- Field l = Liquid density in kg/dm³
- Field m = WERNERT mechanical seal code (WGC), (⇒ section 10.2)
- Field n = Mechanical seal materials, product-side, (⇒ section 10.3)
- Field o = Material of the shaft sleeve, product-side, (⇒ section 10.3)
- Field p = Year of construction
- Field q = Weight of pump in kg

10.1.1 Additional name plate for pumps according to Directive 2014/34/EU/EC



Marking according to 2014/34/EU and EN ISO 80079-36:2016 and EN ISO 80079-37:2016:

II -/2G Ex h IIC T3 Gb or

II -/2G Ex h IIC T4 ... T3 Gb

II	-/	2G	Ex	h	IIC	T3	<p>Gb</p> <p>EPL=Equipment Protection Level</p> <p>Gb: Equipment with a <i>high level</i> of protection for use in potentially explosive atmospheres where there is no risk of ignition during normal operation or foreseeable faults/malfunctions.</p> <p>They may be used in Zone 1 (Category 2G).</p> <p>Gc: Device with <i>extended</i> protection level for use in hazardous areas. There is no ignition hazard during normal operation. The devices have some additional protective measures which ensure that there is no danger of ignition in case of usually foreseeable malfunctions of the device.</p> <p>They may be used in Zone 2 (Category 3G).</p> <p>If the actual maximum surface temperature does not depend on the device itself, but mainly on the operating conditions (such as a heated liquid in a pump), the manufacturer cannot label the device with a temperature class or temperature. In this case, the marking must include a reference to this situation with a T-range (e.g. T4 ... T3).</p> <p>Group II equipment is classified according to the type of explosive gas atmosphere for which it is intended. IIC, a typical gas is hydrogen.</p> <p>Non-electrical device for use in explosive atmospheres.</p> <p>A type of protection is not used for the letter "h".</p> <p>Ex symbol</p> <p>Category 2 includes equipment designed to operate in accordance with the parameters specified by the manufacturer and to ensure a high level of safety. Equipment in this category is intended for use in places where an explosive atmosphere of gases, vapours or mists is likely to occur occasionally. The explosion protection measures for equipment in this category ensure the required level of safety even in the event of frequent equipment malfunctions or faulty conditions which are usually to be expected.</p> <p>Category 3 includes equipment designed to be capable of being operated in accordance with the parameters specified by the manufacturer and to ensure a normal level of safety. Equipment in this category is intended for use in places where an explosive atmosphere is unlikely to be caused by gases, vapours, mists or swirling dust, but is likely to occur infrequently and for a short period of time. Equipment in this category ensures the required level of safety during normal operation.</p> <p>There is no zone inside the pump.</p> <p>Group II equipment is intended for use in places with explosive gas atmospheres, with the exception of mines endangered by mine gas and/or dust.</p>
----	----	----	----	---	-----	----	---

Additional type plate for T3

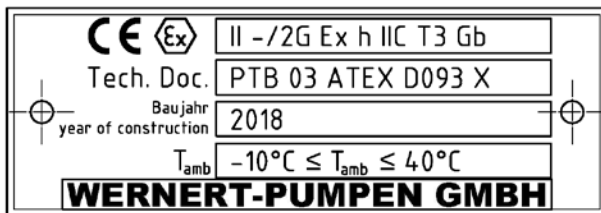

Additional type plate for T4

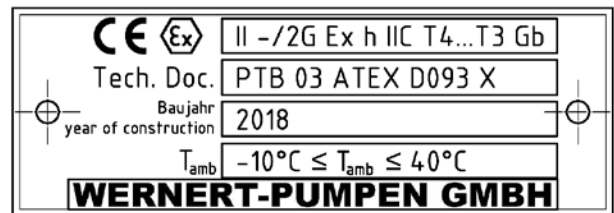

10.2 WERNERT mechanical seal code (WGC)

In the field m of the name plate, the design of the mechanical seal is entered by means of a code which always consists of three capital letters.

The first letter encrypts the general design:

- C = Cartridge sealing according to EN 12756, metal-free design within the liquid area
- D = Double seal according to EN 12756 (back-to-back), design K, shape UU
- E = Single-acting mechanical seal with stationary spring suspension and secondary O-ring seal
- F = Single-acting external mechanical seal with rotating PTFE bellows
- K = Single-acting mechanical seal with rotating tapered ring
- R = Single-acting mechanical seal with rotating spring suspension and secondary O-ring seal
- S = Stationary double seal
- W = WERNERT bellows-type mechanical seals
- X = Special design

The second letter encrypts the manufacturer of the mechanical seal:

- B = EagleBurgmann
- C = John Crane
- D = FLOWSERVE (Durametallic)
- E = WERNERT-EPDM bellows
- H = WERNERT-CSM bellows
- M = Merkel
- P = FLOWSERVE (Pacific)
- T = WERNERT-PTFE bellows
- V = WERNERT-FPM bellows

The third letter then distinguishes the special designs. More detailed information is available from the manufacturer.

The following codes apply to WERNERT bellows-type mechanical seals:

	WERNERT-EPDM bellows	WERNERT-FPM bellows	WERNERT-PTFE bellows	WERNERT-CSM bellows
Internal rinsing	WEN	WVN	WTN	WHN
Permanent rinsing	WED	WVD	WTD	WHD
Rinsing after use	WES	WVS	WTS	WHS
Quench	WEQ	WVQ	WTQ	WHQ
Quench, continuous rinsing	WEP	WVP	WTP	WHP
Quench, rinsing after use	WER	WVR	WTR	WHR
Stationary quench	WEA	WVA	WTA	WHA
Stationary quench, continuous rinsing	WEB	WVB	WTB	WHB
Stationary quench, rinsing after use	WEC	WVC	WTC	WHC
Special design	WEX	WVX	WTX	WHX

10.3 Mechanical seal materials

The mechanical seal materials are coded according to the material code in EN 12756, for double-acting mechanical seals, however, only the side facing the liquid to be pumped is mentioned. In field n, 5 materials must be indicated:

- 1st figure: Material of the spring-suspended seal ring
- 2nd figure: Material of the not spring-suspended seal ring
- 3rd figure: Material of the auxiliary gaskets (any additional material in parentheses)
- 4th figure: Material of the spring (if available)
- 5th figure: Material of the other structural parts

Field o: Material of the shaft sleeve

The following materials are used for WERNERT bellows-type mechanical seals:

1st/2nd figure:

- B = Carbon (synthetic-resin impregnated)
- C = Special carbon
- Q1 = SSiC (Silicon carbide, pressureless sintered)
- V = Aluminum oxide ceramics
- Y1 = PTFE, glass-reinforced
- Y2 = PTFE, carbon-reinforced

3rd figure:

- E = EPDM
- H = CSM
- T = PTFE
- V = FPM

4th figure:

- = Spring not available in case of WERNERT elastomer bellows
- T = 1.1200 / Halar® (other materials according to standard), in case of WERNERT PTFE bellows

5th figure:

- = Other structural parts not available

Field o :

- B = Carbon (synthetic-resin impregnated)
- C = Special carbon
- G = 1.4571
- M1 = Hastelloy® B
- M2 = Hastelloy® C
- Q1 = SSiC (Silicon carbide, pressureless sintered)
- Ti = Titanium
- V = Aluminum oxide ceramics

For further material identifications, please refer to Standard EN 12756.

11. Annex B: Admissible Nozzle Loads, Speeds

The admissible nozzle loads listed in Table B.1 are in line with API 610. The x axis is coaxial to the pump shaft, the y axis is the vertical line, and the z axis the horizontal line. The forces and moments listed can be taken up irrespective of their direction.

Type series NE	Size Bearing housing/ Max. speed	Vertical forces		Horizontal forces		Moments		
	Size [-] / speed [rpm]	Suction nozzle	Delivery nozzle	Suction nozzle	Delivery nozzle	Suction nz./ Delivery nz.	Suction nz./ Delivery nz.	Suction nz / Delivery nz.
Size of construction		Fy [N]	Fy [N]	Fx/Fz [N]	Fx/Fz [N]	Mx [Nm]	My [Nm]	Mz [Nm]
40-25-160	0 3600	±467	±601	±779/ ±579	±423/ ±334	±366/ ±203	±271/ ±149	±176/ ±81
50-32-160	1 3600	±579	±690	±890/ ±712	±512/ ±401	±461/ ±271	±353/ ±210	±230/ ±129
50-32-200	1 3600	±579	±690	±890/ ±712	±512/ ±401	±461/ ±271	±353/ ±210	±230/ ±129
50-32-250	2 3600	±579	±690	±890/ ±712	±512/ ±401	±461/ ±271	±353/ ±210	±230/ ±129
65-40-200	1 3600	±712	±779	±1113/ ±890	±579/ ±467	±705/ ±366	±664/ ±271	±353/ ±176
65-40-250	2 3600	±712	±779	±1113/ ±890	±579/ ±467	±705/ ±366	±664/ ±271	±353/ ±176
80-50-200	1 3600	±890	±890	±1335/ ±1068	±712/ ±579	±949/ ±461	±719/ ±353	±475/ ±230
80-50-250	2 3600	±890	±890	±1335/ ±1068	±712/ ±579	±949/ ±461	±719/ ±353	±475/ ±230
80-50-315	2 1750	±890	±890	±1335/ ±1068	±712/ ±579	±949/ ±461	±719/ ±353	±475/ ±230
100-65-250	2 3600	±1157	±1113	±1780/ ±1424	±890/ ±712	±1329/ ±705	±1003/ ±664	±678/ ±353
100-65-315	2 3600	±1157	±1113	±1780/ ±1424	±890/ ±712	±1329/ ±705	±1003/ ±664	±678/ ±353
125-80-200	2 3600	±1558	±1335	±2403/ ±1891	±1068/ ±890	±1763/ ±949	±1356/ ±719	±922/ ±475
125-80-250	2 3600	±1558	±1335	±2403/ ±1891	±1068/ ±890	±1763/ ±949	±1356/ ±719	±922/ ±475
125-80-315	3 1750	±1558	±1335	±2403/ ±1891	±1068/ ±890	±1763/ ±949	±1356/ ±719	±922/ ±475
125-100-200	2 3600	±1558	±1780	±2403/ ±1891	±1424/ ±1157	±1763/ ±1329	±1356/ ±1003	±922/ ±678
125-100-250	3 3000	±1558	±1780	±2403/ ±1891	±1424/ ±1157	±1763/ ±1329	±1356/ ±1003	±922/ ±678
125-100-315	3 1750	±1558	±1780	±2403/ ±1891	±1424/ ±1157	±1763/ ±1329	±1356/ ±1003	±922/ ±678
150-125-315	3 1750	±2047	±2403	±3115/ ±2492	±1891/ ±1558	±2305/ ±1763	±1763/ ±1356	±1180/ ±922
200-150-250	3 1750	±3115	±3115	±4895/ ±3783	±2492/ ±2047	±3525/ ±2305	±2576/ ±1763	±1763/ ±1180
200-150-400	4 1750	±3115	±3115	±4895/ ±3783	±2492/ ±2047	±3525/ ±2305	±2576/ ±1763	±1763/ ±1180
250-200-400	4 1750	±4450	±4895	±6675/ ±5340	±3783/ ±3115	±5016/ ±3525	±3796/ ±2576	±2440/ ±1763

Table B.1 Admissible nozzle loads and maximum speeds

12. Annex C: Tightening Torques

Thread size	Strength class	Tightening torque [Nm]	
		min.	max.
M4	8.8	1,7	2,8
M5	8.8	3,5	5,5
M6	8.8	6	9,5
M8	8.8	15	23
M10	8.8	30	46
M12	8.8	50	79
M14	8.8	90	125
M16	8.8	150	195
M18	8.8	225	280
M20	8.8	320	390
M22	8.8	440	530
M24	8.8	550	670
M27	8.8	810	1000
M30	8.8	1090	1350

Thread size	Strength class	Tightening torque [Nm]	
		min.	max.
M4	A2/A4 70	1,5	2
M5	A2/A4 70	2,5	3,5
M6	A2/A4 70	5	7
M8	A2/A4 70	9	14
M10	A2/A4 70	20	30
M12	A2/A4 70	33	50
M14	A2/A4 70	57	87
M16	A2/A4 70	84	120
M18	A2/A4 70	115	196
M20	A2/A4 70	190	275
M22	A2/A4 70	260	370
M24	A2/A4 70	330	476
M27	A2/A4 70	460	680
M30	A2/A4 70	650	930

Table C.1 Tightening torques for screw connections

Designation	Part-No.	Tightening torque [Nm]
Impeller Bearing housing size 0	233	20 Nm
Impeller Bearing housing size 1	233	80 Nm
Impeller Bearing housing size 2	233	195 Nm
Impeller Bearing housing size 3	233	300 Nm
Impeller Bearing housing size 4	233	300 Nm (Shaft nut)
Hexagon nut (Connecting screws on the pump flanges)	920.01, 920.02	≤ DN 125: approx. 35 Nm per screw DN 150 ... DN 250: approx. 70 Nm per screw
The following applies to the discharge variant:		
Cap	580.1	15 Nm
Hexagon nut (mounting flange, part 723)	920.08	15 Nm

Table C.2 Tightening torques

13. Annex D: Continuous flushing, weight

The recommended flushing quantity for continuous rinsing is listed in Table D.1. These data apply to all material pairings of the mechanical seal, however, except for SSiC/SSiC. For the material pairing SSiC/SSiC, half the flushing quantity of the values stated in the table must be considered. A tolerance of $\pm 10\%$ is admissible for the flushing quantity.

Type series NE	Rinsing quantity		Weight
	up to speed 1750 rpm	up to speed 3600 rpm	
Size of construction	[l/h]	[l/h]	Kg
40-25-160	40	60	40
50-32-160	70	120	60
50-32-200	70	120	75
50-32-250	100	140	100
65-40-200	70	120	70
65-40-250	100	140	100
80-50-200	70	120	80
80-50-250	100	140	110
80-50-315	100	-	140
NE_E 80-50-315	100	-	185
100-65-250	100	140	120
NE_E 100-65-315	100	140	185
125-80-200	100	140	120
125-80-250	100	140	150
125-80-315	120	-	220
125-100-200	100	140	140
125-100-250	120	160	170
125-100-315	120	-	220
150-125-315	120	-	330
200-150-250	120	-	310
200-150-400	250	-	450
250-200-400	250	-	740

Table D.1 Required flushing quantity for one or both parts of the mechanical seal of carbon, weight of pump