

EOM

ENGINEERING OPERATION
& MAINTENANCE

P4 Clamped Plastic Pump



Where Innovation Flows

WILDEN®

WIL-10160-E-10

Contents

Section 1: Precautions - Read First!	4
Section 2: Wilden Pump Designation System	5
Section 3: How It Works—Pump & Air Distribution System	6
Section 4: Dimensional Drawings	7
P4 Plastic	7
Section 5: Performance	8
P4 Plastic Rubber-Fitted.....	8
P4 Plastic TPE-Fitted.....	8
P4 Plastic Reduced-Stroke PTFE-Fitted.....	9
P4 Plastic Full-Stroke PTFE-Fitted.....	9
Suction-Lift Curves.....	10
Section 6: Suggested Installation, Operation, Maintenance and Troubleshooting	11
Section 7: Disassembly / Reassembly	14
Pump Disassembly.....	14
Air Valve / Center Section Disassembly.....	17
Reassembly Hints & Tips.....	19
PTFE Gasket Kit Installation.....	20
Section 8: Exploded View and Parts List	21
P4 Plastic Full-Stroke, 3-Piece Center-Section.....	21
P4 Plastic Reduced Stroke, 3-Piece Center-Section.....	23
Section 9: Elastomer Options	25

Copyright

Copyright 2018 PSG[®], a Dover Company. All rights reserved.

PSG reserves the right to modify the information and illustrations in this document without prior notice. The product described in this document is furnished under a license agreement or nondisclosure agreement. No part of this document may be reproduced, stored in a retrieval system, or transmitted in any form or any means electronic or mechanical, including photocopying and recording, without the written permission of PSG, a Dover Company, except as described by the terms of those agreements.

This is a non-contractual document. 01-2019.

Trademarks

PSG and the PSG logo are registered trademarks of PSG. Wilden[®] is a registered trademark of PSG California LLC. Pro-Flo[®] SHIFT and Pro-Flo[®] are registered trademarks of PSG California LLC. Wil-Flex[®] is a trademark of PSG California LLC. Saniflex[™] is a trademark of PSG California LLC.

All trademarks, names, logos and service marks (collectively "trademarks") in this document are registered and unregistered trademarks of their respective owners. Nothing contained in this document should be construed as granting any license or right to use any trademark without the prior written permission of the trademark owner.

Warranty

Each and every product manufactured by Wilden is built to meet the highest standards of quality. Every pump is functionally tested to insure integrity of operation. Wilden warrants that pumps, accessories and parts manufactured or supplied by it to be free from defects in material and workmanship for a period of five (5) years from date of installation or six (6) years from date of manufacture, whichever comes first.

For more information, and to register your Wilden pump for warranty, please visit <https://www.psgdover.com/wilden/support/warranty-registration>.

Certifications



Section 1

Precautions - Read First!

 **CAUTION:** Do not apply compressed air to the exhaust port — pump will not function.

 **CAUTION:** Do not over lubricate air supply — excess lubrication will reduce pump performance.

 **TEMPERATURE LIMITS*:**

Acetal	-29°C to 82°C	-20°F to 180°F
Buna-N	-12°C to 82°C	10°F to 180°F
Geolast®	-40°C to 82°C	-40°F to 180°F
Neoprene	-18°C to 93°C	0°F to 200°F
Nordel® EPDM	-51°C to 138°C	-60°F to 280°F
Nylon	-18°C to 93°C	0°F to 200°F
PFA	-7°C to 107°C	45°F to 225°F
Polypropylene	0°C to 79°C	32°F to 175°F
Polyurethane	-12°C to 66°C	10°F to 150°F
PVDF	-12°C to 107°C	10°F to 225°F
Saniflex™	-29°C to 104°C	-20°F to 220°F
SIPD PTFE with EPDM-backed	4°C to 137°C	40°F to 280°F
SIPD PTFE with Neoprene-backed	4°C to 93°C	40°F to 200°F
PTFE ¹	4°C to 104°C	40°F to 220°F
FKM	-40°C to 177°C	-40°F to 350°F
Wil-Flex™	-40°C to 107°C	-40°F to 225°F

14°C to 149°C (40°F to 300°F) - 13 mm (1/2") and 25 mm (1") models only.

NOTE: Not all materials are available for all models. Refer to Section 2 for material options for your pump.

 **CAUTION:** When choosing pump materials, be sure to check the temperature limits for all wetted components. Example: FKM has a maximum limit of 177°C (350°F) but polypropylene has a maximum limit of only 79°C (175°F).

 **CAUTION:** Maximum temperature limits are based upon mechanical stress only. Certain chemicals will significantly reduce maximum safe operating temperatures. Consult engineering guide for chemical compatibility and temperature limits.

 **CAUTION:** Always wear safety glasses when operating pump. If diaphragm rupture occurs, material being pumped may be forced out air exhaust. Plastic series pumps are made of virgin plastic and are not UV-stabilized. Direct sunlight for prolonged periods can cause deterioration of plastics.

 **WARNING:** Prevent static sparking — If static sparking occurs, fire or explosion could result. Pump, valves, and containers must be grounded when handling flammable fluids and whenever discharge of static electricity is a hazard. To ground the Wilden "Champ", all clamp bands must be grounded to a proper grounding point

 **CAUTION:** Do not exceed 8.6 bar (125 psig) air supply pressure.

 **CAUTION:** Before any maintenance or repair is attempted, the compressed air line to the pump should be disconnected and all air pressure allowed to bleed from pump. Disconnect all intake, discharge and air lines. Drain the pump by turning it upside down and allowing any fluid to flow into a suitable container.

 **CAUTION:** Blow out air line for 10 to 20 seconds before attaching to pump to make sure all pipeline debris is clear. Use an in-line air filter. **A 5µ (micron) air filter is recommended.**

 **NOTE:** When installing PTFE diaphragms, it is important to tighten outer pistons simultaneously (turning in opposite directions) to ensure tight fit.

 **NOTE:** P4 PVDF and PFA pumps come standard from the factory with expanded PTFE gaskets installed in the diaphragm bead of the liquid chamber, in the T-section and in the ball and seat area. PTFE gaskets cannot be re-used.

 **NOTE:** Before starting disassembly, mark a line from each liquid chamber to its corresponding air chamber. This line will assist in proper alignment during reassembly.

 **CAUTION:** The P4 plastic pump is not submersible.

 **CAUTION:** Pumps should be flushed thoroughly with water before installation into process line.

 **CAUTION:** Tighten all hardware prior to installation.

Section 2

WILDEN PUMP DESIGNATION SYSTEM

P4 PLASTIC

25 mm (1") Pump
Maximum Flow Rate:
140 lpm (37 gpm)

LEGEND

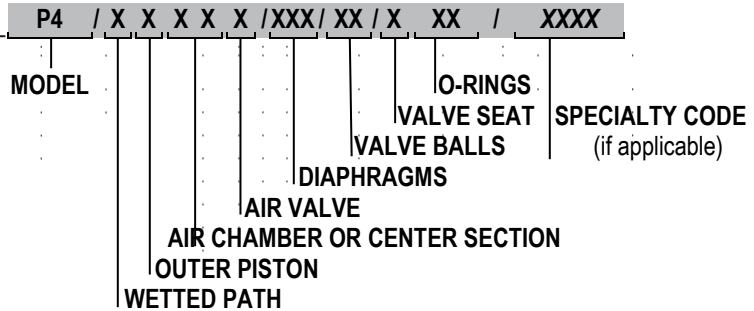

MATERIAL CODES

<p>MODEL P4 = PRO-FLO®</p> <p>WETTED PATH K = PVDF P = POLYPROPYLENE</p> <p>OUTER PISTON K = PVDF P = POLYPROPYLENE</p> <p>AIR CHAMBER/ CENTER SECTION A = ALUMINUM C = PTFE-COATED ALUMINUM L = ACETAL S = STAINLESS STEEL V = HALAR®-COATED ALUMINUM</p> <p>AIR VALVE L = ACETAL P = POLYPROPYLENE</p>	<p>DIAPHRAGMS BNS = BUNA-N (Red Dot) BNU = BUNA-N, ULTRA-FLEX™ (Red Dot) EPS = EPDM (Blue Dot) EPU = EPDM, ULTRA-FLEX™ (Blue Dot) FSS = SANIFLEX™ [Hytrel® (Cream)] NES = NEOPRENE (Green Dot) NEU = NEOPRENE, ULTRA-FLEX™ (Green Dot) PUS = POLYURETHANE (Clear) TEU = PTFE W/EPDM BACK-UP (White) TSS = FULL-STROKE PTFE W/SANIFLEX™ BACKUP TSU = PTFE W/SANIFLEX™ BACKUP (White) TWS = FULL-STROKE PTFE W/WIL-FLEX™ BACKUP VTS = FKM (White Dot) VTU = FKM, ULTRA-FLEX™ WFS = WIL-FLEX™ [Santoprene® (Three Black Dots)]</p>	<p>VALVE BALLS BN = BUNA-N (Red Dot) EP = EPDM (Blue Dot) FS = SANIFLEX™ [Hytrel® (Cream)] FV = SANITARY FKM (Two White Dots) NE = NEOPRENE (Green Dot) PU = POLYURETHANE (Brown) TF = PTFE (White) VT = FKM (White Dot) WF = WIL-FLEX™ [Santoprene® (Three Black Dots)]</p> <p>VALVE SEATS K = PVDF P = POLYPROPYLENE T = PFA</p> <p>VALVE SEAT O-RING BN = BUNA-N PU = POLYURETHANE (Brown) TV = PTFE ENCAP. FKM</p>
---	--	---

SPECIALTY CODES

0100 Wil-Gard II™ 110V	0513 SS outer pistons	0612 Ultrapure, PFA-coated hardware, male connections
0102 Wil-Gard II™ sensor wires ONLY	0560 Split manifold	0618 Ultrapure, PFA-coated hardware, Wil-Gard II™ 110V, male connections
0103 Wil-Gard II™ 220V	0561 Split manifold, PFA-coated hardware	0622 Ultrapure, male connections
0206 PFA-coated hardware, Wil-Gard II™ sensor wires ONLY	0563 Split manifold, discharge ONLY	0624 Ultrapure, Wil-Gard II™ 110V, male connections
0502 PFA-coated hardware	0564 Split manifold, inlet ONLY	0660 Split manifold, Wil-Gard II™ 110V
0504 DIN flange	0603 PFA-coated hardware, Wil-Gard II™ 110V	0661 Split manifold PFA-coated hardware, Wil-Gard II™ 110V
0506 DIN flange, PFA-coated hardware	0604 DIN flange, Wil-Gard II™ 220V	
0512 Adapter block, no muffler, Pro-Flo®, center section	0606 DIN flange, PFA-coated hardware, Wil-Gard II™ 220V	
	0608 PFA-coated hardware, Wil-Gard II™ 220V	

NOTE: Most Elastomeric materials use colored dots for identification.

NOTE: Not all models are available with all material options.

Halar® is a registered trademark of Solvay.

Hytrel® is a registered trademark of DuPont Dow Elastomers.

Section 3

HOW IT WORKS — PUMP

The Wilden diaphragm pump is an air-operated, placement, self-priming pump. These drawings show the flow pattern through the pump upon its initial stroke. It is assumed the pump has no fluid in it prior to its initial stroke.

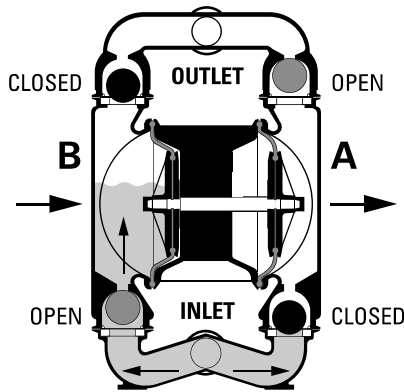

FIGURE 1 The air valve directs pressurized air to the back side of diaphragm A. The compressed air is applied directly to the liquid column separated by elastomeric diaphragms. The diaphragm acts as a separation membrane between the compressed air and liquid, balancing the load and removing mechanical stress from the diaphragm. The compressed air moves the diaphragm away from the center block of the pump. The opposite diaphragm is pulled in by the shaft connected to the pressurized diaphragm. Diaphragm B is on its suction stroke; air behind the diaphragm has been forced out to the atmosphere through the exhaust port of the pump. The movement of diaphragm B toward the center block of the pump creates a vacuum within chamber B. Atmospheric pressure forces fluid into the inlet manifold forcing the inlet valve ball off its seat. Liquid is free to move past the inlet valve ball and fill the liquid chamber (see shaded area).

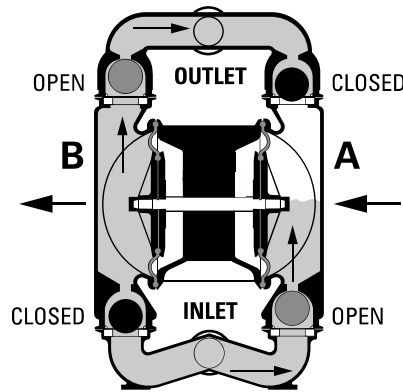

FIGURE 2 When the pressurized diaphragm, diaphragm A, reaches the limit of its discharge stroke, the air valve redirects pressurized air to the back side of diaphragm B. The pressurized air forces diaphragm B away from the center block while pulling diaphragm A to the center block. Diaphragm B is now on its discharge stroke. Diaphragm B forces the inlet valve ball onto its seat due to the hydraulic forces developed in the liquid chamber and manifold of the pump. These same hydraulic forces lift the discharge valve ball off its seat, while the opposite discharge valve ball is forced onto its seat, forcing fluid to flow through the pump discharge. The movement of diaphragm A toward the center block of the pump creates a vacuum within liquid chamber A. Atmospheric pressure forces fluid into the inlet manifold of the pump. The inlet valve ball is forced off its seat allowing the fluid being pumped to fill the liquid chamber.

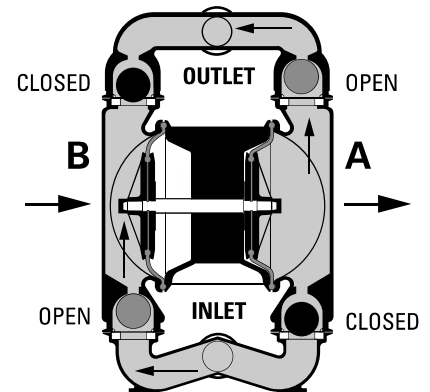
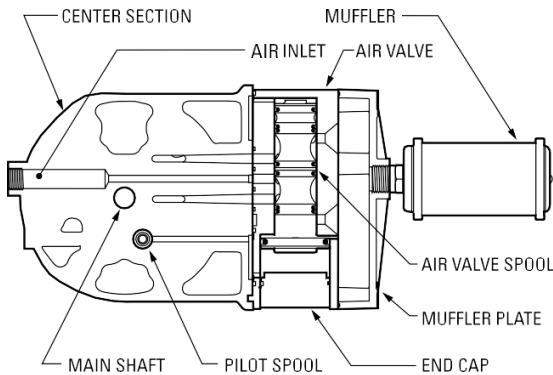

FIGURE 3 At completion of the stroke, the air valve again redirects air to the back side of diaphragm A, which starts diaphragm B on its exhaust stroke. As the pump reaches its original starting point, each diaphragm has gone through one exhaust and one discharge stroke. This constitutes one complete pumping cycle. The pump may take several cycles to completely prime depending on the conditions of the application.

HOW IT WORKS— AIR DISTRIBUTION SYSTEM



The Pro-Flo® patented air distribution system incorporates two moving parts: the air valve spool and the pilot spool. The heart of the system is the air valve spool and air valve. This valve design incorporates an unbalanced spool. The smaller end of the spool is pressurized continuously, while the large end is alternately pressurized then exhausted to move the spool. The spool directs pressurized air to one air chamber while exhausting the other. The air causes the main shaft/diaphragm assembly to shift to one side — discharging liquid on that side and pulling liquid in on the other side. When the shaft reaches the end of its stroke, the inner piston actuates the pilot spool, which pressurizes and exhausts the large end of the air valve spool. The repositioning of the air valve spool routes the air to the other air chamber.

DIMENSIONAL DRAWING

P4 Plastic

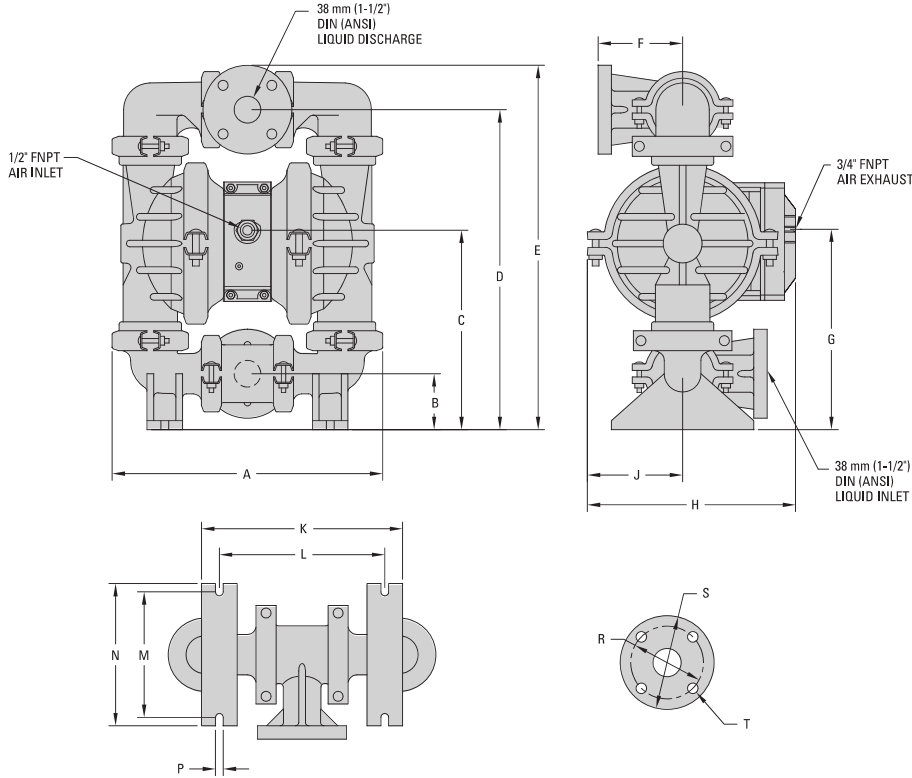

DIMENSIONS

ITEM	METRIC (mm)	STANDARD (inch)
A	394	15.5
B	79	3.1
C	287	11.3
D	465	18.3
E	528	20.8
F	122	4.8
G	287	11.3
H	300	11.8
J	137	5.4
K	287	11.3
L	236	9.3
M	180	7.1
N	203	8.0
P	10	0.4
DIN FLANGE		
R	109 DIA.	4.3 DIA.
S	150 DIA.	5.9 DIA.
T	18 DIA.	0.7 DIA.
ANSI FLANGE		
R	99 DIA.	3.9 DIA.
S	127 DIA.	5.0 DIA.
T	20 DIA.	0.8 DIA.

LW0496 REV.A

Section 5

PERFORMANCE

P4 PLASTIC RUBBER-FITTED

Ship Weight.... Polypropylene 16.8 kg (37 lb)
PVDF 21.3 kg (47 lb)
Air Inlet..... 13 mm (1/2")
Inlet..... 38 mm (1-1/2")
Outlet..... 38 mm (1-1/2")
Suction Lift..... 4.88 m Dry (16')
7.92 m Wet (26')
Disp. Per Stroke¹..... 1.19 L (0.314 gal)
Max. Flow Rate..... 348 lpm (92 gpm)
Max. Size Solids..... 4.8 mm (3/16")

¹Displacement per stroke was calculated at 4.8 bar (70 psig) air inlet pressure against a 2 bar (30 psig) head pressure.

Example: To pump 159 lpm (40 gpm) against a discharge pressure head of 2.7 bar (40 psig) requires 4.1 bar (60 psig) and 30.6 Nm³/h (18 scfm) air consumption. (See dot on chart.)

Caution: Do not exceed 8.6 bar (125 psig) air supply pressure.

BAR FEET PSIG

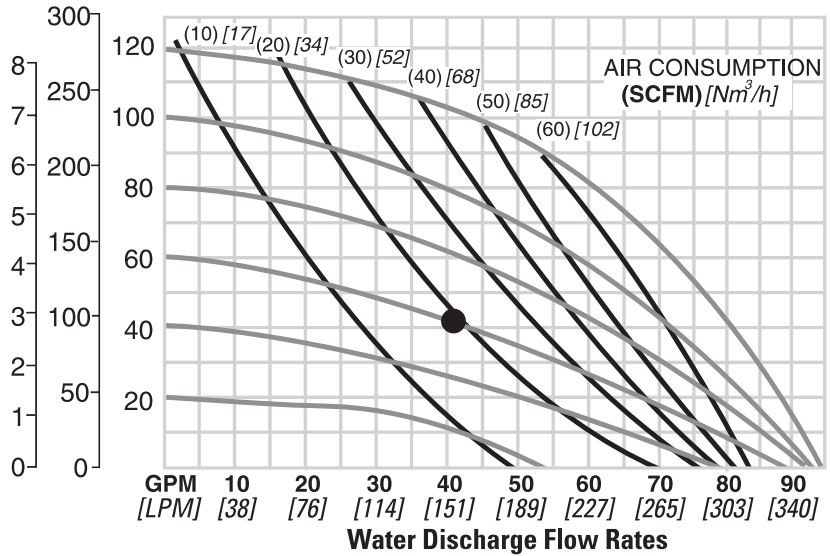

Flow rates indicated on chart were determined by pumping water.

For optimum life and performance, pumps should be specified so that daily operation parameters will fall in the center of the pump's performance curve.

P4 PLASTIC TPE-FITTED

Ship Weight.... Polypropylene 16.8 kg (37 lb)
PVDF 21.3 kg (47 lb)
Air Inlet..... 13 mm (1/2")
Inlet..... 38 mm (1-1/2")
Outlet..... 38 mm (1-1/2")
Suction Lift..... 3.96 m Dry (13')
7.92 m Wet (26')
Disp. Per Stroke¹..... 1.18 L (0.311 gal)
Max. Flow Rate..... 354 lpm (94 gpm)
Max. Size Solids..... 4.8 mm (3/16")

¹Displacement per stroke was calculated at 4.8 bar (70 psig) air inlet pressure against a 2 bar (30 psig) head pressure.

Example: To pump 42 gpm (159 lpm) against a discharge pressure head of 2.7 bar (40 psig) requires 4.1 bar (60 psig) and 34 Nm³/h (20 scfm) air consumption. (See dot on chart.)

Caution: Do not exceed 8.6 bar (125 psig) air supply pressure.

BAR FEET PSIG

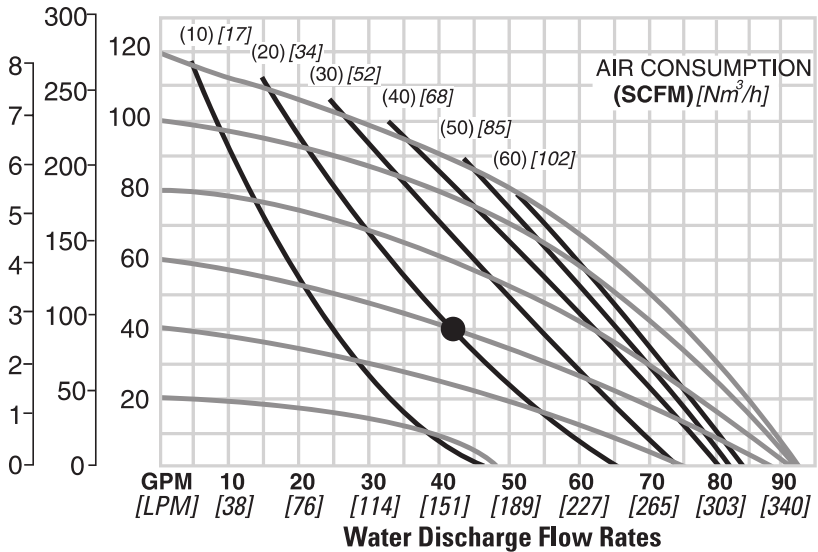

Flow rates indicated on chart were determined by pumping water.

For optimum life and performance, pumps should be specified so that daily operation parameters will fall in the center of the pump's performance curve.

PERFORMANCE

P4 PLASTIC REDUCED-STROKE PTFE-FITTED

Ship Weight.... Polypropylene 16.8 kg (37 lb)
PVDF 21.3 kg (47 lb)
Air Inlet..... 13 mm (1/2")
Inlet..... 38 mm (1-1/2")
Outlet 38 mm (1-1/2")
Suction Lift 3.05 m Dry (10' Dry)
7.47 m Wet (24.5')
Disp. Per Stroke¹ 0.53 L (0.139 gal)
Max. Flow Rate..... 261 lpm (69 gpm)
Max. Size Solids..... 4.8 mm (3/16")

¹Displacement per stroke was calculated at 4.8 bar (70 psig) air inlet pressure against a 2 bar (30 psig) head pressure.

Example: To pump 125 lpm (33 gpm) against a discharge pressure head of 2.7 bar (40 psig) requires 4 bar (58 psig) and 45 Nm³/h (27 scfm) air consumption. (See dot on chart.)

Caution: Do not exceed 8.6 bar (125 psig) air supply pressure.

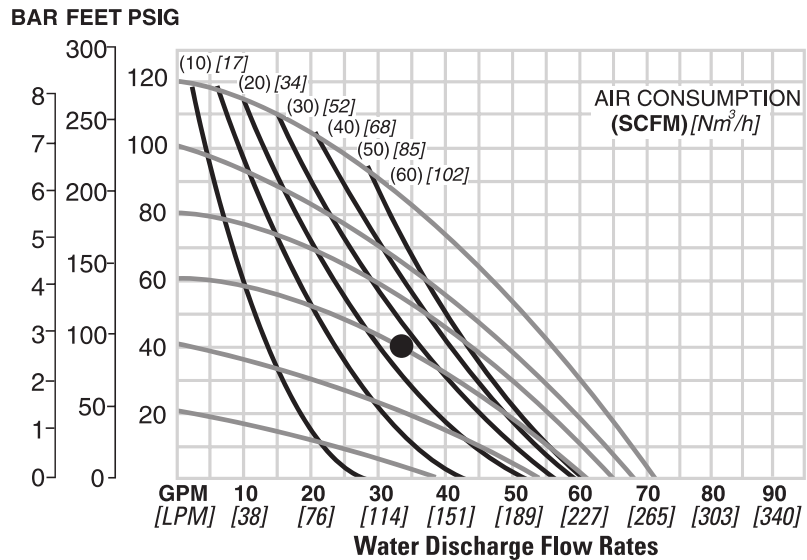

Flow rates indicated on chart were determined by pumping water.

For optimum life and performance, pumps should be specified so that daily operation parameters will fall in the center of the pump's performance curve.

P4 PLASTIC FULL-STROKE PTFE-FITTED

Ship Weight.... Polypropylene 16.8 kg (37 lb)
PVDF 21.3 kg (47 lb)
PTFE PFA 23.9 kg (52 lb)
Air Inlet..... 13 mm (1/2")
Inlet..... 38 mm (1-1/2")
Outlet 38 mm (1-1/2")
Suction Lift 4.7m Dry (15.3')
.9.3 m Wet (30.6')
Disp. Per Stroke¹ 1.0 L (.27 gal)
Max. Flow Rate..... 352 lpm (92.9 gpm)
Max. Size Solids..... 4.8 mm (3/16")

¹Displacement per stroke was calculated at 4.8 bar (70 psig) air inlet pressure against a 2.1 bar (30 psig) head pressure..

Example: To pump 288 lpm (76 gpm) against a discharge head of 2.1 bar (30 psig) requires 6.9 bar (100 psig) and 158 Nm³/hr air consumption.

Caution: Do not exceed 8.6 bar (125 psig) air supply pressure.

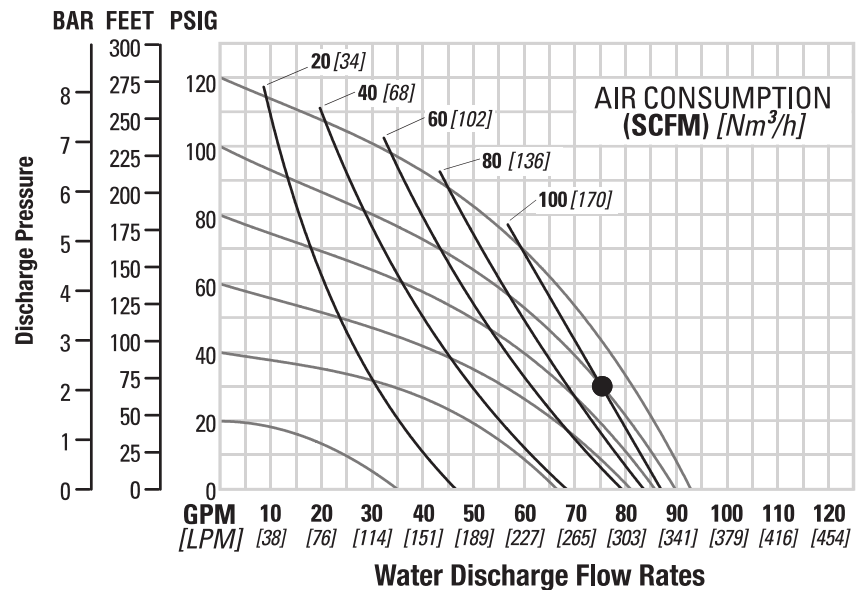

Flow rates indicated on chart were determined by pumping water.

For optimum life and performance, pumps should be specified so that daily operation parameters will fall in the center of the pump's performance curve.

SUCTION LIFT CURVES

P4 PLASTIC SUCTION - LIFT CAPABILITY

Suction-lift curves are calibrated for pumps operating at 305 m (1,000') above sea level. This chart is meant to be a guide only. There are many variables which can affect your pump's operating characteristics. The number of intake and discharge elbows, viscosity of pumping fluid, elevation (atmospheric pressure) and pipe friction loss all affect the amount of suction lift your pump will attain

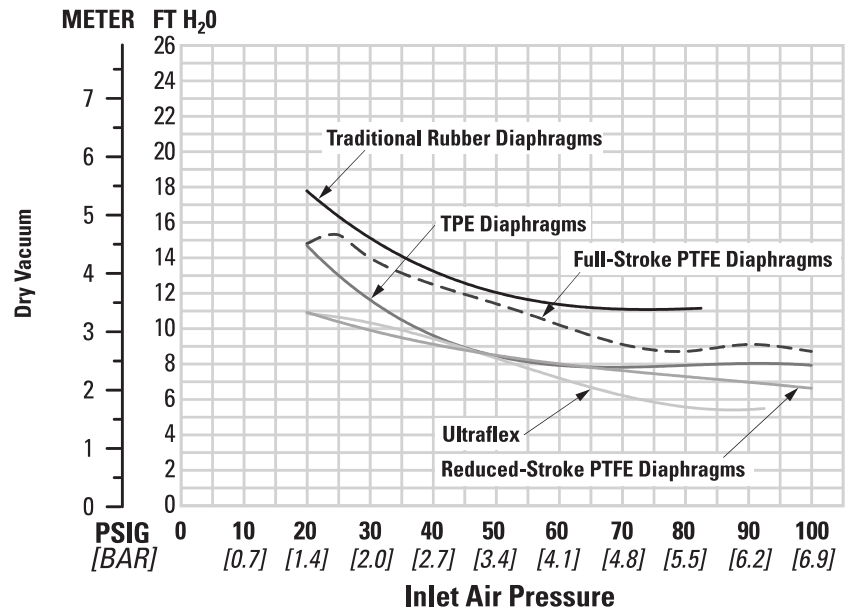

Section 6

Suggested Installation, Operation, Maintenance and Troubleshooting

The P4 pump has a 38 mm (1-1/2") inlet and 38 mm (1-1/2") outlet and is designed for flows to 354 lpm (94 gpm). The P4 Plastic pump is manufactured with wetted parts of pure, unpigmented, PTFE or polypropylene. The P4 Plastic is constructed with a polypropylene center block. A variety of diaphragms and O-rings are available to satisfy temperature, chemical compatibility, abrasion and flex concerns.

The suction pipe size should be at least 38 mm (1-1/2") diameter or larger if highly viscous material is being pumped. The suction hose must be non-collapsible, reinforced type as the P4 is capable of pulling a high vacuum. Discharge piping should be at least 38 mm (1-1/2"); larger diameter can be used to reduce friction losses. It is critical that all fittings and connections are airtight or a reduction or loss of pump suction capability will result.

For P4 Plastic models, Wilden offers 150 lb standard and metric flanges. The following details should be noted when mating these to pipe works:

- A 60–80 shore gasket that covers the entire flange face should be used.
- The gasket should be between 1.91 mm (0.075") and 4.45 mm (0.175") thickness.
- Mating flanges with flat as opposed to raised surfaces should be used for proper mechanical sealing.
- The flanges should be tightened to a minimum of 6.8 N•m (5 ft-lb) but no more than 13.5 N•m (10 ft-lb).



CAUTION: All fittings and connections must be airtight. Otherwise, pump suction capability will be reduced or lost.

Months of careful planning, study and selection efforts can result in unsatisfactory pump performance if installation details are left to chance. You can avoid premature failure and long-term dissatisfaction by exercising reasonable care throughout the installation process.

Location

Noise, safety and other logistical factors usually dictate where equipment will be situated on the production floor. Multiple installations with conflicting requirements can result in congestion of utility areas, leaving few choices for additional pumps.

Within the framework of these and other existing conditions, every pump should be located in such a way that several key factors are balanced against each other to maximum advantage.

- **Access:** First of all, the location should be accessible. If it's easy to reach the pump, maintenance personnel will have an easier time carrying out routine inspections and adjustments. Should major repairs become necessary, ease of access can play a key role in speeding the repair process and reducing total downtime.
- **Air Supply:** Every pump location should have an air line large enough to supply the volume of air necessary to achieve the desired pumping rate. Use air pressure up to a maximum of 8.6 bar (125 psig) depending on pumping requirements.

For best results, the pumps should use a 5µ (micron) air filter, needle valve and regulator. The use of an air filter before the pump will ensure that the majority of any pipeline contaminants will be eliminated.

- **Solenoid Operation:** When operation is controlled by a solenoid valve in the air line, three-way valves should be used. This valve allows trapped air between the valve and the pump to bleed off which improves pump performance. Pumping volume can be estimated by counting the number of strokes per minute and then multiplying the figure by the displacement per stroke.

- **Muffler:** Sound levels are reduced below OSHA specifications using the standard Wilden muffler. Other mufflers can be used to further reduce sound levels, but they usually reduce pump performance.
- **Elevation:** Selecting a site that is well within the pump's dynamic-lift capability will assure that loss-of-prime issues will be eliminated. In addition, pump efficiency can be adversely affected if proper attention is not given to site location.
- **Piping:** Final determination of the pump site should not be made until the piping challenges of each possible location have been evaluated. The impact of current and future installations should be considered ahead of time to make sure that inadvertent restrictions are not created for any remaining sites.

The best choice possible will be a site involving the shortest and straightest hook-up of suction and discharge piping. Unnecessary elbows, bends and fittings should be avoided. Pipe sizes should be selected to keep friction losses within practical limits. All piping should be supported independently of the pump. In addition, the piping should be aligned to avoid placing stress on the pump fittings.

Flexible hose can be installed to aid in absorbing the forces created by the natural reciprocating action of the pump. If the pump is to be bolted down to a solid location, a mounting pad placed between the pump and the foundation will assist in minimizing pump vibration. Flexible connections between the pump and rigid piping will also assist in minimizing pump vibration. If quick-closing valves are installed at any point in the discharge system, or if pulsation within a system becomes a problem, a surge suppressor (SD Equalizer®) should be installed to protect the pump, piping and gauges from surges and water hammer.



NOTE: Materials of construction and elastomer material have an effect on suction-lift parameters. Please refer to the performance section for specifics.

When pumps are installed in applications involving flooded suction or suction-head pressures, a gate valve should be installed in the suction line to permit closing of the line for pump service.

For P4 Plastic models, a non-raised surfaced-flange adapter should be utilized when mating to the pump's inlet and discharge manifolds for proper sealing.

If the pump is to be used in a self-priming application, be sure that all connections are airtight and that the suction lift is within the model's ability. Note: Materials of construction and elastomer material have an effect on suction lift parameters. Please consult Wilden distributors for specifics.

Pumps in service with a positive suction head are most efficient when inlet pressure is limited to 0.5–0.7 bar (7–10 psig). Premature diaphragm failure may occur if positive suction is 0.7 bar (10 psig) and higher.

The model P4 champ will pass 0.5 mm (3/16") solids. Whenever the possibility exists that larger solid objects may be sucked into the pump, a strainer should be used on the suction line



CAUTION: Do not exceed 8.6 bar (125 psig) air supply pressure.

P4 pumps cannot be submerged. For submerged applications, use a wilden T4 pump.

Suggested Installation, Operation, Maintenance and Troubleshooting

This illustration is a generic representation of an air-operated double-diaphragm pump.

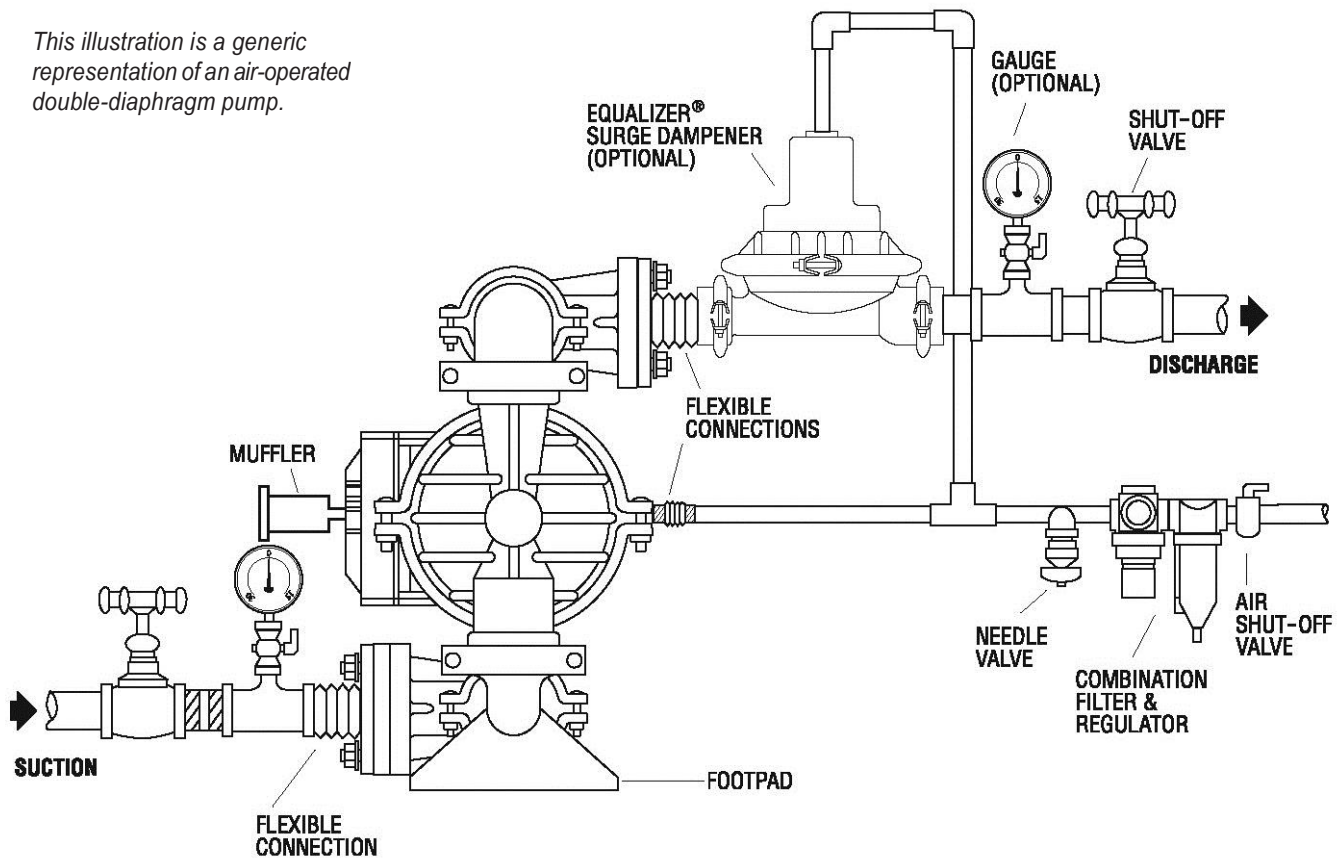

NOTE: In the event of a power failure, the shut-off valve should be closed, if the restarting of the pump is not desirable once power is regained.

Air-Operated Pumps: To stop the pump from operating in an emergency situation, simply close the shut-off valve (user-supplied) installed in the air supply line. A properly functioning valve will stop the air supply to the pump, therefore stopping output. This shut-off valve should be located far enough away from the pumping equipment such that it can be reached safely in an emergency situation

Operation

The P4 pump is pre-lubricated, and does not require in-line lubrication. Additional lubrication will not damage the pump, however if the pump is heavily lubricated by an external source, the pump's internal lubrication may be washed away. If the pump is then moved to a non-lubricated location, it may need to be disassembled and re-lubricated as described in the **DISASSEMBLY / REASSEMBLY INSTRUCTIONS**.

Pump discharge rate can be controlled by limiting the volume and/or pressure of the air supply to the pump. An air regulator is used to regulate air pressure. A needle valve is used to regulate volume. Pump discharge rate can also be controlled by throttling the pump

discharge by partially closing a valve in the discharge line of the pump. This action increases friction loss which reduces flow rate. (See Section 5.) This is useful when the need exists to control the pump from a remote location. When the pump discharge pressure equals or exceeds the air supply pressure, the pump will stop; no bypass or pressure relief valve is needed, and pump damage will not occur. The pump has reached a "deadhead" situation and can be restarted by reducing the fluid discharge pressure or increasing the air inlet pressure. Wilden Pro-Flo® SHIFT pumps run solely on compressed air and do not generate heat; therefore, your process fluid temperature will not be affected.

Maintenance and Inspections

Since each application is unique, maintenance schedules may be different for every pump. Frequency of use, line pressure, viscosity and abrasiveness of process fluid all affect the parts life of a Wilden pump. Periodic inspections have been found to offer the best means for preventing unscheduled pump downtime. Personnel familiar with the pump's construction and service should be informed of any abnormalities that are detected during operation.

Suggested Installation, Operation, Maintenance and Troubleshooting

Troubleshooting

Pump will not run or runs slowly.

1. Ensure that the air inlet pressure is at least 0.3 bar (5psig) above start up pressure and that the differential pressure (the difference between air inlet and liquid discharge pressures) is not less than 0.7 bar (10psig).
2. Check air inlet filter for debris (see SUGGESTED INSTALLATION).
3. Check for extreme air leakage (blow by) that would indicate worn seals/bores in the air valve, pilot spool and main shaft.
4. Disassemble pump and check for obstructions in the air passageways or objects that would obstruct the movement of internal parts.
5. Check for sticking ball check valves. If material being pumped is not compatible with pump elastomers, swelling may occur. Replace ball check valves and seals with proper elastomers. Also, as the check valve balls wear out, they become smaller and can become stuck in the seats. In this case, replace balls and seats.
6. Check for broken inner piston that will cause the air valve spool to be unable to shift.
7. Remove plug from pilot spool exhaust.

Pump runs but little or no product flows.

1. Check for pump cavitation; slow pump speed down to allow thick material to flow into liquid chambers.
2. Verify that vacuum required to lift liquid is not greater than the vapor pressure of the material being pumped (cavitation).

3. Verify that vacuum required to lift liquid is not greater than the vapor pressure of the material being pumped (cavitation).
4. Check for sticking ball check valves. If material being pumped is not compatible with pump elastomers, swelling may occur. Replace ball check valves and seats with proper elastomers. Also, as the check valve balls wear out, they become smaller and can become stuck in the seats. In this case, replace balls and seats.

Pump air valve freezes.

1. Check for excessive moisture in compressed air. Either install a dryer or hot-air generator for compressed air. Alternatively, a coalescing filter may be used to remove the water from the compressed air in some applications.

Air bubbles in pump discharge.

1. Check for ruptured diaphragm.
2. Check tightness of outer pistons (refer to Section 7).
3. Check tightness of fasteners and integrity of O-rings and seals, especially at intake manifold.
4. Ensure pipe connections are airtight.

Product comes out air exhaust.

1. Check for diaphragm rupture.
2. Check tightness of outer pistons to shaft.

Section 7

Disassembly / Reassembly

Pump Disassembly

Tools Required:

- 1/2" Wrench
- Adjustable Wrench
- Vise equipped with soft jaws (such as plywood, plastic or other suitable material)



CAUTION: Before any maintenance or repair is attempted, the compressed air line to the pump should be disconnected and all air pressure allowed to bleed from the pump. Disconnect all intake, discharge, and air lines. Drain the pump by turning it upside down and allowing any fluid to flow into a suitable container. Be aware of any hazardous effects of contact with your process fluid.

The Wilden P4 has a 38 mm (1-1/2") inlet and outlet and is designed for flows up to 354 lpm (94 gpm). Its air distribution system is based on a revolutionary design which increases reliability and performance. The model P4 is available in injection molded polypropylene, PTFE PFA and PVDF wetted parts.

PLEASE read all directions before starting disassembly.



NOTE: The model used for these instructions incorporates rubber diaphragms, balls, and seats. Models with PTFE diaphragms, balls and seats are the same except where noted.



NOTE: Replace worn parts with genuine Wilden parts for reliable performance.



Step 1

Before starting disassembly, mark a line from each liquid chamber to its corresponding air chamber. This line will assist in proper alignment during reassembly.



Step 2

Utilizing a 1/2" wrench, remove the two small clamp bands that fasten the discharge manifold to the liquid chambers.

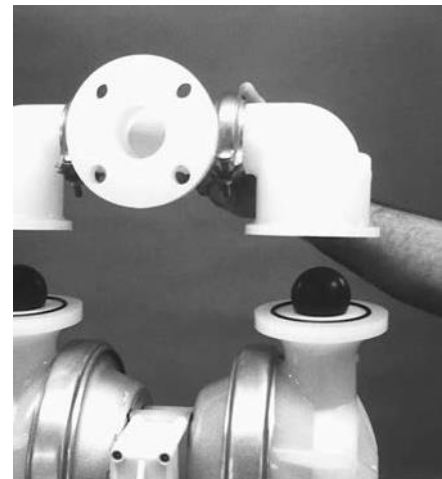

Step 3

Remove the discharge manifold to expose the valve balls and seats. Inspect ball cage area of manifold for excessive wear or damage.

Disassembly / Reassembly



Step 4

Remove the discharge valve balls and seats from the liquid chambers and inspect for nicks, gouges, chemical attack or abrasive wear. Replace worn parts with genuine Wilden parts for reliable performance.



Step 5

Remove the two small clamp bands which fasten the intake manifold to the liquid chambers.

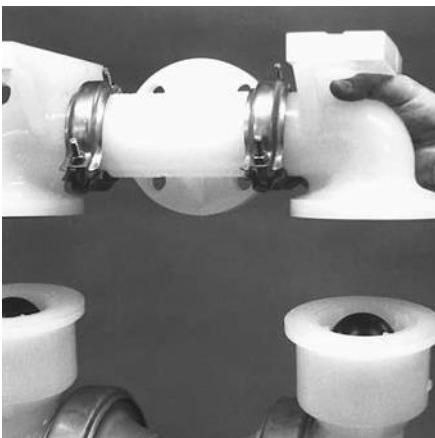

Step 6

Lift intake manifold from liquid chambers and center section to expose intake valve balls and seats. Inspect ball cage area of liquid chambers for excessive wear or damage.



Step 7

Remove valve seats and valve balls for inspection. Replace if necessary.

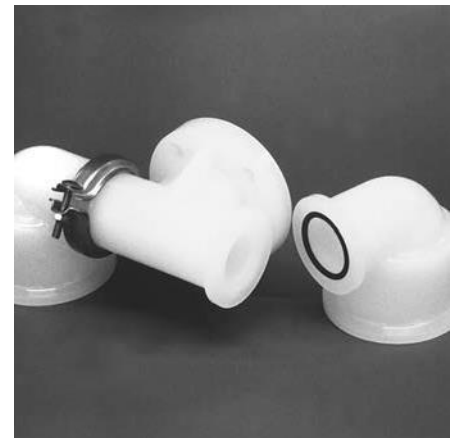

Step 8

Remove small manifold clamp bands to inspect manifold O-rings.

Disassembly / Reassembly



Step 9

Remove one set of large clamp bands which secure one liquid chamber to the center section.



Step 10

Lift liquid chamber away from center section to expose diaphragm and outer piston.



Step 11

Using an adjustable wrench, or by rotating the diaphragm by hand, remove the diaphragm assembly.



Step 12

Figure 12



Figure 13

NOTE: Due to varying torque values, one of the following two situations may occur:
 1) The outer piston, diaphragm and inner piston remain attached to the shaft and the entire assembly can be removed from the center section (Figure 12).
 2) The outer piston, diaphragm and inner piston separate from the shaft which remains connected to the opposite side diaphragm assembly (Figure 13). Repeat disassembly instructions for the opposite liquid chamber. Inspect diaphragm assembly and shaft for signs of wear or chemical attack. Replace all worn parts with genuine Wilden parts for reliable performance.



Step 13

Remove tee section from liquid chamber and inspect O-rings for signs of wear. Replace worn parts with genuine Wilden parts for reliable performance.

Disassembly / Reassembly

Air Valve / Center Section Disassembly

Tools Required:

- 3/16" Hex-Head Wrench
- 1/4" Hex-Head Wrench
- Snap-Ring Pliers
- O-Ring Pick



CAUTION: Before any maintenance or repair is attempted, the compressed air line to the pump should be disconnected and all air pressure allowed to bleed from the pump. Disconnect all intake, discharge, and air lines. Drain the pump by turning it upside down and allowing any fluid to flow into a suitable container. Be aware of hazardous effects of contact with your process fluid.

The Wilden P4 plastic pump utilizes a revolutionary Pro-Flo® air distribution system. A 13 mm (1/2") air inlet connects the air supply to the center section. Proprietary composite seals reduce the coefficient of friction and allow the P4 to run lube-free. The Pro-Flo® air distribution system is designed to perform in on/off, non-freezing, non-stalling, tough duty applications.



NOTE: Replace worn parts with genuine Wilden parts for reliable performance.



Step 1

Loosen the air valve bolts utilizing a 3/16" hex-head wrench and then remove muffer plate screws.

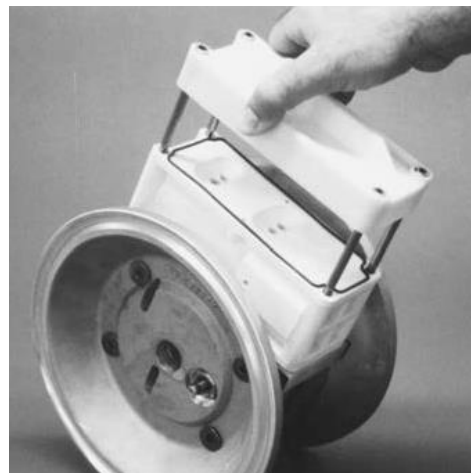

Step 2

Remove muffer plate and air valve bolts from air valve assembly exposing muffer gasket for inspection. Replace if necessary.

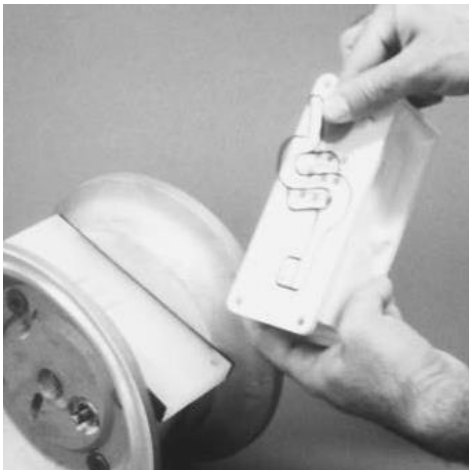

Step 3

Lift away air valve assembly and remove air valve gasket for inspection. Replace if necessary.



Step 4

Remove air valve end cap to expose air valve spool by simply lifting up on end cap once air valve bolts are removed

Disassembly / Reassembly



Step 5

Remove air valve spool from air valve body by threading one air valve bolt into the end of the spool and gently sliding the spool out of the air valve body. Inspect seals for signs of wear and replace entire assembly if necessary. Use caution when handling air valve spool to prevent damaging seals.



NOTE: Seals should not be removed from assembly. Seals are not sold separately.

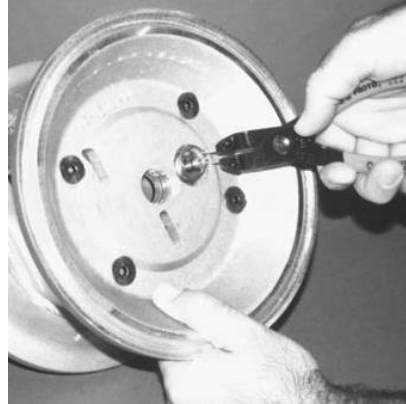

Step 6

Remove pilot spool retaining snap ring on both sides of center section with snap-ring pliers.



Step 7

Remove air chamber bolts with 1/4" hex-head wrench.



Step 8

Remove pilot spool bushing from center block.

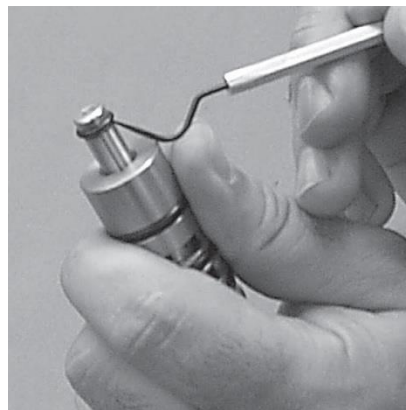

Step 9

With O-ring pick, gently remove the o-ring from the opposite side of the "center hole" cut on the spool. Gently remove the pilot spool from sleeve and inspect for nicks or gouges and other signs of wear. Replace pilot sleeve assembly or outer sleeve O-rings if necessary. During re-assembly never insert the pilot spool into the sleeve with the "center cut" side first, this end incorporates the urethane o-ring and will be damaged as it slides over the ports cut in the sleeve.



NOTE: Seals should not be removed from pilot spool. Seals are not sold separately.

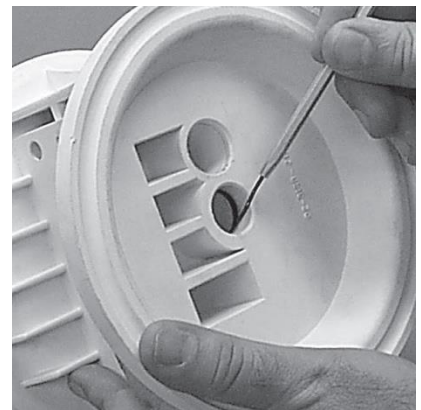

Step 10

Figure 10

Check center block Glyd™ rings for signs of wear. If necessary, remove Glyd™ rings with O-ring pick and replace.



NOTE: Threaded sleeves (see A — Figure 10) are removable and can be replaced if necessary. Sleeves can be press fit by hand.

Disassembly / Reassembly

Reassembly Hints & Tips

Upon performing applicable maintenance to the air distribution system, the pump can now be reassembled. Please refer to the disassembly instructions for photos and parts placement. To reassemble the pump, follow the disassembly instructions in reverse order. The air distribution system needs to be assembled first, then the diaphragms and finally the wetted path. Please find the applicable torque specifications on this page.

The following tips will assist in the assembly process.

- Lubricate air valve bore, center section shaft and pilot spool bore with NLGI grade 2 white EP bearing grease or equivalent.
- Clean the inside of the center section shaft bushing to ensure no damage is done to new Glyd™ ring seals.
- A small amount of NLGI grade 2 white EP bearing grease can be applied to the muffler and air valve gaskets to locate gaskets during assembly.
- Make sure that the exhaust port on the muffler plate is centered between the two exhaust ports on the center section.
- Stainless bolts should be lubed to reduce the possibility of seizing during tightening.
- Use a mallet to tamp lightly on the large clamp bands to seat the diaphragm before tightening.

GLYD™ RING INSTALLATION:

PRE-INSTALLATION

- Use a mallet to tamp lightly on the large clamp bands to seat the diaphragm before tightening.
- Once all of the old seals have been removed, the inside of the bushing should be cleaned to ensure no debris is left that may cause premature damage to the new seals.

PRO-FLO MAXIMUM TORQUE SPECIFICATIONS

Description of Part	Torque
Air Valve	5.1 N•m (45 in-lb)
Outer Piston	47.5 N•m (35 ft-lb)
Small Clamp Band	9.6 N•m (85 in-lb)
Large Clamp Band (Rubber-Fitted)	18.6 N•m (165 in-lb)
Large Clamp Band (PTFE-Fitted)	18.6 N•m (165 in-lb)
Air Chamber Screws (HSFHS 3/8"-16)	47.5 N•m (35 ft-lb)

Figure A

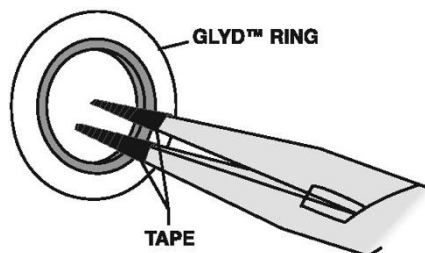

INSTALLATION

The following tools can be used to aid in the installation of the new seals:

- Needle-Nose Pliers
- Phillips Screwdriver
- Electrical Tape
- Wrap electrical tape around each leg of the needle-nose pliers (heat shrink tubing may also be used). This is done to prevent damaging the inside surface of the new seal.
- With a new seal in hand, place the two legs of the needle-nose pliers inside the seal ring. (See Figure A.)
- Open the pliers as wide as the seal diameter will allow, then with two fingers pull down on the top portion of the seal to form a kidney shape. (See Figure B.)
- Lightly clamp the pliers together to hold the seal into the kidney shape. Be sure to pull the seal into as tight of a kidney shape as possible, this will allow the seal to travel down the bushing bore easier.
- With the seal clamped in the pliers, insert the seal into the bushing bore and position the bottom of the seal into the correct groove. Once the bottom of the seal is seated in the groove, release the clamp pressure on the pliers. This will allow the seal to partially snap back to its original shape.
- After the pliers are removed, you will notice a slight bump in the seal shape. Before the seal can be properly resized, the bump in the seal should be removed as much as possible. This can be done with either the Phillips screwdriver or your finger. With either the side of the screwdriver or your finger, apply light pressure to the peak of the bump. This pressure will cause the bump to be almost completely eliminated.
- Lubricate the edge of the shaft with NLGI grade 2 white EP bearing grease.
- Slowly insert the center shaft with a rotating motion. This will complete the resizing of the seal.
- Perform these steps for the remaining seal.

Figure B

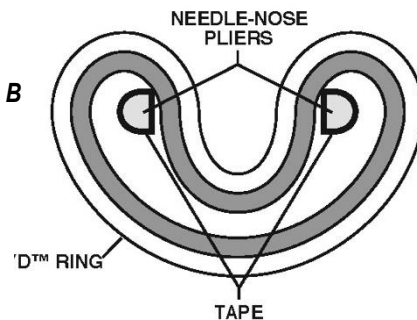

Gasket Kit / Installation

P1 PVDF and Ultrapure pumps come standard with expanded PTFE Gasket Kits (P/N 01-9501-99) for all sealing surfaces. P1 Poly pumps come standard with expanded PTFE Gasket Kits (P/N 01-9500-99) for diaphragm bead only.

Carefully prepare sealing surfaces by removing all debris and foreign matter from diaphragm bead and all mating surfaces. If necessary, smooth or deburr all sealing surfaces. Mating surfaces must be properly aligned in order to ensure positive sealing characteristics.

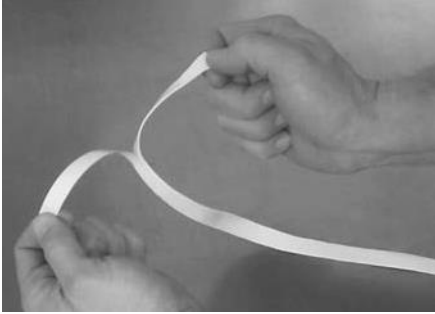

Step 1

Gently remove the adhesive covering from the back of the PTFE tape. Ensure that the adhesive strip remains attached to the PTFE tape and is not removed with the adhesive covering.



Step 2

Starting at any point, place the PTFE tape directly on top of the diaphragm bead. Press lightly on the tape to ensure that the adhesive holds it in place during assembly. Do not stretch the tape during placement on the diaphragm bead.



Step 3

The end of the tape should overlap approximately 13 mm (1/2"). Proceed to install the PTFE tape on the remaining diaphragm.



Step 4

Carefully remove the protective covering from the back of the PTFE gasket attached to tape.



Step 5

Install the valve ball, valve seat and o-ring.



Step 6

Center the gasket so that it evenly covers the o-ring and seat areas.



Step 7

Gently apply pressure to gasket to ensure the adhesive maintains a positive seal to stay in place during pump assembly.

Section 8

Exploded View and Parts Listing

P4 PLASTIC

FULL-STROKE/3-PIECE CENTER-SECTION

EXPLODED VIEW

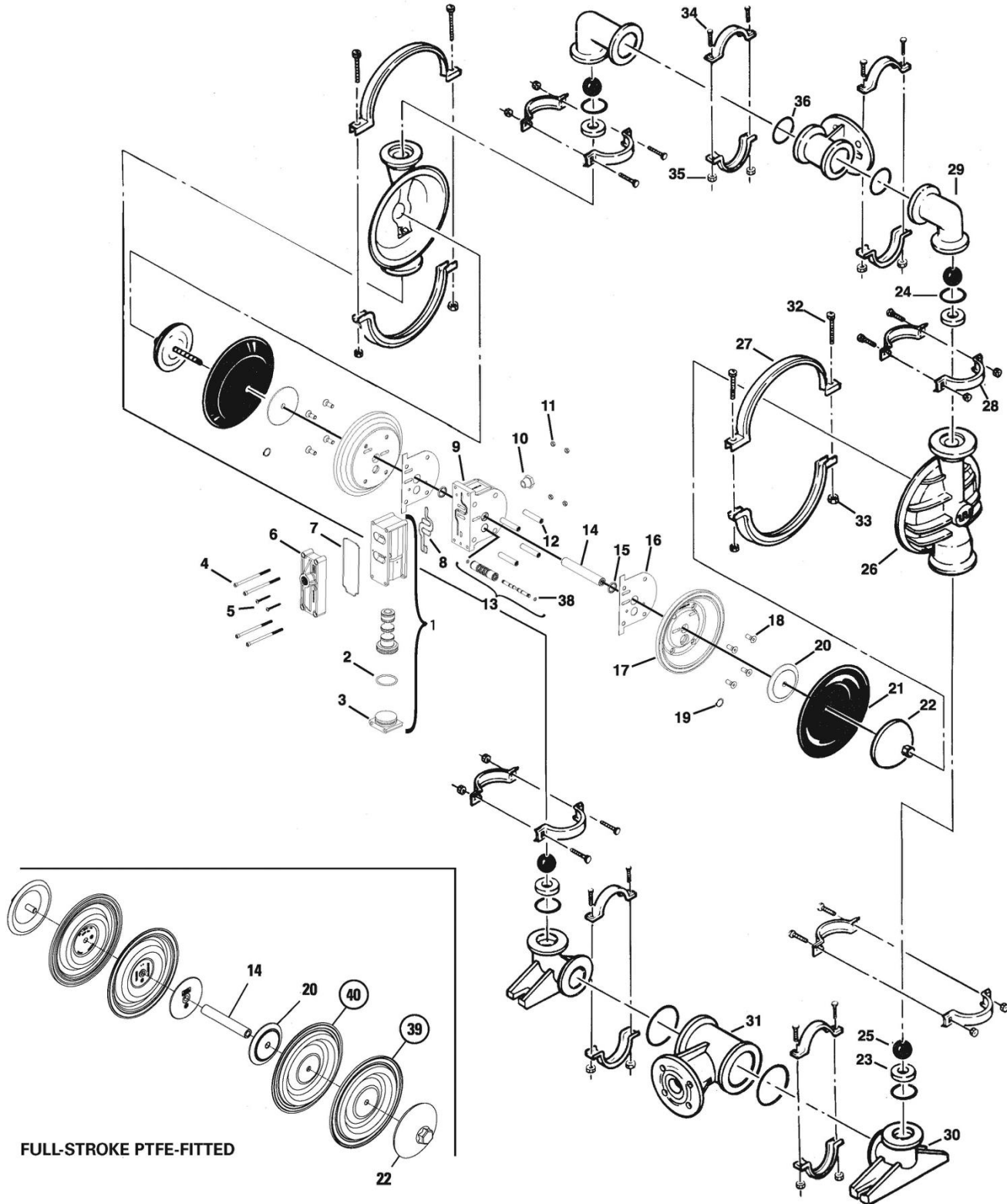

Exploded View and Parts List

No.	Part Description	Qty.	P4/PPAPP P/N	P4/KKAPP P/N	P4/PPCPP/0502 P/N	P4/KKCPP/0502 P/N
1	Pro-Flo® Air Valve Assembly¹	1	04-2000-20-700	04-2000-20-700	04-2000-20-700	04-2000-20-700
2	O-Ring (-225), End Cap (1.859" x .139")	1	04-2390-52-700	04-2390-52-700	04-2390-52-700	04-2390-52-700
3	End Cap, Pro-Flo®	1	04-2330-20-700	04-2330-20-700	04-2330-20-700	04-2330-20-700
4	Screw, HHC, Air Valve (1/4" x 4.5")	4	01-6000-03	01-6000-03	01-6000-05	01-6000-05
5	Screw, SHCS, 10-16 x 1 3/4"	2	04-6351-03	04-6351-03	04-6351-05	04-6351-05
6	Muffler Plate, Pro-Flo®	1	04-3180-20-700	04-3180-20-700	04-3180-20-700	04-3180-20-700
7	Gasket, Muffler Plate	1	04-3500-52-700	04-3500-52-700	04-3500-52-700	04-3500-52-700
8	Gasket, Air Valve	1	04-2600-52-700	04-2600-52-700	04-2600-52-700	04-2600-52-700
9	Center Block Assembly	1	04-3110-20	04-3110-20	04-3110-20	04-3110-20
10	Bushing, Reducer, NPT/BSP Combo	1	04-6950-20-700	04-6950-20-700	04-6950-20-700	04-6950-20-700
11	Nut, Square, 1/4"-20	4	00-6505-03	00-6505-03	00-6505-05	00-6505-05
12	Sleeve, Threaded, Pro-Flo® Center Block	4	04-7710-08	04-7710-08	04-7710-08	04-7710-08
13	Removable Pilot Sleeve Assembly	1	04-3880-99	04-3880-99	04-3880-99	04-3880-99
14	Shaft, Pro-Flo®	1	04-3800-03-700	04-3800-03-700	04-3800-03-700	04-3800-03-700
15	Glyd™ Ring	2	08-3210-55-225	08-3210-55-225	08-3210-55-225	08-3210-55-225
16	Gasket, Center Block, Pro-Flo®	2	04-3526-52	04-3526-52	04-3526-52	04-3526-52
17	Air Chamber, Pro-Flo®	2	04-3651-01	04-3651-01	04-3651-05	04-3651-05
18	Screw, HSFHS, 3/8"-16 x 1"	8	71-6250-08	71-6250-08	71-6250-08	71-6250-08
19	Retaining Ring	2	04-3890-03	04-3890-03	04-3890-03	04-3890-03
20	Inner Piston	2	04-3700-01-700	04-3700-01-700	04-3700-01-700	04-3700-01-700
21	Diaphragm	2	*	*	*	*
22	Outer Piston	2	04-4550-20-500	04-4550-21-500	04-4550-20-500	04-4550-21-500
23	Valve Seat	4	04-1120-20-500	04-1120-21-500	04-1120-20-500	04-1120-21-500
24	Valve Seat, O-Ring (2.609" x .139")	4	*	*	*	*
25	Valve Ball	4	*	*	*	*
26	Chamber, Liquid	2	04-5000-20	04-5000-21	04-5000-20	04-5000-21
27	Large Clamp Band Assy.	2	04-7300-03-500	04-7300-03-500	04-7300-05-500	04-7300-05-500
28	Small Clamp Band Assy.	8	04-7100-03-500	04-7100-03-500	04-7100-05-500	04-7100-05-500
29	Manifold, Discharge Elbow	2	04-5230-20	04-5230-21	04-5230-20	04-5230-21
30	Manifold, Inlet Elbow	2	04-5220-20	04-5220-21	04-5220-20	04-5220-21
31	Manifold, Tee Section	2	04-5160-20	04-5160-21	04-5160-20	04-5160-21
32	Carriage Bolt, Large Clamp Band (5/16"-18RHSN)	4	04-6070-03	04-6070-03	04-6070-05	04-6070-05
33	Hex Nut, Large Clamp Band (5/16"-18)	4	08-6400-03	08-6400-03	08-6400-05	08-6400-05
34	Carriage Bolt, Small Clamp Band (1/4"-20 RHSN)	16	08-6050-03-500	08-6050-03-500	08-6050-05-500	08-6050-05-500
35	Hex Nut, Small Clamp Band (1/4"-20)	16	08-6400-03	08-6400-03	08-6400-05	08-6400-05
36	Tee Section O-Ring (2.734" x .139")	4	*	*	*	*
37	Muffler (Not shown)	1	04-3510-99	04-3510-99	04-3510-99	04-3510-99
38	Pilot Spool Retaining O-Ring	2	04-2650-49-700	04-2650-49-700	04-2650-49-700	04-2650-49-700
39	Diaphragm, Full Stroke PTFE, Primary	2	04-1040-55	04-1040-55	04-1040-55	04-1040-55
40	Diaphragm, Full Stroke PTFE, Back-Up	2	*	*	*	*

¹Air Valve Assembly includes item numbers 2 and 3.
DIN Flange: Polypropylene = P/N 04-5160-20-504 PVDF = P/N 04-5160-21-504
0502 Specialty Code = PFA-Coated Hardware
*Refer to elastomer chart in Section 10.
All boldface items are primary wear parts.

Exploded View and Parts Listing

P4 PLASTIC

REDUCED-STROKE/3-PIECE CENTER-SECTION

EXPLODED VIEW

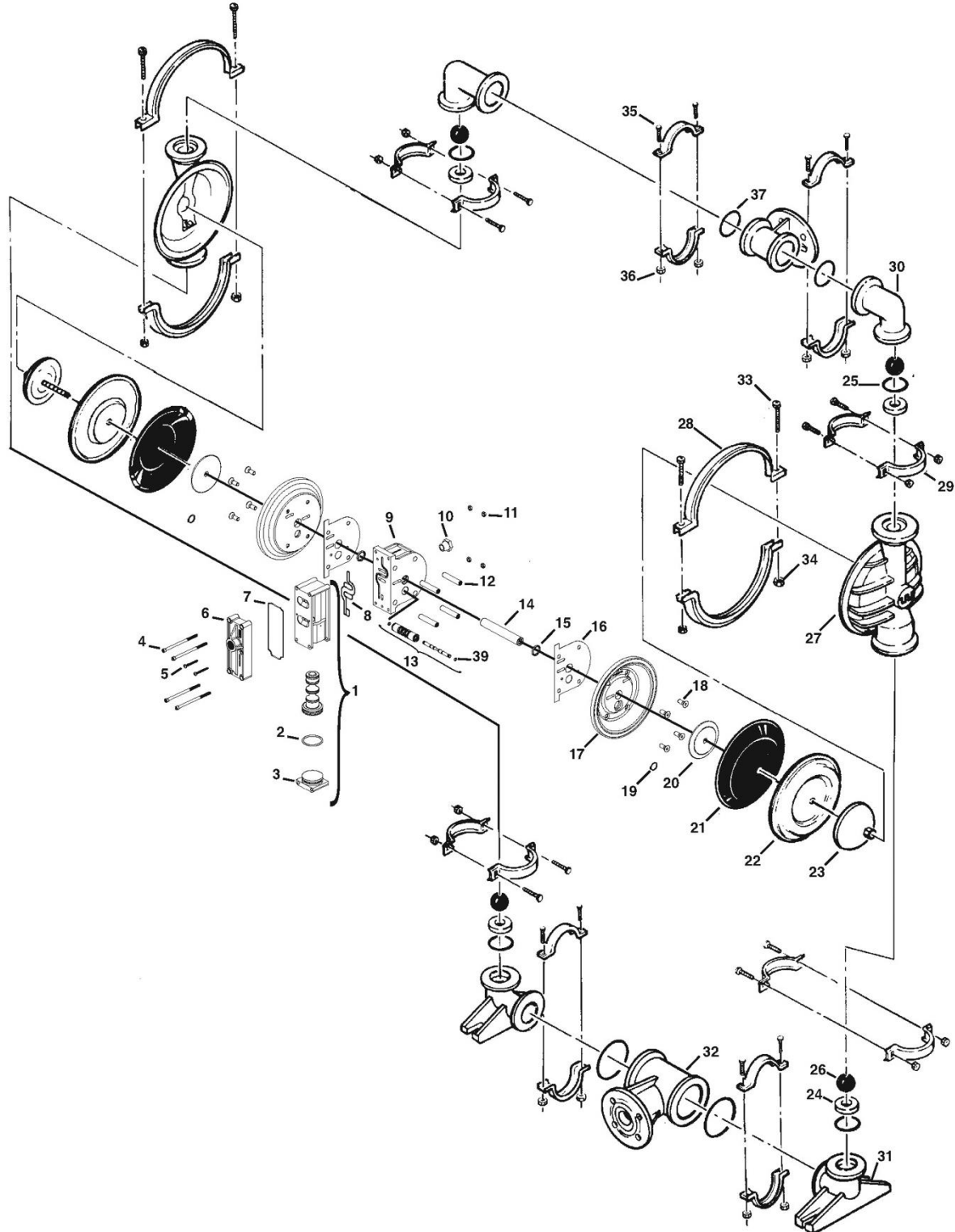

Exploded View and Parts List

No.	Part Description	Qty.	P4/PPAPP P/N	P4/KKAPP P/N	P4/PPCPP/0502 P/N	P4/KKCPP/0502 P/N
1	Pro-Flo® Air Valve Assembly*	1	04-2000-20-700	04-2000-20-700	04-2000-20-700	04-2000-20-700
2	O-Ring (-225), End Cap (1.859" x .139")	1	04-2390-52-700	04-2390-52-700	04-2390-52-700	04-2390-52-700
3	End Cap, Pro-Flo®	1	04-2330-20-700	04-2330-20-700	04-2330-20-700	04-2330-20-700
4	Screw, HHC, Air Valve (1/4" x 4.5")	4	01-6000-03	01-6000-03	01-6000-05	01-6000-05
5	Screw, SHCS, 10-16 x 1 3/4"	2	04-6351-03	04-6351-03	04-6351-05	04-6351-05
6	Muffler Plate, Pro-Flo®	1	04-3180-20-700	04-3180-20-700	04-3180-20-700	04-3180-20-700
7	Gasket, Muffler Plate	1	04-3500-52-700	04-3500-52-700	04-3500-52-700	04-3500-52-700
8	Gasket, Air Valve	1	04-2600-52-700	04-2600-52-700	04-2600-52-700	04-2600-52-700
9	Center Block Assembly	1	04-3110-20	04-3110-20	04-3110-20	04-3110-20
10	Bushing, Reducer, NPT/BSP Combo	1	04-6950-20-700	04-6950-20-700	04-6950-20-700	04-6950-20-700
11	Nut, Square, 1/4"-20	4	00-6505-03	00-6505-03	00-6505-03	00-6505-03
12	Sleeve, Threaded, Pro-Flo® Center Block	4	04-7710-08	04-7710-08	04-7710-08	04-7710-08
13	Removable Pilot Sleeve Assembly	1	04-3880-99	04-3880-99	04-3880-99	04-3880-99
14	Shaft, Pro-Flo®	1	04-3820-03-700	04-3820-03-700	04-3820-03-700	04-3820-03-700
15	Glyd™ Ring	2	08-3210-55-225	08-3210-55-225	08-3210-55-225	08-3210-55-225
16	Gasket, Center Block, Pro-Flo®	2	04-3526-52	04-3526-52	04-3526-52	04-3526-52
17	Air Chamber, Pro-Flo®	2	04-3651-01	04-3651-01	04-3651-05	04-3651-05
18	Screw, HSFHS, 3/8"-16 x 1"	8	71-6250-08	71-6250-08	71-6250-08	71-6250-08
19	Retaining Ring	2	04-3890-03	04-3890-03	04-3890-03	04-3890-03
20	Inner Piston	2	04-3752-01	04-3752-01	04-3752-01	04-3752-01
21	Back-up Diaphragm	2	*	*	*	*
22	Diaphragm, PTFE	2	04-1010-55	04-1010-55	04-1010-55	04-1010-55
23	Outer Piston	2	04-4600-20-500	04-4600-21-500	04-4600-20-500	04-4600-21-500
24	Valve Seat	4	04-1120-20-500	04-1120-21-500	04-1120-20-500	04-1120-21-500
25	Valve Seat, O-Ring (2.609" x .139")	4	04-1200-60-500	04-1200-60-500	04-1200-60-500	04-1200-60-500
26	Valve Ball	4	04-1080-55	04-1080-55	04-1080-55	04-1080-55
27	Chamber, Liquid	2	04-5000-20	04-5000-21	04-5000-20	04-5000-21
28	Large Clamp Band Assy.	2	04-7300-03-500	04-7300-03-500	04-7300-05-500	04-7300-05-500
29	Small Clamp Band Assy.	8	04-7100-03-500	04-7100-03-500	04-7100-05-500	04-7100-05-500
30	Manifold, Discharge Elbow	2	04-5230-20	04-5230-21	04-5230-20	04-5230-21
31	Manifold, Inlet Elbow	2	04-5220-20	04-5220-21	04-5220-20	04-5220-21
32	Manifold, Tee Section	2	04-5160-20	04-5160-21	04-5160-20	04-5160-21
33	Carriage Bolt, Large Clamp Band (5/16"-18x2 1/2 RHSN)	4	04-6070-03	04-6070-03	04-6070-05	04-6070-05
34	Hex Nut, Large Clamp Band (5/16"-18)	4	08-6400-03	08-6400-03	08-6400-05	08-6400-05
35	Carriage Bolt, Small Clamp Band (5/16-18x2 RHSN)	16	08-6050-03-500	08-6050-03-500	08-6050-05-500	08-6050-05-500
36	Hex Nut, Small Clamp Band (1/4"-20)	16	08-6400-03	08-6400-03	08-6400-05	08-6400-05
37	Tee Section O-Ring (2.734" x .139")	4	04-1300-60-500	04-1300-60-500	04-1300-60-500	04-1300-60-500
38	Muffler (Not shown)	1	04-3510-99	04-3510-99	04-3510-99	04-3510-99
39	Pilot Spool Retaining O-Ring	2	04-2650-49-700	04-2650-49-700	04-2650-49-700	04-2650-49-700

*Air Valve Assembly includes item numbers 2 and 3.
DIN Flange: Polypropylene = P/N 04-5160-20-504 PVDF = P/N 04-5160-21-504
0502 Specialty Code = PFA-Coated Hardware
All boldface items are primary wear parts.

Section 9

Elastomer Options

P4 Plastic

Material	Traditional Diaphragms (2)	Valve Balls (4)	Valve Seats (4)	Valve Seat O-Rings (4)	T-Section O-Rings (4)	Reduced Backup Diaphragms (2)	Full-Stroke Backup Diaphragms (2)
Neoprene	04-1010-51	04-1080-51				04-1060-51	
Buna-N	04-1010-52	04-1080-52		04-1200-52-500	04-1300-52-500		
FKM	04-1010-53	04-1080-53					
EPDM	04-1010-54	04-1080-54					
Reduced-Stroke PTFE	04-1010-55	04-1080-55					
Full-Stroke PTFE	04-1040-55	04-1080-55					
PTFE PFA			04-1120-22-500				
PTFE Encap. (FKM)				04-1200-60-500	04-1300-60-500		
Polyurethane	04-1010-50	04-1080-50		04-1200-50-500	04-1300-50-500		
Saniflex™	04-1010-56	04-1080-56				04-1060-56	04-1065-56
Wil-Flex™	04-1010-58	04-1080-58					04-1065-57
Polypropylene			04-1120-20-500				
PVDF			04-1120-21-500				

Backup diaphragms for use with PTFE diaphragms only.

Notes

Notes

PSG
22069 Van Buren Street
Grand Terrace, CA 92313-5651 USA
P: +1 (909) 422-1730 • F: +1 (909) 783-3440
psgdover.com



Where Innovation Flows

PSG[®] reserves the right to modify the information and illustrations contained in this document without prior notice. This is a non-contractual document. 05-2018