



Operating instructions

Hydrostatic level indicator for fuel oil, diesel fuel and water

TankControl 10

- + Read instructions before using product!
- + Observe all safety information!
- + Keep instructions for future use!



Table of contents

1	This instruction manual.....	4
1.1	Precautions	4
2	Safety.....	5
2.1	Intended use.....	5
2.2	Predictable incorrect application	5
2.3	Safe handling	5
2.4	Staff qualification	6
2.5	Modifications to the product	6
2.6	Usage of spare parts and accessories.....	6
2.7	Liability information	6
3	Product description.....	7
3.1	Scope of delivery.....	7
3.2	Properties	8
3.3	Application example	9
3.4	Key functions.....	9
3.5	Overview of the signals	10
3.6	Overview of the display	10
3.7	Overview of the menu structure	12
3.8	Overview of the menu structure (with second submersible probe ZT)	13
3.9	Overview of the menu structure (with floating probe ZS).....	14
4	Technical specifications.....	15
4.1	Approvals, tests and conformities	17
5	Transport and storage	17
6	Mounting.....	18
6.1	Preparing mounting.....	18
6.2	Mounting the control unit.....	18
6.3	Electrical connection	21
6.4	Zero correction of the submersible probe	22
6.5	Mounting the submersible probe.....	23
6.6	Mounting additional submersible probe at the tank (optionally available)	23
6.7	Mounting the floating probe (optionally available).....	25
7	Commissioning	26
7.1	Password.....	26
7.2	Setting time and date	27
7.3	Setting the tank data	28
7.4	Setting the alarms	31

8	Operation	36
8.1	Changing the display language	37
8.2	Alarm condition	38
8.3	Statistics function	39
9	Troubleshooting	41
10	Decommissioning, disposal	41
11	Spare parts and accessories	41
12	Warranty	42
13	Copyright	42
14	Customer satisfaction	42
15	Addresses	42
16	Enabling a retrofitted probe	43



1 This instruction manual

This instruction manual is part of the product.

- ▶ Read this manual before using the product.
- ▶ Keep this manual during the entire service life of the product and always have it readily available for reference.
- ▶ Always hand this manual over to future owners or users of the product.

1.1 Precautions

WARNING WORD



Type and source of the hazard are shown here.

- ▶ Precautions to take in order to avoid the hazard are shown here.

There are three different levels of warnings:

Warning word	Meaning
DANGER	Immediately imminent danger! Failure to observe the information will result in death or severe injuries.
WARNING	Possibly imminent danger! Failure to observe the information may result in death or severe injuries.
CAUTION	Dangerous situation! Failure to observe the information may result in minor or severe injuries as well as damage to property.

2 Safety

2.1 Intended use

The hydrostatic level indicator TankControl 10 may only be used to measure the level of low-viscosity, non-adhesive liquids:

- Fuel oil EL as per DIN 51603-1
- Fuel oil L as per DIN 51603-2
- Diesel fuel as per EN 590
- Water
- Waste water

Any use other than the application explicitly permitted in this instruction manual is not permitted.

2.2 Predictable incorrect application

The hydrostatic level indicator TankControl 10 must never be used in the following cases:

- Hazardous area (Ex)
If the product is operated in hazardous areas, sparks may cause deflagrations, fires or explosions.
- Use as safety equipment
TankControl 10 does **not** replace the function of a level sensor at the fuel oil tank.
- Use as overflow prevention system
- Level measurement in tanks containing blackwater
- Use of the relays for safety-related purposes

2.3 Safe handling

This product represents state-of-the-art technology and is made according to the pertinent safety regulations. Each product is subjected to a function and safety test prior to shipping.

- ▶ Operate the product only when it is in perfect condition. Always observe the operating instructions, all pertinent local and national directives and guidelines as well as the applicable safety regulations and directives concerning the prevention of accidents.

Extreme environmental conditions have negative effects on the function of the product.

- ▶ Protect TankControl 10 from shocks.
- ▶ Only use the control unit indoors.
- ▶ Protect the control unit from humidity.



2.4 Staff qualification

The product may only be mounted, commissioned, operated, maintained, decommissioned and disposed of by qualified, specially trained staff.

Electrical work may only be performed by trained electricians and in compliance with all applicable local and national directives.

2.5 Modifications to the product

Changes or modifications made to the product by unauthorised persons may lead to malfunctions and are prohibited.

2.6 Usage of spare parts and accessories

Usage of unsuitable spare parts and accessories may cause damage to the product.

- ▶ Use only genuine spare parts and accessories of the manufacturer (see chapter 11, page 41).

2.7 Liability information

The manufacturer shall not be liable in any form whatsoever for direct or consequential damage resulting from failure to observe the technical instructions, guidelines and recommendations.

The manufacturer or the sales company shall not be liable for costs or damages incurred by the user or by third parties in the usage or application of this product, in particular in case of improper use of the product, misuse or malfunction of the connection, malfunction of the product or of connected products. The manufacturer or the sales company shall not be liable for damage whatsoever resulting from any use other than the use explicitly permitted in this instruction manual.

The manufacturer shall not be liable for misprints.

3 Product description

3.1 Scope of delivery



Fig. 1: Scope of delivery TankControl 10

No.	Basic	With second submersible probe (ZT)	With floating probe (ZS)
1	Control unit with probe cable		
2	1 x universal submersible probe with probe cable	2 x universal submersible probe with probe cable	1 x universal submersible probe with probe cable
3	-	-	1 x floating probe with probe cable
4	1 x cable gland kit G1 x G1½ x G2	2 x cable gland kit G1 x G1½ x G2	1 x cable gland kit G1 x G1½ x G2
5	1 x mounting kit for withdrawal flange at plastic battery tanks	2 x mounting kit for withdrawal flange at plastic battery tanks	1 x mounting kit for withdrawal flange at plastic battery tanks
6	1 x moisture-proof junction box with terminal strip and fastening material	2 x moisture-proof junction box with terminal strip and fastening material	1 x moisture-proof junction box with terminal strip and fastening material
	Bag of accessories (not shown) with 2 screws and 2 dowels for wall mounting		



3.2 Properties

TankControl 10 consists of a control unit with graphical display and a submersible probe with integrated pressure measuring cell. The level can be displayed in litres, cubic metres, percent or liquid level in millimetres. When the level falls below or exceeds an adjustable minimum or maximum value, the control unit triggers visual and, if desired, audible (can be acknowledged) alarms.

Two additional relay contacts are available for external alarm devices, for level control or for connection to telecommunication or building control systems. An integrated microprocessor records, stores and displays important information such as consumption or calculation of remaining range (based consumption history).

TankControl 10 ZT extras

The differential alarm of the second submersible probe is used to detect different liquid levels in communicating tanks. In the case of multiple tanks, the first submersible probe should be installed in the first tank, the second submersible probe in the last tank. If, for example, the communicating connection between the tanks is clogged, this results in unwanted, different liquid levels in the tanks. This condition triggers an alarm.

TankControl 10 ZS extras

The additional floating probe can be used, for example, for backflow alarms.

3.3 Application example





Fig. 2: Application example 10

3.4 Key functions

Key	Function
	Scroll down/left.
	Scroll up/right.
	Display main menu. Select and confirm.
	Acknowledge button: Switch off buzzer during an alarm condition and display the alarm acknowledgement menu.



3.5 Overview of the signals

Alarm signal	Setting
Audible alarm 	Buzzer sounds during an alarm condition, depending on the setting.
Visual alarm 	Red LED is always on during an alarm condition.

3.6 Overview of the display

The display backlight is automatically switched off 5 minutes after the last time a key was pressed. Press any key to switch on the display again.

Display

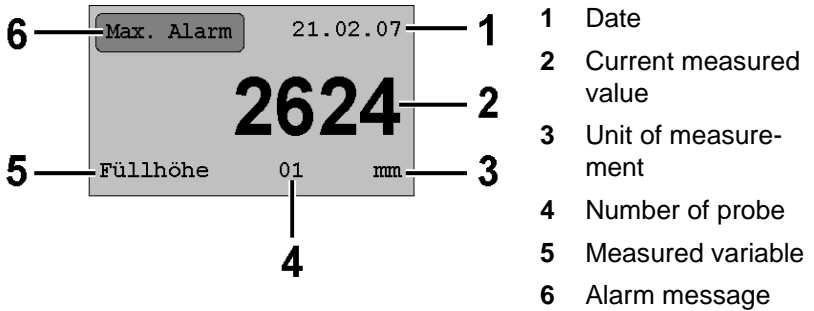

Fig. 3: Indication of liquid level for submersible probe

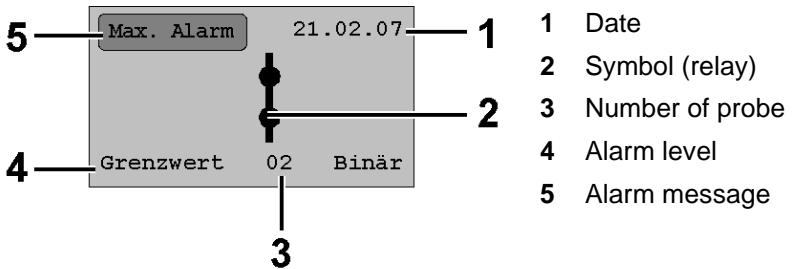
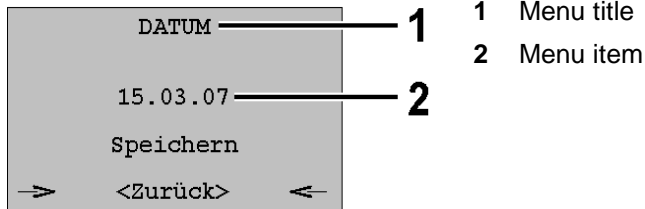

Fig. 4: Status indication for floating probe



Alarm message	Meaning
Sensor?	Sensor inoperative
Min. Alarm	Minimum alarm
Max. Alarm	Maximum alarm
Diff. Alarm	Differential alarm (with second submersible probe ZT)
Schw. Alarm	Floating probe alarm (with floating probe ZS)

Menu



Display	Meaning
Save	Save the changed value
<Back>	Back to previous menu without saving
→ ←	Highlight the selected menu item



3.7 Overview of the menu structure

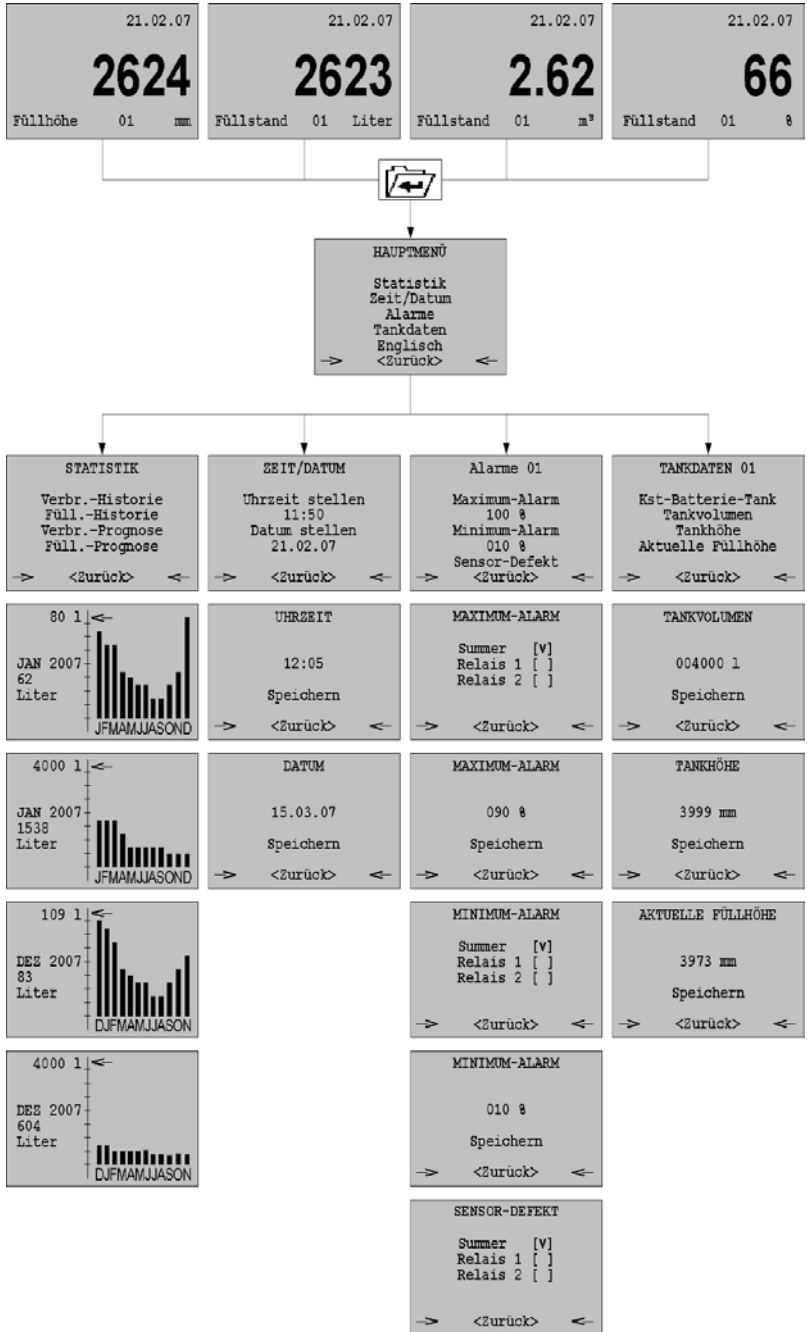



3.8 Overview of the menu structure (with second submersible probe ZT)

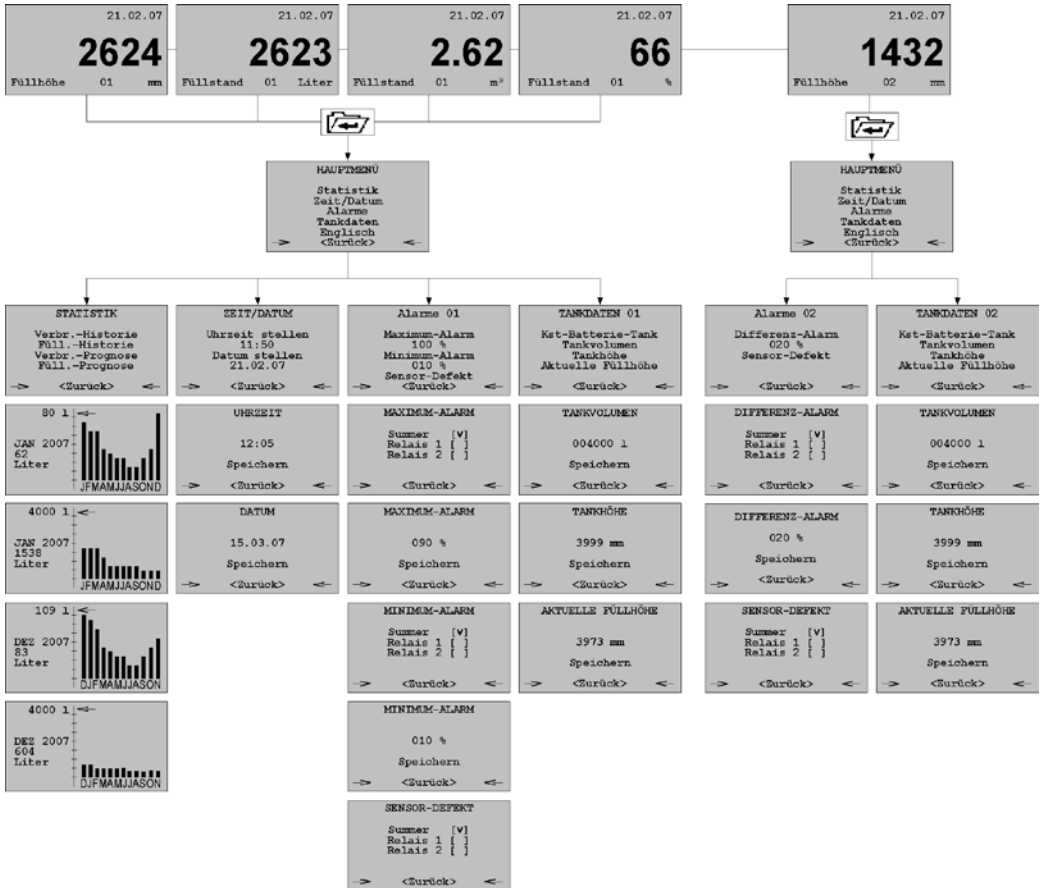



3.9 Overview of the menu structure (with floating probe ZS)

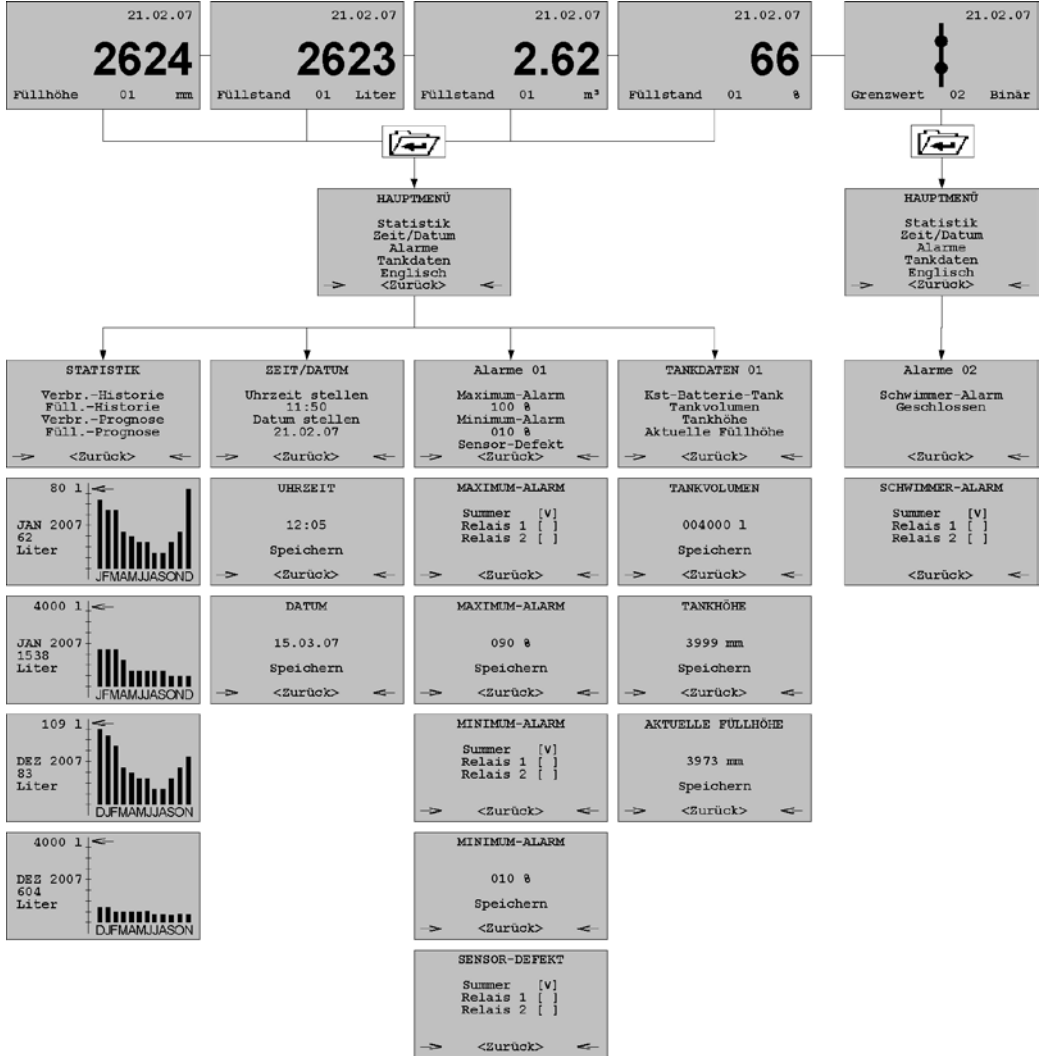



4 Technical specifications

Table 1: Technical specifications control unit

Parameter	Value
General specifications	
Dimensions housing (W x H x D)	100 x 188 x 65 mm
Length of probe cable	15 m
Housing material	Plastic, ABS
Operating temperature range	
Ambient	0 °C to +45 °C
Storage	-5 °C to +80 °C
Supply voltage	
Nominal voltage	AC 230 V ± 10 %
Nominal power	5 VA
Electrical safety	
Protection class	II (EN 60730)
Degree of protection	IP 54 (EN 60529; as delivered)
Electromagnetic compatibility (EMC)	
Interference	EN 61000-6-4
Noise immunity	EN 61000-6-2

Table 2: Technical specifications universal submersible probe

Parameter	Value
General specifications	
Dimensions (Ø x L)	24 x 53 mm
Weight	415 g
Length of probe cable	6 m
Pressure range	0-400 mbar
Accuracy*	≤ ± 0.5 % FSO, IEC 60770
Temperature error	≤ ± 0.3 % FSO, 10°K



Parameter	Value
Material	
Housing	Stainless steel 1.4301
Cable	PVC (fuel oil-resistant)
Spacer	POM, PE
Other wetted parts	Stainless steel 1.4301, 1.4435, FKM
Operating temperature range	
Medium	-5 °C to +70 °C
Storage	-5 °C to +70 °C
Electrical safety	
Degree of protection	IP 68 (EN 60529)
Electromagnetic compatibility (EMC)	
Interference	EN 61000-6-4
Noise immunity	EN 61000-6-2

Table 3: Technical specifications floating probe

Parameter	Value
General specifications	
Dimensions (Ø x L)	24 x 85 mm
Weight	350 g
Length of probe cable:	
Standard length	5 m
Max. length	50 m (shielded)
Resistance	Water, oils
Probe voltage	Max. 17 V, AC
Material	
Housing	Polypropylene
Probe cable	Öflex 2 x 0.5 mm ²
Operating temperature range	
Medium	-5 °C to +50 °C
Storage	-10 °C to +60 °C



Parameter	Value
Electrical safety	
Degree of protection	IP 68 (EN 60529)

* Accuracy of the complete system with reference to the indication of the liquid level in mm: $< \pm 0.5 \% \text{ FSO}$, IEC 60770

Cable glands at control unit

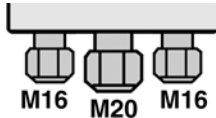

Cable gland	Cable diameter
M16	4.0-8.8 mm
M20	8.0-12.5 mm

4.1 Approvals, tests and conformities

TankControl 10 complies with the EMC Directive (2014/30/EU) and the Low Voltage Directive (2014/35/EU).

5 Transport and storage

CAUTION Damage to the product due to improper transport.



- ▶ Do not throw or drop the product.

CAUTION Damage to the product due to improper storage.



- ▶ Protect the product from shock when storing it.
 - ▶ Store the product in a clean and dry environment.
 - ▶ Only store the product within the permissible temperature range.
-

6 Mounting

6.1 Preparing mounting

- ▶ Only use the control unit indoors.
- ▶ Protect the control unit from humidity.
- ▶ Mount the control unit to a plane, rigid and dry wall at eye level.
- ▶ Mount the control unit in such a way that it is accessible and easy to oversee at all times.
- ▶ The enclosed moisture-proof junction box is not suitable for outdoor applications. Use the outdoor junction box for outdoor applications, see chapter 11, page 41.

6.2 Mounting the control unit

1. Open the control unit.

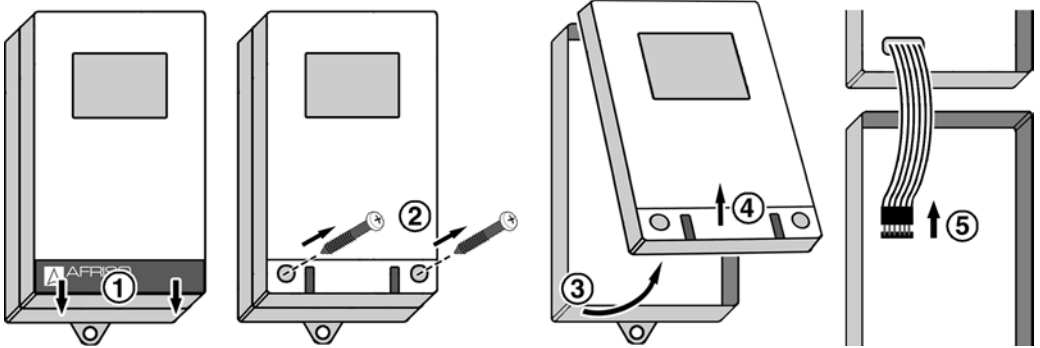

2. Mount the control unit to the wall.

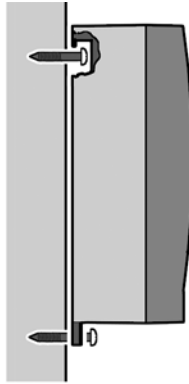
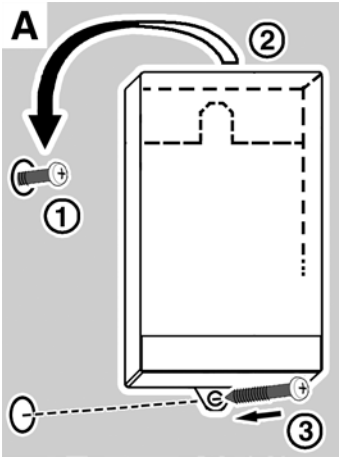

IP 54

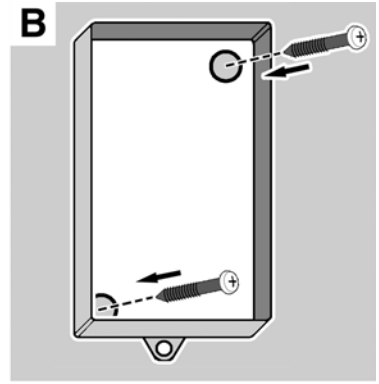

IP 40

- A**
- 1 Mount the screw to the wall.
 - 2 Fit the control unit.
 - 3 Fixate the control unit by screwing the bottom lug to the wall.
- B**
- Drill the fixing holes in the bottom part with a \varnothing 5 mm drill.
Mount the bottom part to the wall with the screws shipped with the unit.
3. Mount the junction box for connecting the cable of the submersible probe and the cable of the control unit at the desired position.
 4. Route the cable of the control unit into the junction box.
 5. Push the cable gland required for the tank (cable gland kit or mounting kit, see chapter 6.6, page 23) onto the cable of the submersible probe; verify correct orientation.



6. Route the cable of the submersible probe to the junction box and connect the two cables using the enclosed terminal strip. Only connect identical wire colours.

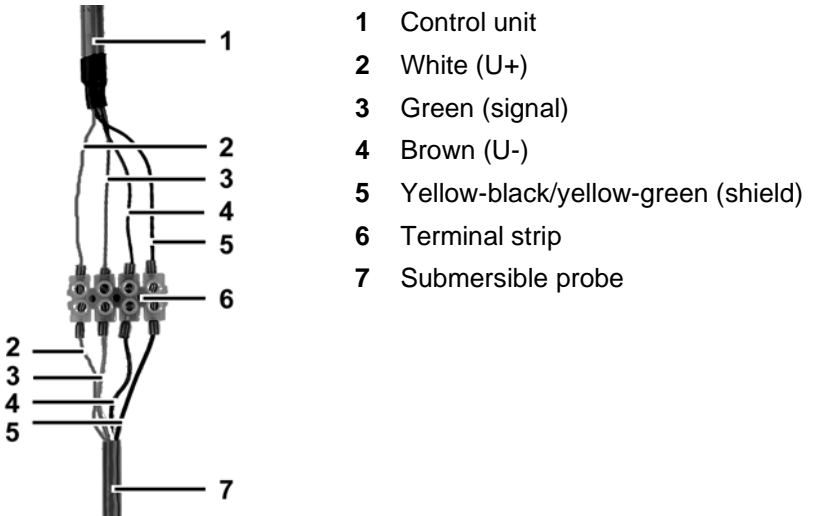

- 1 Control unit
- 2 White (U+)
- 3 Green (signal)
- 4 Brown (U-)
- 5 Yellow-black/yellow-green (shield)
- 6 Terminal strip
- 7 Submersible probe

Fig. 5: Cable connection control unit and submersible probe

7. A transparent hose protrudes from the cable end of the pressure sensor. This hose provides the pressure sensor with the atmospheric pressure. Do not close or bend the hose. If the hose is closed or bent, this results in incorrect measurements. Sealing the junction box in such a way that it is airtight also causes incorrect measurements. Close the junction box in such a way that it is not completely airtight.
8. Connect the unit electrically, see chapter 6.3, page 21.
9. Close the control unit.

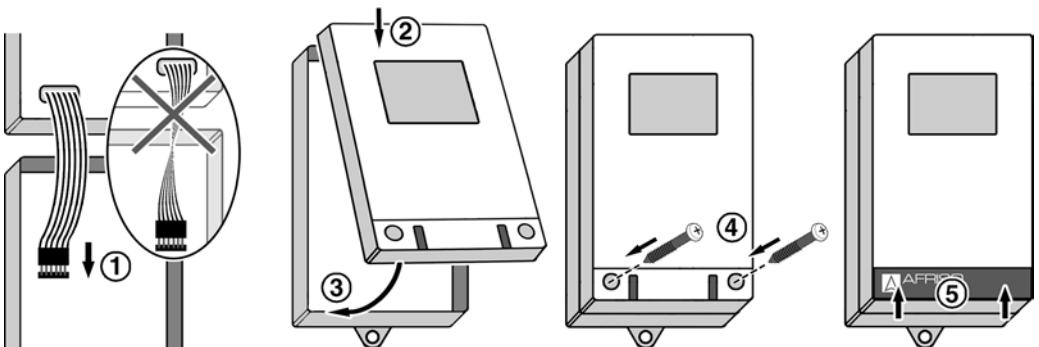

6.3 Electrical connection

The probe cable for the submersible probe is factory-connected.

- Mains voltage is interrupted and cannot be switched on.

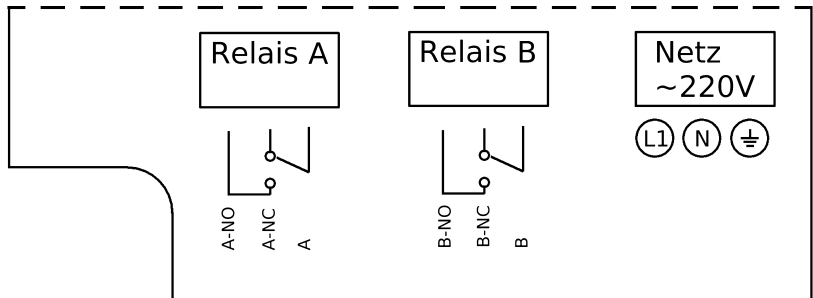

Fig. 6: Wiring diagram

Connecting a relay

1. Route the relay cable through the centre cable gland.
2. Connect the relay cable to the connection "Relais A" or to the connection "Relais B":
If no error condition is present, the relay is de-energised; in case of an alarm, the relay is energised.

NO	Relay – Normally Open	Not connected to terminal A at connection relay A or B
NC	Relay – Normally Closed	Connected to terminal A at connection relay A or B

INFO

The additional submersible probe is optionally available.

Connecting submersible probe 2 for differential alarms

1. Route the probe cable through the centre cable gland.
2. Connect the probe cable to "Sensor2" in the following way:
Yellow-green to terminal "Schirm" (shield), green to terminal "Signal", brown to terminal "AGND" and white to terminal "Vcc".
3. An additional submersible probe must be enabled via the software at the control unit, see chapter 16, page 43.

**INFO**

The additional floating probe is optionally available.

Connecting the floating probe

1. Route the probe cable through the centre cable gland.
2. Connect the probe cable to "Sensor2" at the terminals "Signal" and "AGND"; any polarity.
3. An additional submersible probe must be enabled via the software at the control unit, see chapter 16, page 43.

Standard shielded cable 2 x 0.5 mm² can be used to extend the probe cable. The maximum length of the extension cable is 50 m.

CAUTION**Interference**

- ▶ Verify that the probe cable is not routed next to a power cable.

Protect the probe cable from damage, for example by means of a suitable cable duct.

Connecting the unit to mains

1. Route the mains cable through the cable gland at the right.
2. Connect the phase to terminal L1, the neutral conductor to terminal N and the protective conductor to terminal .

6.4 Zero correction of the submersible probe

- The submersible probe is in air.
- The submersible probe and the control unit are connected.
- Mains voltage is connected and on.
- ▶ Set the current liquid level to "000000 mm" see fig. 12, page 29.
- ↵ You have now set the zero point of the probe.

6.5 Mounting the submersible probe

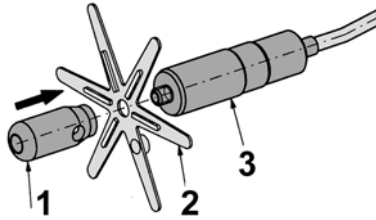

- 1 Spacer
- 2 Star
- 3 Pressure sensor

1. Plug the star onto the pressure sensor. Note the position of the ribs at the star.
2. Use the spacer to screw the star to the pressure sensor.
3. Insert the submersible probe into the tank from the top.
4. At the cable gland, adjust the cable length of the probe cable in such a way that the probe tip reaches the tank bottom. The measuring hole of the submersible probe must not be immersed in sludge that may be present at the tank bottom. Any volume of liquid below the measuring hole of the submersible probe is not detected by the pressure sensor.

6.6 Mounting additional submersible probe at the tank (optionally available)

The differential alarm of the second submersible probe is used to detect different liquid levels in communicating tanks. In the case of multiple tanks, the first submersible probe should be installed in the first tank, the second submersible probe in the last tank.

Cable gland kit

Free 1", 1½" or 2" threaded socket in the tank:

1. Route the cable of the submersible probe through the 1" cable gland. For mounting to the tank, use the appropriate parts of the cable gland kit required for your specific tank.

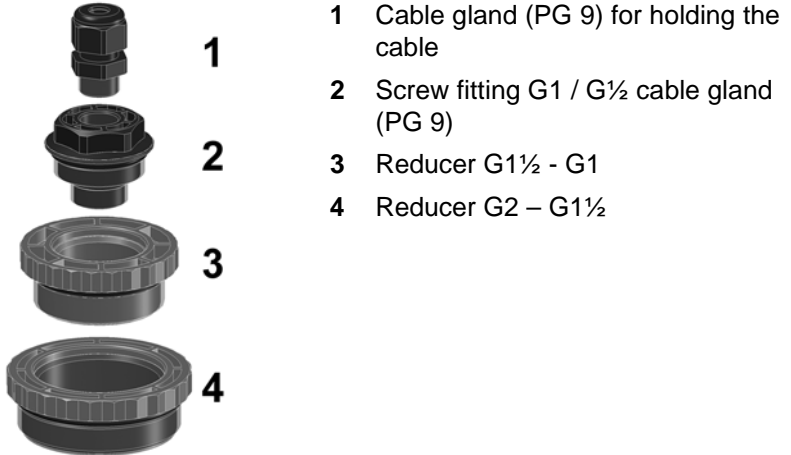

Fig. 7: Mounting to tank with cable gland kit

2. Tighten the cable gland so that the cable can no longer be moved and that the connection is odour-tight.

Mounting kit

In a mounting flange with union nut, in a screw cap or in a free blind connection:

1. Remove the mounting flange, the cap or the blind connection from the tank and drill a 15 mm hole.

CAUTION



Damage to the tank or the system due to improper mounting

- ▶ Only use existing tank connections to install the product.
- ▶ Do not drill directly into the tank, but only into existing mounting flanges, caps or blind connections.
- ▶ Verify that no foreign matter such as drilling chips can get into the tank during mounting.



- 1 Cable gland (PG 9)
- 2 Mounting flange

Fig. 8: Mounting to tank with mounting kit

2. Insert the enclosed cable gland (PG 9) and fasten it with the enclosed nut.
3. Insert the cable of the submersible probe into the cable gland (PG 9) and fixate it at the correct length so that it is odour-tight.

6.7 Mounting the floating probe (optionally available)

- ▶ Fasten the floating probe with the enclosed cable gland 1" in such a way that it is at the height at which the alarm is to be triggered (switching point).

The weight at the floating probe keeps the floating probe vertical in the liquid.

7 Commissioning

For commissioning, you must enter the tank data. The accuracy of the measured values displayed depends on the accuracy of the tank data determined and entered by the user.

7.1 Password

In order to avoid inadvertent changes, a password must be entered before changes can be made. After you have entered the correct password, the edit mode is active for 15 minutes.

If you do not make any changes for a period of 15 minutes after you have entered the correct password, access is locked automatically.

The password is **186900**.

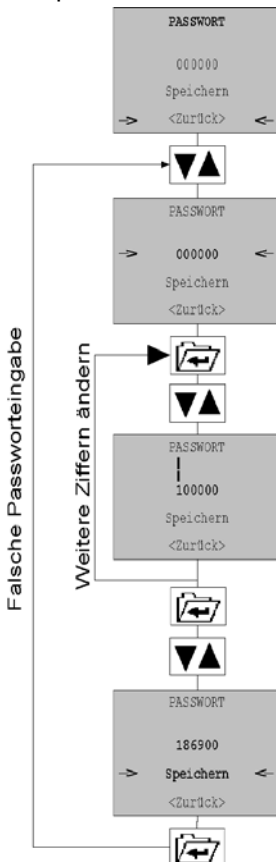

Fig. 9: Entering the password

7.2 Setting time and date

- The date format is "DD.MM.YY"
- The time format is "hh:mm"

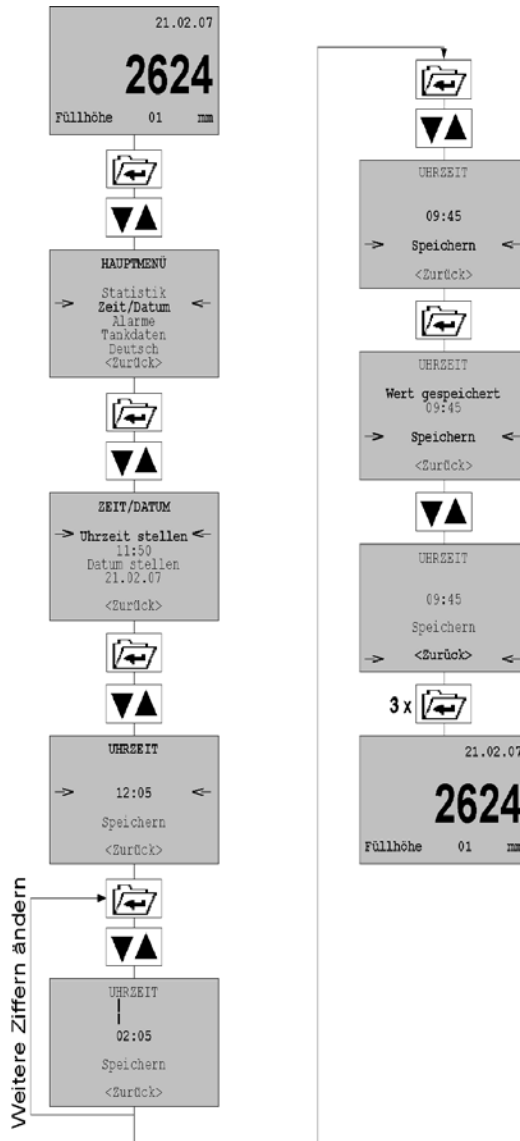

Fig. 10: Changing date and time; example: time

7.3 Setting the tank data

Floating probe

No tank data need to be set for the floating probe.

Submersible probe 1: Selecting the tank shape

The following tank shapes are available:

- Plastic battery tank
- Linear tank
- Cylindrical tank
- Spherical tank
- Oval tank
- Plastic tank with recess
- Hemispherical cistern

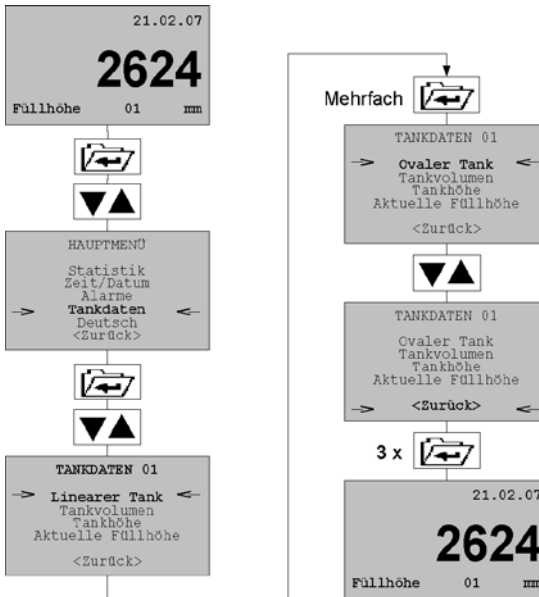

Fig. 11: Changing the tank shape



Submersible probe 1: Tank volume, tank height and current liquid level

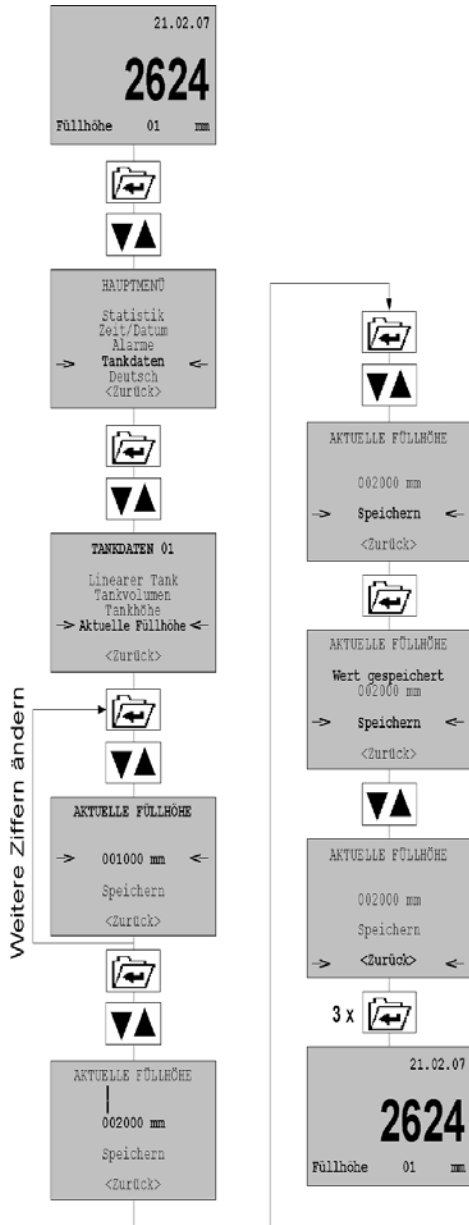
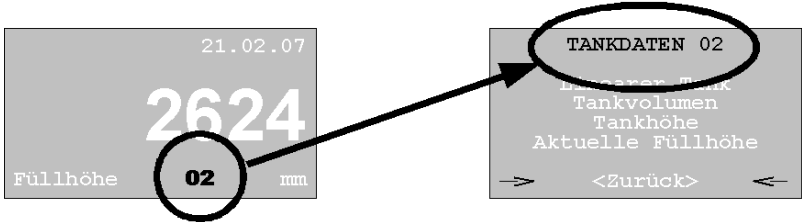

Fig. 12: Changing the tank data; example: liquid level

Submersible probe 2: Setting the current liquid level

- ▶ Activate tank data menu 2 and set the current liquid level as shown in fig. 12, page 29.



The differential alarm depends on the tank height of the tank in which submersible probe 1 is installed and on the current liquid levels measured by both submersible probes.

Therefore, it is neither necessary to select a tank shape for submersible probe 2 nor to set the tank volume or the tank height.

7.4 Setting the alarms

Submersible probe 1: Setting buzzer and relays

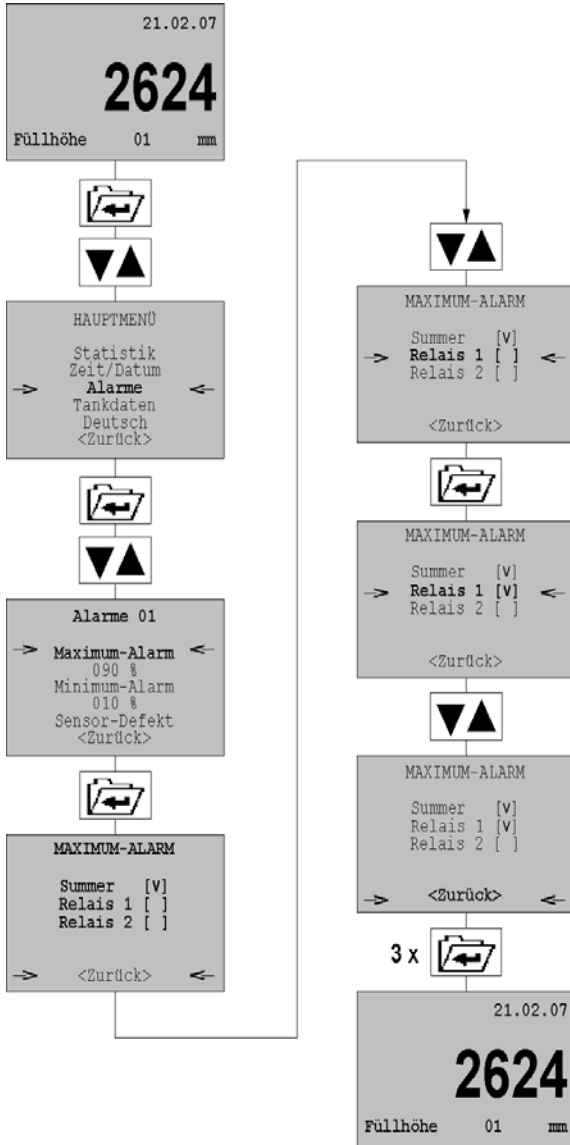

Fig. 13: Buzzer/relay settings; example: Maximum alarm



Floating probe: Setting buzzer and relays

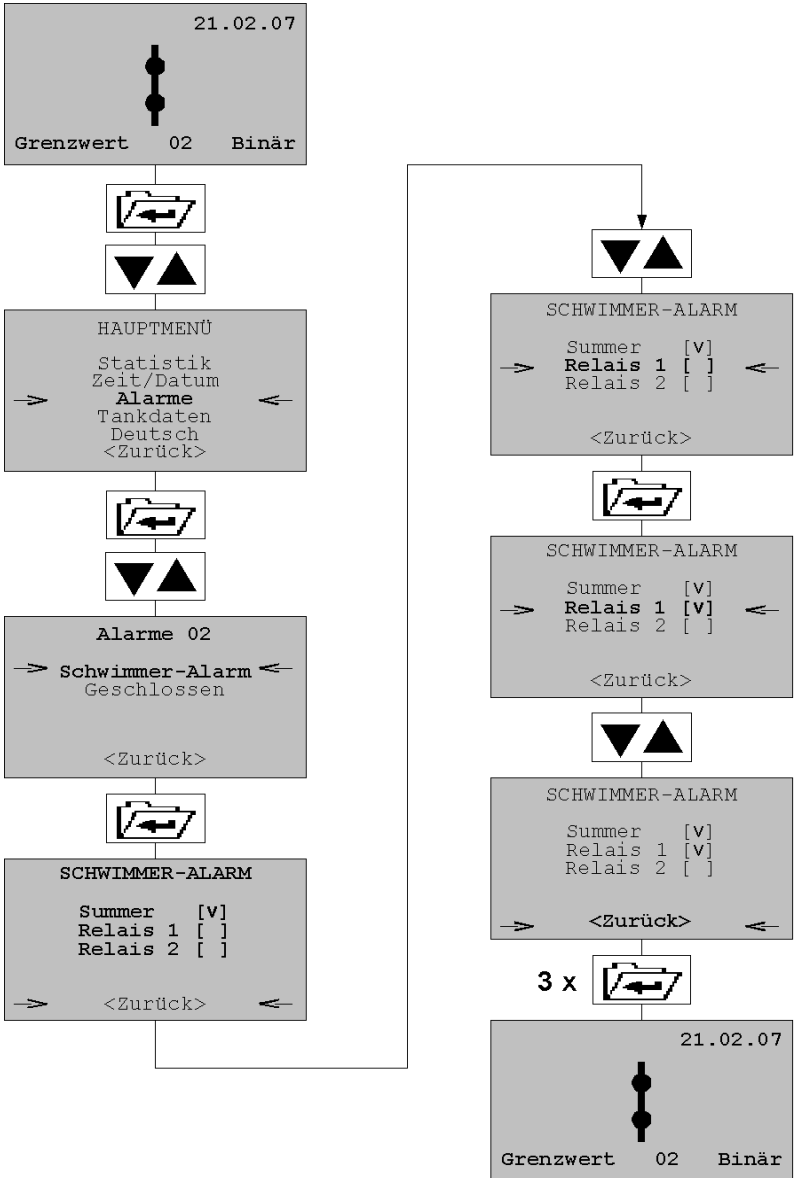

Fig. 14: Buzzer/relay settings for alarm via floating probe

Floating probe: Settings for triggering of alarm

Closed (1): Alarm is triggered in closed state.

Opened (0): Alarm is triggered in open state.

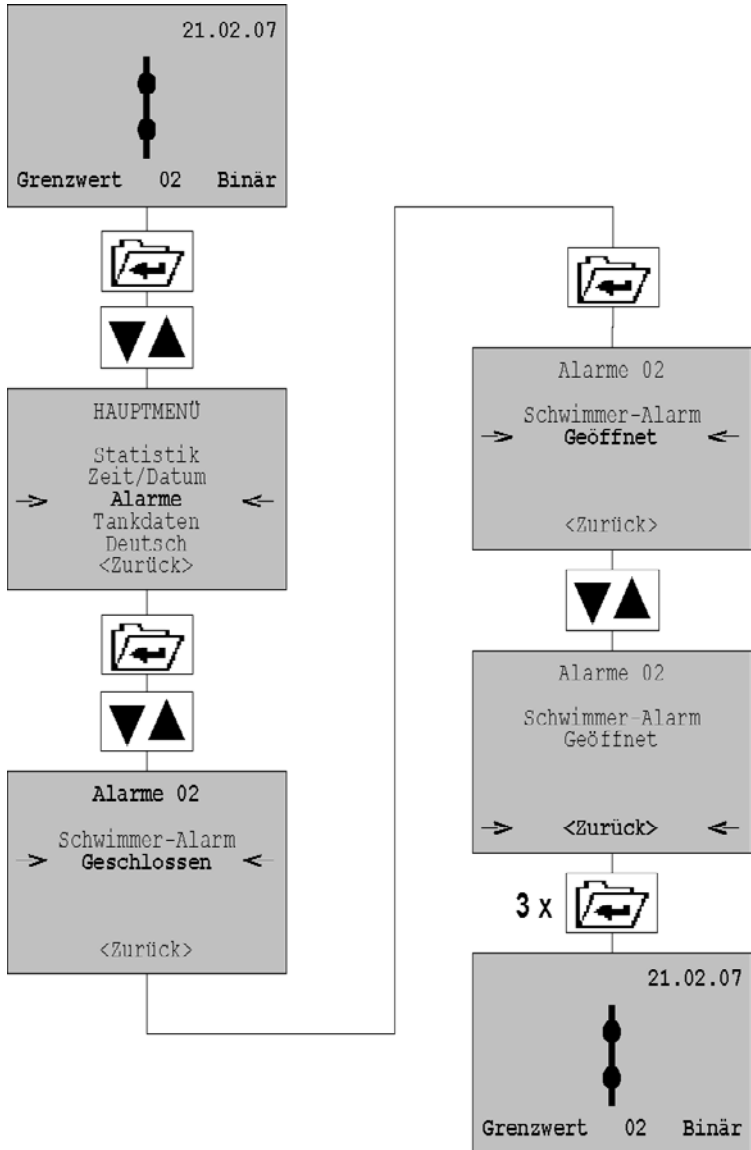

Fig. 15: Triggering alarm in opened/closed state



Submersible probe 1: Setting the alarm thresholds

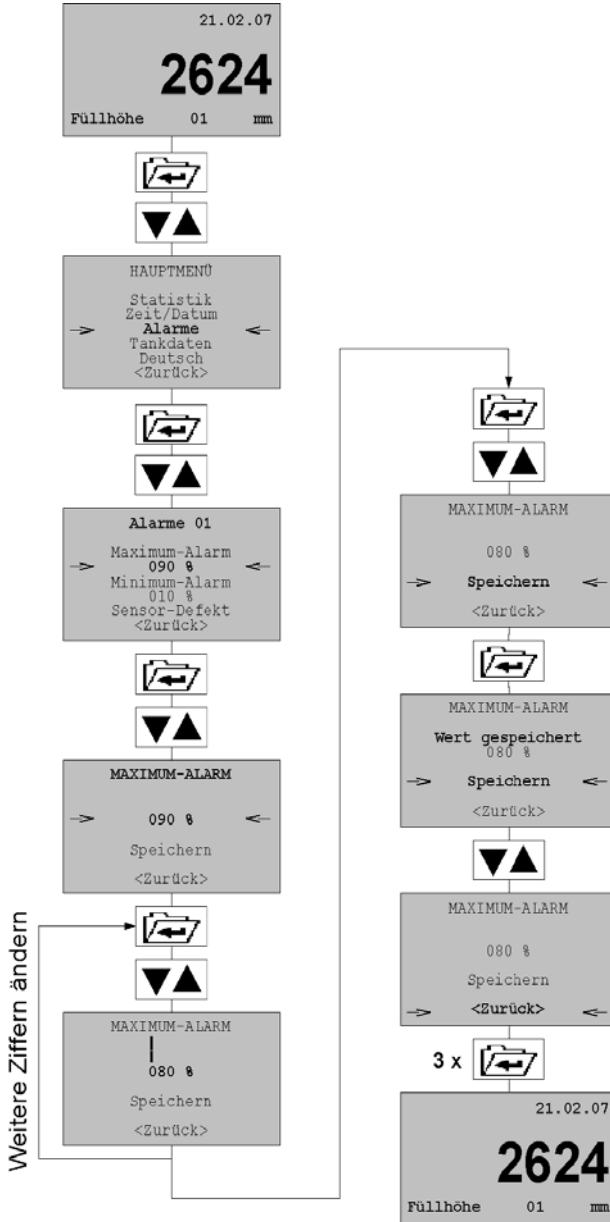
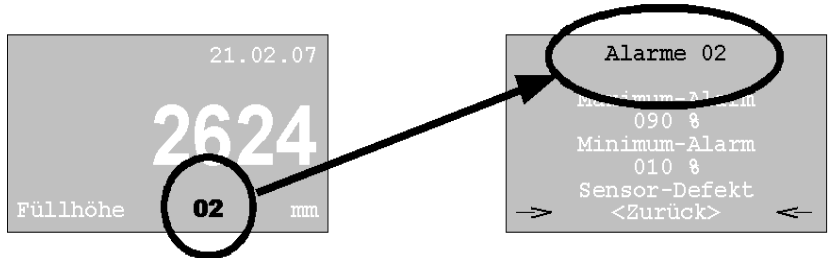

Fig. 16: Alarm threshold settings; example: Maximum alarm

Submersible probe 2: Setting the alarm threshold for differential alarm

The percentage relates to the tolerated difference between the two liquid levels. If the difference is exceeded, an alarm is triggered.

- ▶ Activate alarm menu 2 and continue as shown in fig. 16 on page 34.



Submersible probe 2: Setting buzzer and relays

- ▶ Activate alarm menu 2 and continue as shown in fig. 13 on page 31.

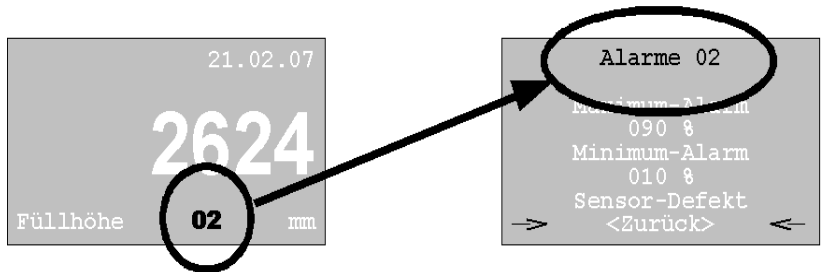



8 Operation

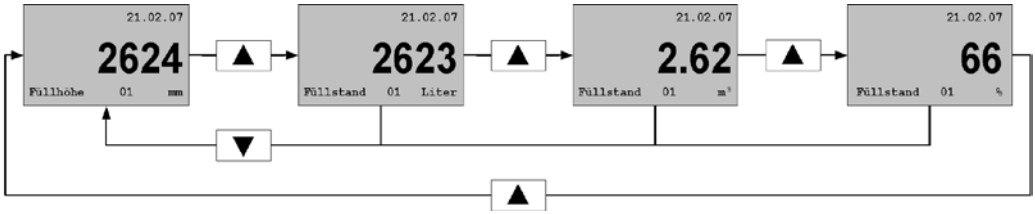

Fig. 17: Display level with the available units (with one submersible probe)

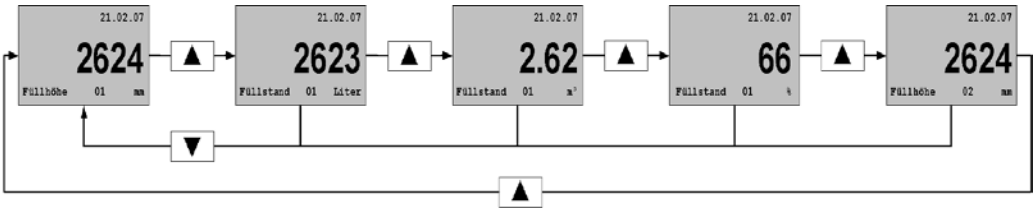

Fig. 18: Display level with the available units (with two submersible probe)

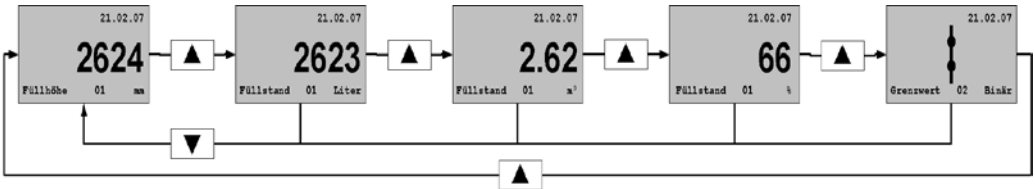

Fig. 19: Display level with the available units and display limit value (with floating probe)

- ▶ Scrolling from screen to screen: Press the key σ .
- ▶ Direct jump to screen "Level in mm": Press the key key τ .

8.1 Changing the display language

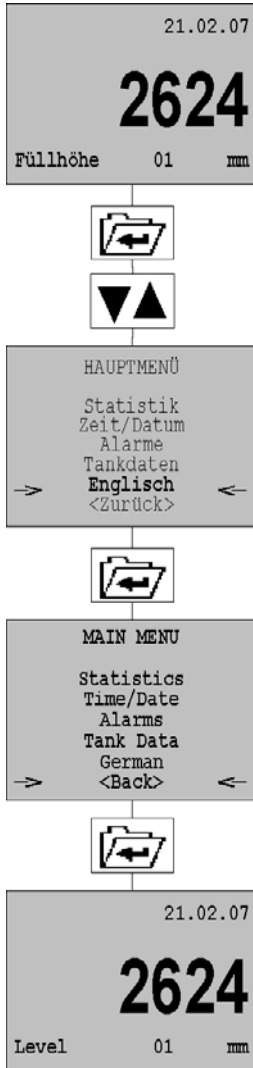

Fig. 20: Changing the display language; example: German → English



8.2 Alarm condition



Alarm message on screen



LED is on



Audible alarm (if set)



Relay is energised (if set)

1. Press the Acknowledge button to acknowledge the audible alarm.



- ↳ The "Acknowledge" menu is displayed.

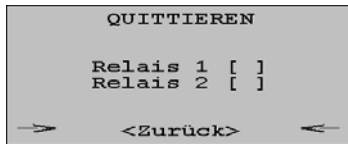

2. Acknowledge the relay(s), if necessary.

Display	Meaning
Relay []	Relay is not energised and does not need to be acknowledged.
Relay [x]	Relay is energised and can be acknowledged.
Relay [v]	Relay has been acknowledged.

- ↳ The alarm message on the display and the LED remain active as long as the cause of the alarm has not been removed and the alarm condition persists.

8.3 Statistics function

The Statistics function allows you to monitor consumption and level (**consumption history** and **level history**) and to predict consumption and level (**consumption forecast** and **level forecast**). The statistics is refreshed every first day of the month.

The Forecast function is not available until one year after commissioning since the forecast is calculated on the basis of the of the consumption and level data of the previous years. When the Forecast function is activated during the first year, the system displays the date as of which the forecast will be available (DD.MM.YY).

Table 4: Statistics function

Type	Period shown on the display	Maximum total period	Unit
History	1 calendar year	Last 5 calendar years (if the data is available)	Litres
Forecast	12 months after current date	12 months	Litres

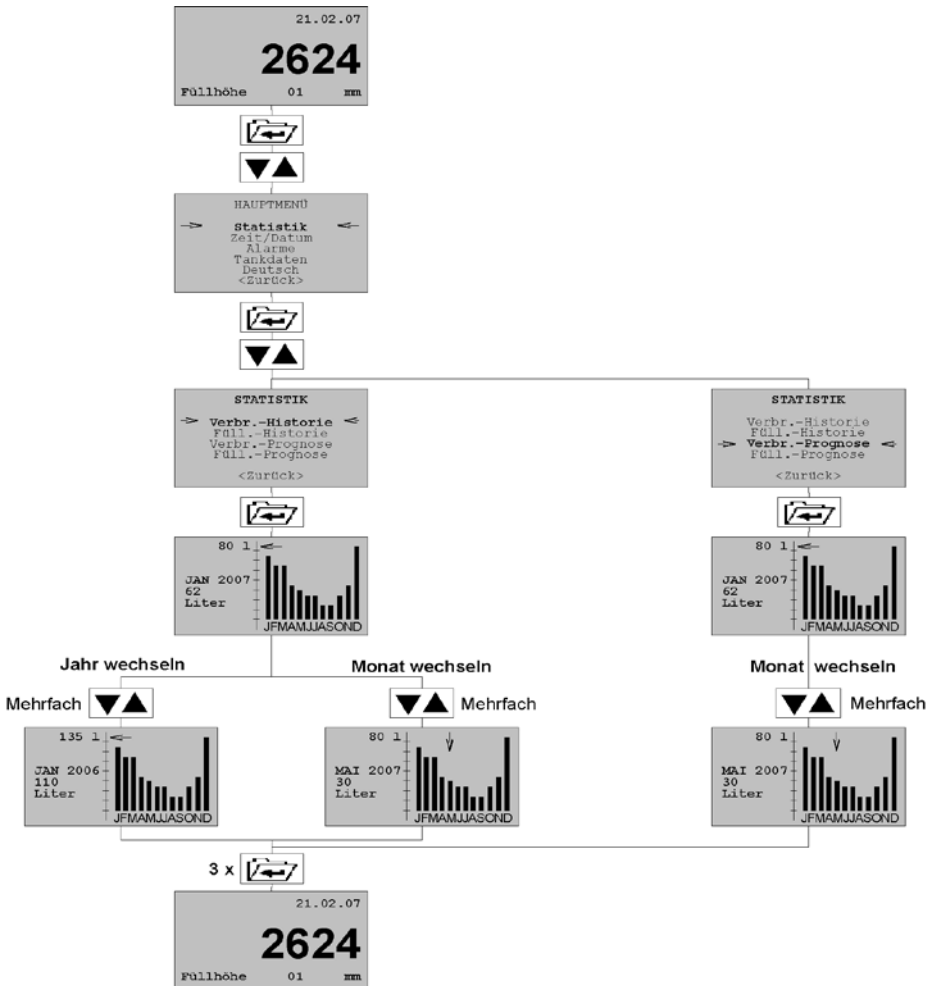

Fig. 21: Statistics; example: Consumption history and consumption forecast

History: Displaying the previous year

- ☑ Arrow points to January.
- ▶ press key τ .
- ↶ Previous year is displayed.

History: Displaying the next year

- ☑ Arrow points to December.
- ▶ press key σ .
- ↷ Next year is displayed.

9 Troubleshooting

Repairs may only be performed by specially trained, qualified staff.

Table 5: Troubleshooting

Problem	Possible reason	Repair
Display re-mains blank	Mains voltage is interrupted	▶ Supply mains voltage
	Mains cable is not properly connected	▶ Properly connect the mains cable, see chapter 6.3, page 21
Incorrect level indication	Incorrect tank data entered	▶ Correct tank data, see chapter 7.3, page 28
Other malfunctions	–	▶ Send the product to the manufacturer

10 Decommissioning, disposal



1. Switch off the supply voltage.
2. Dismount TankControl 10 (see chapter 6, page 18, reverse sequence of steps).
3. To protect the environment, this product must **not** be disposed of together with the normal household waste. Dispose of the product according to local directives and guidelines.

This product consists of materials that can be reused by recycling firms. The electronic inserts can be easily separated and the device consists of recyclable materials.

If you do not have the opportunity to dispose of the used device in accordance with environmental regulations, please contact us for possibilities to return it.

11 Spare parts and accessories

Part	Part no.
TankControl 10	52150
Submersible probe with star and spacer	52153
Star for submersible probe	11.67.040010
Spacer for submersible probe	11.67.040011
Floating probe	16703
Moisture-proof junction box	639.000.0004



Part	Part no.
Outdoor junction box	31824
Terminal strip, 4 poles	690.000.0009
Mounting kit	685.000.0044
Cable gland kit	52125
Mounting frame	43521
Mains cable with flat connector, 1.5 m	556.000.0016

12 Warranty

The manufacturer's warranty for this product is 24 months after the date of purchase. This warranty shall be good in all countries in which this product is sold by the manufacturer or its authorised dealers.

13 Copyright

The manufacturer retains the copyright to these operating instructions. These operating instructions may not be reprinted, translated, copied in part or in whole without prior written consent.

We reserve the right to technical modifications with reference to the specifications and illustrations in this manual.

14 Customer satisfaction

Customer satisfaction is our prime objective. Please get in touch with us if you have any questions, suggestions or problems concerning your product.

15 Addresses

The addresses of our worldwide representations and offices can be found on the Internet at www.afriso.com.



16 Enabling a retrofitted probe

NOTE **You can connect only one additional probe to TankControl 10.**

You can connect only one additional probe to Tank Control 10: either a floating probe or a second submersible probe.

This probe must be enabled via the software of Tank Control 10.

Password	For which type
726452	Second submersible probe (ZT)
234585	Floating probe (ZS)

- The second submersible probe (see page 21) or the floating probe (see page 22) have been connected to the control unit.
1. To access the menu for entering the password, select any menu (for example, *Change Language*, see chapter 8.1, page 37).
 2. Then enter one of the passwords listed above (depending on the type of probe).

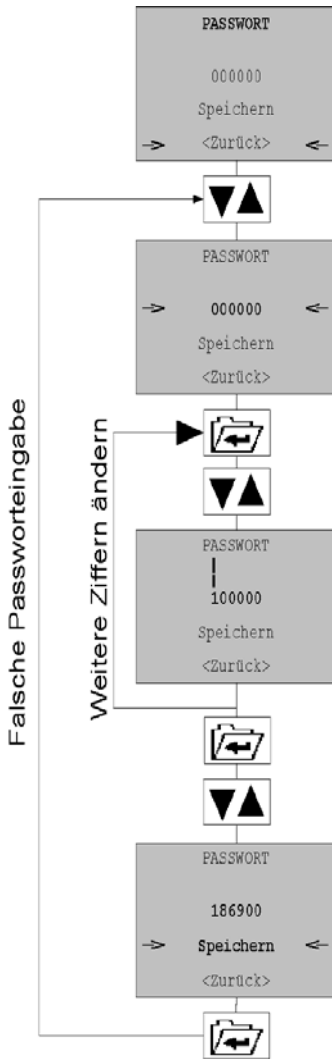

Fig. 22: Entering the password for an additional probe

- ↩ The additional probe is now enabled.
- ↩ TankControl 10 is ready for operation.