

Operating Instructions G-BH1N | G-BH9N

2BH14 | 2BH15 | 2BH16 | 2BH18 | 2BH19 | 2BH923

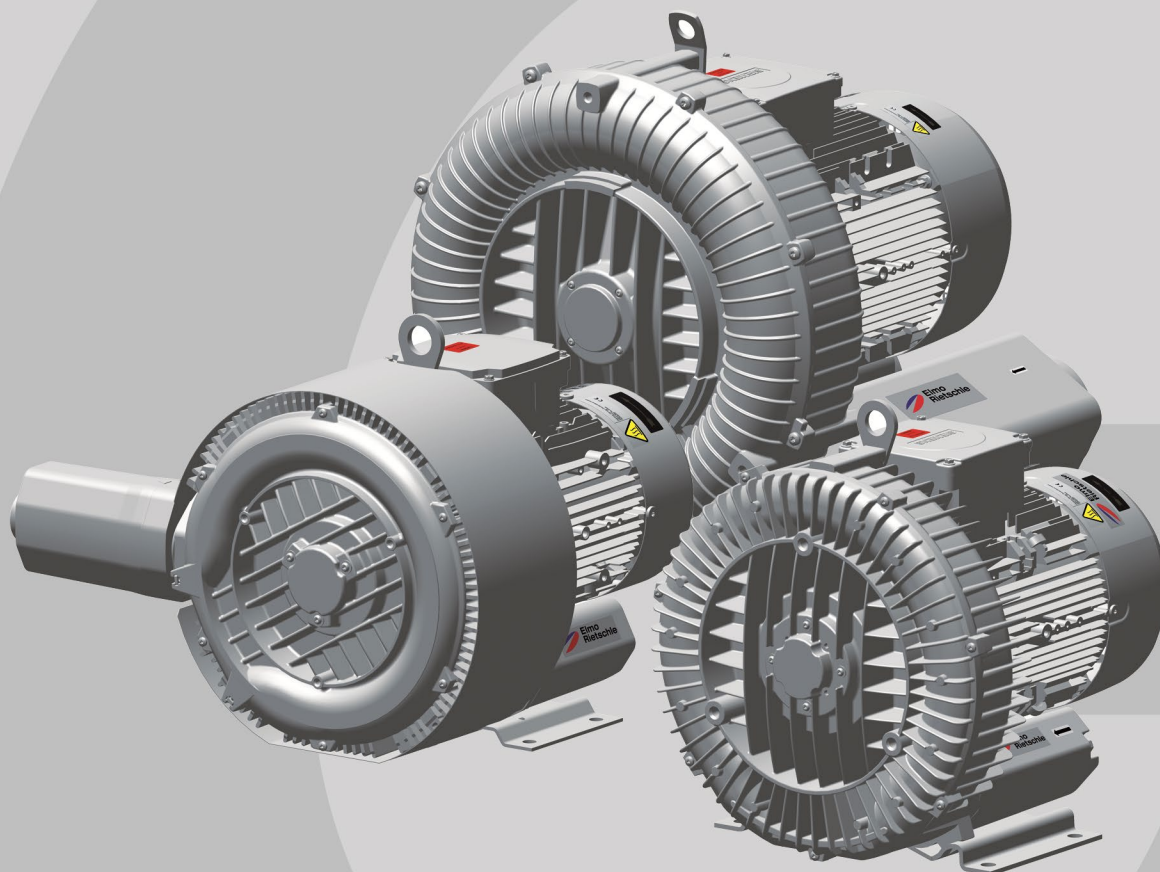

G-Serie
G-Series
Seitenkanal
Side Channel



1	About this manual	4
1.1	Content of this document	4
1.2	Target group	4
1.3	Explanation of the terms and symbols	4
1.4	Changes in comparison to the previous version	6
1.5	Other valid documents	6
2	Safety and responsibility	7
2.1	Explanation of warning signs	7
2.2	Correct use of the equipment	7
2.3	Unauthorised operation	7
2.4	Working in a safety-conscious manner	8
2.5	Requirements for personnel	9
2.5.1	Personnel qualifications and training	9
2.5.2	Personal protective equipment	10
2.6	Requirements of the operator	11
3	Product identification	12
3.1	Structure of the type description	12
3.2	Rating plates	13
3.3	Design of the machine	14
3.4	Options	15
3.5	Ancillaries	15
3.6	Function principle	16
3.7	EC/EU declaration of conformity	17
4	Transportation and storage	18
4.1	Unpacking and checking the condition of delivery	18
4.2	Lifting and transporting	18
4.3	Storage	19
5	Installation	20
5.1	Measures after long-term storage	20
5.2	Mounting conditions	20
5.3	Reduction of oscillations and noises	20
5.4	Mounting	21
5.4.1	Level assembly on the foot	22
5.4.2	Vertical mounting on the compressor cover	22
5.5	Fit loose silencer	22
5.6	Mount the accessories	23
5.7	Connecting pipelines and hoses	23
6	Electric power connection	25
6.1	General installation regulations	25
6.2	Controls	26
6.3	Connect the motor to the mains	27
6.4	Connect the drive control to the mains	29
6.4.1	Connect integrated drive control 2FC4	29
6.4.2	Integrated drive control by third party manufacturer	29
6.4.3	Connect wall-mounted drive control 2FC4	30
6.4.4	Connect accompanying drive control from third party manufacturer	30
6.5	Connect auxiliary ventilator	31
6.6	Connecting accessories	31
6.7	Parameterising the drive control	32
6.7.1	Parameterise integrated drive control 2FC4	32
6.7.2	Parameterise wall-mounted drive control 2FC4	32
6.7.3	Parameterise accompanying drive control from third party	32

7	Commissioning	33
7.1	Measures after a long shut-down period	33
7.2	Tests during commissioning or re-commissioning	33
7.3	Check the direction of rotation	33
7.4	Sensors function check	34
7.5	Measure the acoustic emissions	34
7.6	Measure oscillations	34
8	Operation	35
8.1	Switch on	35
8.2	Switch off	35
8.3	Switch off in emergency	35
9	Troubleshooting	36
10	Maintenance	38
10.1	Maintenance	38
10.2	Repairs and complaints	38
10.3	Ordering spare parts	38
11	Decommissioning	39
11.1	Decommissioning	39
11.2	Disassembly	39
11.3	Disposal	39
12	Technical data	40
12.1	Permitted conditions for use	40
12.1.1	Installation height	40
12.1.2	Rotational speeds	40
12.1.3	Temperatures	40
12.1.4	Pressure differences	40
12.1.5	Relative humidity	41
12.1.6	Minimum distances for heat dissipation	41
12.1.7	Speed of oscillation	41
12.1.8	Accelerations	41
12.2	Electrical data	42
12.2.1	Increased operating cycle frequency	42
12.2.2	Drive control parameters	42
12.3	Weight	42
12.4	Acoustic emissions	43

1.1 Content of this document

These operating instructions:

- is part of the side-channel compressor:

Series	G-BH1N G-BH9N	
Types	2BH14	2BH15
	2BH16	2BH18
	2BH19	2BH923

- describe the safe, proper and efficient use in all phases of its service life.
- must always be available to personnel at the place of use.
- Arranged in the main sections:
 - About these instructions
 - Safety and responsibility
 - Product identification
 - Transportation and storage
 - Mounting
 - Electric power connection
 - Commissioning
 - Operation
 - Troubleshooting
 - Maintenance, repairs and spare parts
 - Decommissioning
 - Technical data





The main section on “Safety and responsibility” must always be observed. The subsequent main sections can be used as a reference and can be read independently from each other. Cross references provided must be observed.





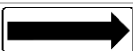

1.2 Target group

These instructions are intended for operating personnel, qualified personnel, electricians, operators and planners. See also Personnel qualifications and training [→ 9].

1.3 Explanation of the terms and symbols

In these instructions symbols and terms will be used to mean the following.

Symbol	Explanation
!	Requirement, pre-requisite
①	One-step handling instructions
1 2 3	Multi-step handling instructions
✓	Result
[→ 54]	Cross reference with page reference
	Additional information, tips
	Direction of rotation arrow
	Direction of conveyance arrow
	Collect electrical or electronic equipment separately, do not dispose of it via the residual waste bin
	General warning sign (warning of risk of injury)

Symbol	Explanation
	G-BH1N G-BH9N can start without warning
	Electrical voltage warning
	Hot surface warning
	Disconnect prior to maintenance or repair
	Earth prior to use
	Observe the instructions

Term	Explanation
Plant	Part provided by the user in which the G-BH1N G-BH9N is installed
G-BH1N G-BH9N = Side-channel compressor	Ready to connect vacuum pump/compressor for the generation of a vacuum and/or overpressure. The side-channel compressor consists of a compressor and drive, as well as other accessories where applicable.
Drive	Asynchronous motor and drive control, where applicable
Side-channel	Compression principle
Compressor	Mechanical part for side-channel compressor without drive
Single-stage	Compressor part with a compressor stage
Two-stage	Compressor part with two compressor stages operated in series. Generates higher pressure difference.
Twin-flow	Compressor part with two compressor stages operated in parallel. Generates higher volume flow.
Inner chamber of the compressor	Chamber filled with material to be compressed
Impeller	Rotating component for generating pressure within the inner chamber of the compressor
Gas inlet	Position for gas inlet
Gas outlet	Position for gas outlet
Substructure	Mounting plate, base frame or foundation on which the G-BH1N G-BH9N is constructed
Elastic / rigid	When the lowest normal frequency of the system, consisting of the G-BH1N G-BH9N and substructure, is less than 25% above the rotary frequency of the G-BH1N G-BH9N per measurement direction, then the substructure is considered to be rigid. All other substructures are considered to be elastic.
Assembly environment	Space in which the G-BH1N G-BH9N is set up and operated (this may differ from the suction environment)
Suction/discharge environment	Chamber from which the media to be conveyed is suctioned or in which the media to be conveyed is expelled (this may differ from the assembly environment)
Reference conditions	<ul style="list-style-type: none"> ▪ Ambient temperature and suction temperature: +15°C (+59°F) ▪ Ambient pressure: 1013 mbar abs. (14.7 psi abs.) ▪ Conveyed media: air ▪ Speed: 3600 min⁻¹ (60 Hz) in continuous operation ▪ Maximum pressure difference according to rating plate ▪ Horizontal assembly

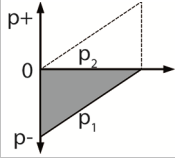
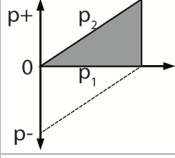
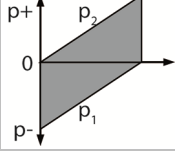
Term	Explanation	
Volume flow	Volume of air or gas that is conveyed per unit of time	
Vacuum operation	Operation with - pressure at gas inlet $p_1 < p_{\text{atm}}$. and - pressure at gas outlet $p_2 = p_{\text{atm}}$.	
Compressor operation	Operation with - pressure at gas inlet $p_1 = p_{\text{atm}}$. and - pressure at gas outlet $p_2 > p_{\text{atm}}$.	
Mixed operation	Operation with - pressure at gas inlet $p_1 < p_{\text{atm}}$. and - pressure at gas outlet $p_2 > p_{\text{atm}}$.	
Reverse operation	Operation with change in direction of rotation without intermediate standstill	
Mobile operation	Non-stationary operation	
Anti-clockwise operation (standard)	The direction of rotation is anti-clockwise when facing the compressor cover	
Clockwise operation	The direction of rotation is clockwise when facing the compressor cover	
Reverse operation	Operating while the machine runs in the direction of rotation opposite to clockwise or anti-clockwise operation	
Drive control 2FC	Device for regulating speed of G-BH1N G-BH9N. The drive control can be mounted close to the motor (wall assembly) or integrated into the G-BH1N G-BH9N.	
Drive control by third party manufacturer	A drive control purchased by the operator must only be assembled adjacently (e.g. wall assembly)	

1.4 Changes in comparison to the previous version

Changes compared with version 11.2020

- EC/EU declaration of conformity [→ 17]
- Mounting [→ 21]

1.5 Other valid documents

In addition to these instructions consider the following documents:

Document	Purpose
Data sheet	Technical data of the G-BH1N G-BH9N
Repair Manual	List of spare parts and description of the repair steps
Operating manual for drive control *	Information regarding the safe, correct handling of the drive control in all phases of its life.
Assembly instructions *	Description of the assembly of the manufacturer's accessories
Supplier documentation *	Operating manual and further documentation of the supplier's components

*according to the model option or accessories

The manufacturer is not liable for damage caused by the failure to observe these instructions and the related documents [→ 6].

2.1 Explanation of warning signs

Warning sign	Explanation
⚠ DANGER	Danger that failure to observe the measures could lead to death or serious physical injuries.
⚠ WARNING	Danger that failure to observe the measures could lead to death or serious physical injuries.
⚠ CAUTION	Danger that failure to observe the measures could lead to minor physical injuries.
NOTICE	Danger that failure to observe the measures could lead to material damage.

2.2 Correct use of the equipment

The G-BH1N | G-BH9N:

- is a machine that is optimised for continuous operation used to generate a vacuum or pressure
- can be used inside buildings, outside and in dusty or damp environments. The protection class is indicated on the rating plate [→ 13].
- Can deliver the following conveyed media:
 - Air and air/gas mixtures that are non-explosive, non-combustible, non-abrasive and non-toxic with a relative humidity of up to 100 % without condensation forming
 - Dusts $\leq 10 \mu\text{m}$ (at least filter class G1 according to EN779) without moisture and solid matter
- should only be used within the limits defined in this documentation:
 - Mounting conditions [→ 20]
 - Permitted conditions for use [→ 40]
 - Electrical data [→ 42]
- only operate when fully assembled and in a technically perfect condition.

Other operating conditions must be agreed with the manufacturer.

2.3 Unauthorised operation

It is forbidden to:

- Operating in a potentially explosive area (ATEX).
- Connecting to a potentially explosive area (ATEX).
- Transporting explosive, flammable, aggressive, unstable, oxydative or poisonous materials.
- Using non-commercial facilities without making adjustments for the additional requirements.
- Operating in reverse with sudden/abrupt changes in the direction of rotation.
NOTICE! This results in high drive loads and alternating stresses. The machine can be destroyed.
- Use in areas with ultrasound and ionising or non-ionising radiation.
- Operating outside of the limits defined in this document:
 - Mounting conditions [→ 20]
 - Permitted conditions for use [→ 40]
 - Electrical data [→ 42]

2.4 Working in a safety-conscious manner

Work at a standstill and de-energised **Work on running or energised vacuum pumps/compressors can lead to serious injuries due to body parts being drawn in or crushed or death due to electric shock.**



- ① Work on the G-BH1N | G-BH9N at a standstill only and in a de-energised condition.
- ! With G-BH1N | G-BH9N with drive controller, the drive controller continues to be under current after switching off due to the intermediate circuit voltage, which is reduced only slowly
- 1. After switching off **wait at least 3 min.**
- 2. Before opening the drive control, ensure that it is de-energised.

Negative/overpressure and ejected media **Pressures and ejected media can cause serious injuries.**

- 1. Depressurise the system before starting work on the G-BH1N | G-BH9N.
- 2. Check that all components are depressurised.
- 3. Check that no media can escape.

Screw connections **Screws can damage the thread when screwed in repeatedly. This can cause screwed parts to become loose and lead to severe injuries.**

- 1. Replace damaged screws.
- 2. Insert screws into the open thread by hand.
- 3. Afterwards, use a screwdriver to tighten the screws.

Hot surfaces **During operation and after decommissioning, contact with hot surfaces can lead to burns.**



On the G-BH1N | G-BH9N, temperatures during operation can reach **160°C** [320°F]. On the 2BH1...-2, 2BH1800-AK16-ZN00, 2BH1800-AK26ZN00 type, temperatures during operation can reach **200°C** [382°F].

- 1. Do not touch hot surfaces during operation.
- 2. Keep hot surfaces clear of highly inflammable materials.
- 3. Allow the G-BH1N | G-BH9N to cool after shutting it down.

Not fully assembled or damaged **Operation with exposed or damaged parts can lead to serious injuries due to body parts being drawn in and severed or crushed.**

- 1. Replace damaged parts prior to beginning operation.
- 2. Re-attach safety and protective devices and put them back into operation immediately after completion of work.
- 3. The G-BH1N | G-BH9N should only be put into operation when fully assembled.

Changes, additions and conversions **Changes, additions and conversions may lead to unforeseeable risks and thus to serious injuries or death.**

Modifications, additions and conversions not described in the general documentation are the sole responsibility of the operator.

Only use original parts or parts and auxiliary materials (grease, sealant) recommended by the manufacturer.

Keep all notices attached to the G-BH1N | G-BH9N in a clearly legible condition:

- Labelling of connections
- rotation arrows
- Rating plate
- Warning signs

2.5 Requirements for personnel

2.5.1 Personnel qualifications and training



NOTICE

Voiding of the warranty!

Repairs carried out by untrained and unauthorised repair personnel during the warranty period can result in the voiding of the warranty.

- ① Repairs during the warranty period should be carried out only by trained and authorised personnel.



All those who will work on the G-BH1N | G-BH9N must have read and understood these instructions and the related documents [→ 6].

Personnel in training may only work on the G-BH1N | G-BH9N under supervision of personnel who have the **required knowledge**.

Only personnel with the following knowledge may carry out the work described in these instructions:

Work task	Personnel	Required knowledge
Transportation, storage	Shipper, dealer, fitter	<ul style="list-style-type: none"> ▪ Safe handling with lifting gear such as hoists and fork lift trucks
Assembly, start-up, correcting faults, shut down, dismantling	Fitter	<ul style="list-style-type: none"> ▪ Safe handling of tools ▪ Laying and connecting pipes and hoses ▪ Mounting mechanical components ▪ Knowledge of vacuum pumps and compressors
Working on the electrical system	Electrician	<ul style="list-style-type: none"> ▪ Understanding and safe implementation of circuit diagrams ▪ Lay and connect electrical lines ▪ Connection of electrical machines, switches, sensors, circuit breakers ▪ Analysing and testing electrical systems ▪ Assessing the effectiveness of electrical protection measures
Parameterising the drive control	Operating personnel, electricians	<ul style="list-style-type: none"> ▪ Knowledge of drive controls and how to set them
Operation	Operating personnel	<ul style="list-style-type: none"> ▪ Instructions for occupational safety and for handling vacuum pumps and compressors
Maintenance Repair	Maintenance staff	<ul style="list-style-type: none"> ▪ Safe handling of tools and materials ▪ Disassemble and mount vacuum pumps and compressors ▪ Assess damage to vacuum pumps and compressors
Disposal	Disposal specialist, fitter	<ul style="list-style-type: none"> ▪ Decontaminating polluted materials ▪ Re-use of materials and substances ▪ Correct and environmentally-friendly disposal of materials and substances

2.5.2 Personal protective equipment

 **WARNING**

Danger of crushing and cutting!

Crushing and cutting of body parts due to sharp edges or falling parts on the open G-BH1N | G-BH9N.

1. Wear protective gloves, safety footwear and safety goggles for all assembly and disassembly, troubleshooting and maintenance work.
2. In addition, wear head protection for transportation and overhead work.

 **WARNING**

Risk of injury!

Serious injuries due to body parts and hair being sucked or drawn in (vacuum) or due to projected particles (pressure).

1. Wear eye protection and tight clothes for all work when in operation.
2. Wear a hair net for long hair.
3. Remove jewellery and rings.

 **WARNING**

Hearing damage!

Hearing damage due to time spent in noisy area under adverse operating conditions or due to noise caused by conveyed media being discharged from the gas outlet or piping.

- ① Wear ear protection when remaining in the excessive noise area.

2.6 Requirements of the operator



⚠ WARNING

Destruction due to bursting or exploding!

Any machine that is operated at a pressure or speed that is beyond that which is permitted can explode or burst and cause serious injuries due to parts flying off and conveyed media being suddenly ejected.

1. The operator must ensure that the pressure differences [→ 40] that affect G-BH1N | G-BH9N are not exceeded.
2. The operator must ensure that the revolutions [→ 40] are not exceeded.

⚠ WARNING

Risk of injury!

As the G-BH1N | G-BH9N is not air-tight, conveying material other than air can lead to severe or fatal injuries (e.g.: asphyxiation, burns).

- ① Adhere to the safety measures described for the material being conveyed (if necessary, check leakage rates and provide for gas monitoring or forced ventilation).

The operator ensures that:

- All work on the G-BH1N | G-BH9N is carried out by:
 - personnel that have the necessary Personnel qualifications and training [→ 9]
 - personnel that have been sufficiently informed of these instructions and all related documents [→ 6]
- Assignment, responsibility and supervision of personnel is regulated.
- The content of these and locally applicable instructions are always available to personnel.
- Personnel are informed of possible dangers related to conveyed material and the necessary safety precautions.
- All local and plant-specific safety measures are complied with:
- The free drawing in or emission of the conveyed media does not place any personnel in danger.
- Dangers due to electrical energy are not possible.

3.1 Structure of the type description

2BH1

2BH1 4 0 0 - 1 A K 1 6 - Z



2BH9

2BH9 2 3 0 0 - 1 A A Q R 7 - B A - Z



3.2 Rating plates

Rating plate for compressor (item 2000, [→ 14])

The permitted operating conditions are indicated on this rating plate.

		Gardner Denver		A G-BH . N 2BH ... B ... -Z		N		M	
		C iN xxxxxxxx xxx/xxxx							
		Hz	kW	r.p.m.	V	A	P.F	Δp [mbar]	IEC/EN 60034
50 Hz		E	F ₁	K	G	H ₁	J	p ₁ p ₂	IP xx
60 Hz									
Drive control									Q
									Made in Germany

Rating plate for the motor (item 2001, [→ 14])

The rating data as stipulated in IEC 60034-1 is specified on this rating plate.

		Gardner Denver		C Motor		B XXX-XXXX-Z		S	
		BN XXX		XX XXX/XXXX					
		Hz	[kW]	r.p.m.	V	A	P.F.	nom. eff.	D CODE
50 Hz IEC		E	F ₂	K	G	H ₂	J	O	R
60 Hz IEC									
länderspezifisch									Q
									Made in Germany

- | | |
|--|--|
| <ul style="list-style-type: none"> A Series B Type C Serial number, month and year of manufacture D Machine type, protection class, thermal class E Frequency F₁ Maximum output during continuous operation F₂ Measured power output according to IEC 60034-1 G Voltage H₁ Maximum current during continuous operation (setting for overcurrent protection) H₂ Rated current according to IEC 60034-1 J Power factor K Rated rpm | <ul style="list-style-type: none"> p Pressure differences p₁ Values with a negative sign apply to vacuuming and vacuum operations p₂ Values with a positive sign apply to pressure and compressor operations M Manufacturer's recommendations (optional) N Customer information (optional) O Nominal efficiency Q Serial number / year of manufacture as data matrix code R Ratio of breakaway starting current to apparent power S DoE registration with family type number and manufacturer's label T UL / CSA recognition mark + file number U NEMA rating |
|--|--|

3.3 Design of the machine

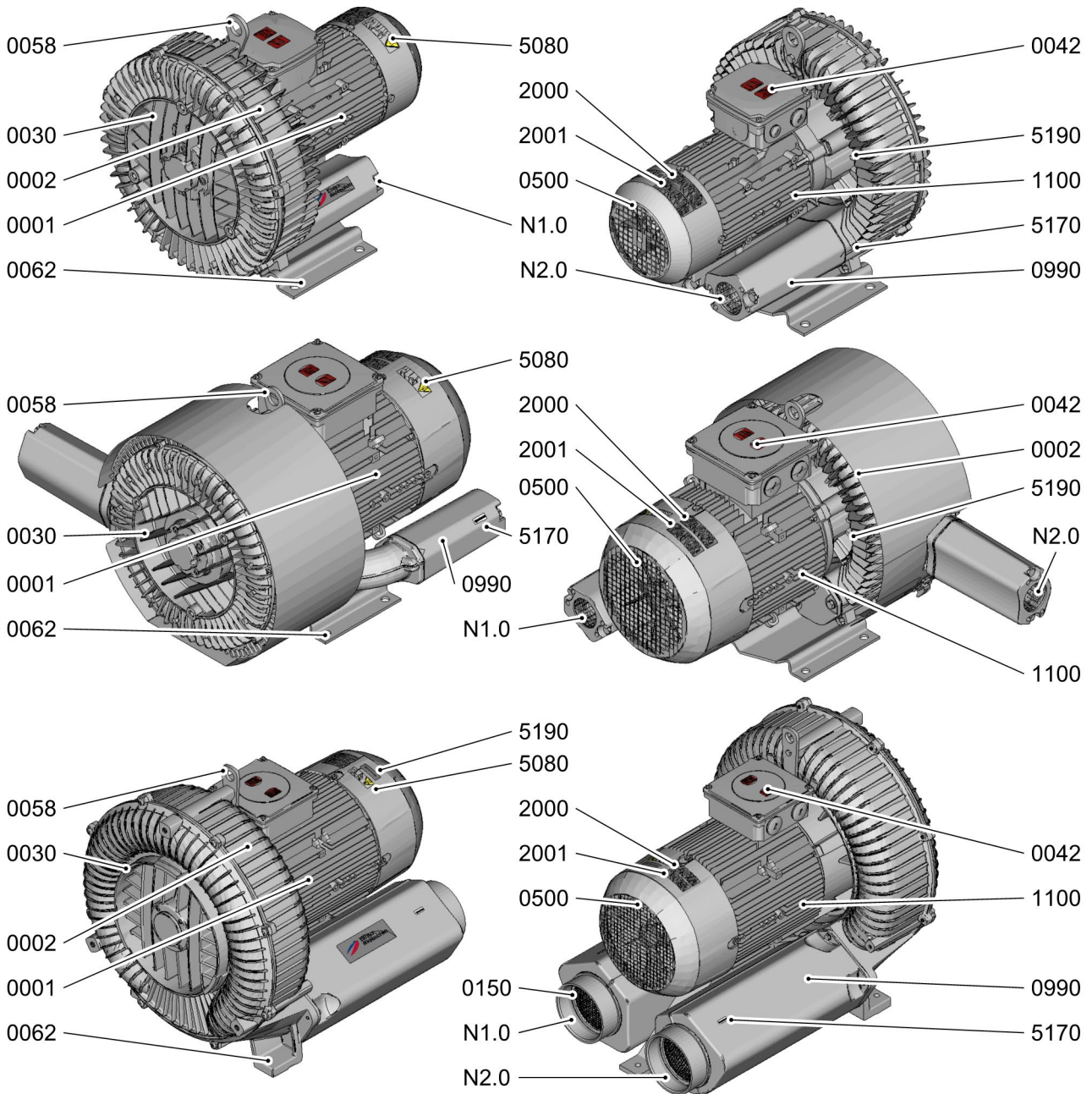

- 0001 Drive motor
- 0002 Compressor housing
- 0030 Compressor cover
- 0042 Junction box
- 0058 Eye bolt/lifting attachment
- 0062 Foot
- 0150 Protective grid
- 0500 Fan guard
- 0990 Silencer

- 1100 External earth connection
- 2000 Compressor rating plate
- 2001 Motor rating plate
- 5080 Adhesive label with CE marking
- 5170 Direction of conveyance arrow
- 5190 Direction of rotation arrow
- N1.0 Gas inlet
- N2.0 Gas outlet

3.4 Options

The G-BH1N | G-BH9N can be delivered with the following options

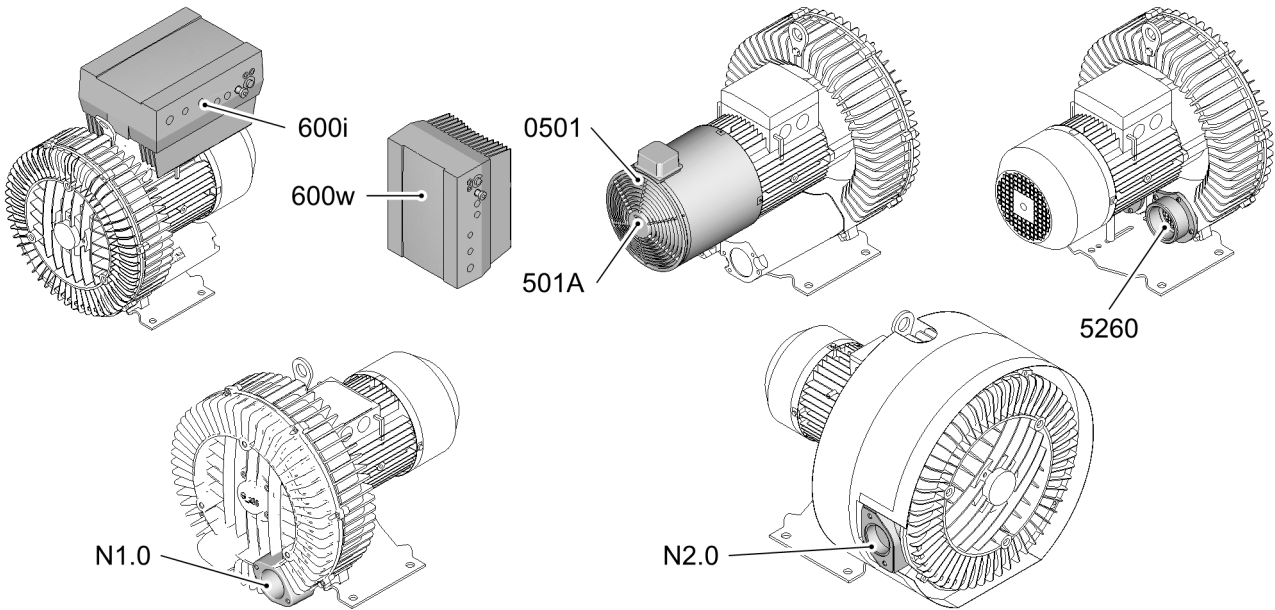

600i Integrated drive control 2FC4

600w Wall-mounted drive control 2FC4

0501 Auxiliary ventilator

501A Direction of rotation arrow, auxiliary ventilator

5260 Gas outlet and/or gas inlet without silencer with flange

N1.0 Cover side gas inlet without silencer and without flange

N2.0 Side gas outlet without silencer and without flange

3.5 Ancillaries

The following original accessories are available from the manufacturer

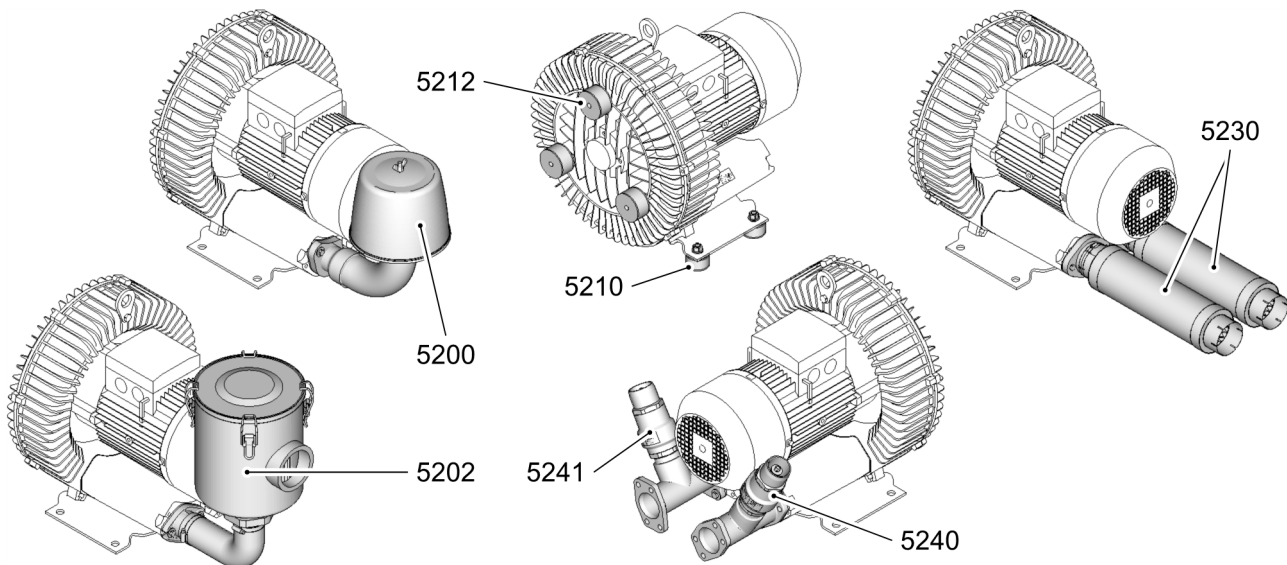

5200 Suction filter

5202 In-line filter

5210 Foot-mounted spring elements

5212 Cover-mounted spring elements

5230 Additional silencers

5240 Pressure limiting valve

5241 Vacuum shut-off valve

3.6 Function principle

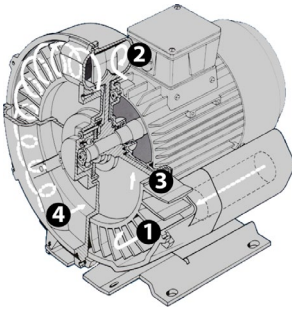

The side-channel compressor consists of a drive (motor) and a compressor part in which an impeller rotates contact-free in the side-channel.

Side-channel compressors can be used as a vacuum pump or are used as the compressor (observe Correct use of the equipment [→ 7]).

As soon as the motor is switched on, conveyed media is suctioned via the gas inlet (1).

When it enters the side-channel the conveyed media is accelerated in the direction of rotation by the blades of the rotating impeller (3).

The centrifugal force presses the conveyed media to the inner wall of the side-channel (2). From there, the conveyed media is supplied to the impeller blades again.

With every renewed entry of the conveyed media into the impeller, it gains kinetic energy and the pressure increases.

The cross section of the side-channel is limited at the interrupter.

In this manner, the conveyed media is stripped from the impeller blades and expelled via the gas outlet (4).

3.7 EC/EU declaration of conformity

Manufacturer: Gardner Denver Deutschland GmbH
 Industriestraße 26, 97616 Bad Neustadt, Germany

Representative for the compilation of technical documents: Holger Krause, Gardner Denver Deutschland GmbH
 Industriestraße 26, 97616 Bad Neustadt, Germany

Designation of the machine: Compressor/vacuum pump

Series	G-BH1N G-BH9N	
Types	2BH14	2BH15
	2BH16	2BH18
	2BH19	2BH923

**Gardner
Denver**

The manufacturer bears sole responsibility for issuing this declaration of compliance. The machine described above complies with all applicable harmonisation legislation of the Community:

2006/42/EC, OJ L 157, 9.6.2006	Directive 2006/42/EC of the European Parliament and of the Council of 17 May 2006 on machinery, and amending Directive 95/16/EC
2014/30/EU *, OJ L 96, 29.3.2014	Directive 2014/30/EU of the European Parliament and the Council of 26 February 2014 on the harmonisation of the laws of the Member States relating to electromagnetic compatibility

* Only with integrated drive control 2FC4

2011/65/EU, OJ L 174, 1.7.2011	Directive 2011/65/EU of the European Parliament and of the Council of 8th June 2011 on the restriction of the use of certain hazardous substances in electrical and electronic equipment
---	--

harmonised standards and other technical specifications on which the declaration of compliance is based:

EN 1012-1:2010	Compressors and vacuum pumps - Safety requirements - Part 1: Compressors
EN 1012-2:1996 +A1:2009	Compressors and vacuum pumps - Safety requirements - Part 2: Vacuum pumps
EN ISO 12100:2010	Safety of machinery - General principles for design - Risk assessment and risk reduction (ISO 12100:2010)
EN 60204-1:2006/ A1:2009/ AC:2010	Safety of machinery; electrical equipment for machinery part 1: General requirements IEC 60204-1:2005 (amended)
EN 60034-1:2010/ AC:2010	Rotating electrical machines - Part 1: Rating and performance IEC 60034-1:2010 (amended)

Signed for and on behalf of: Gardner Denver Deutschland GmbH

Bad Neustadt, 16.12.2020

(Place and date of issue)



Caroline Seit, Operations/Authorised signatory
(Name and function)



Markus Kopf, Manager Engineering
(Name and function)

664.00165.40.000

4.1 Unpacking and checking the condition of delivery

The G-BH1N | G-BH9N is secured onto a pallet and protected by a cardboard box for delivery.

1. Remove the packaging, except for the transport protection on the connection openings.
2. Check the delivery for transport damage.
NOTICE! Report any transport damage to the manufacturer immediately.
3. Check that the delivery matches the order.
4. Remove fastening screws on the foot (item 0062, [→ 14]).
NOTICE! The transport spring elements attached to the machine cannot be used for the installation as they may have been damaged during transport. Dispose of transport spring elements.
5. Dispose of packaging material in accordance with the valid local regulations.

4.2 Lifting and transporting

WARNING

Danger of crushing and cutting!

Danger of crushing and cutting of body parts due to tipping or falling loads during transportation.

1. Only transport G-BH1N | G-BH9N in a horizontal position (exception: 2BH1943).
2. The load-bearing capacity of the lifting gear and load-handling equipment must correspond to the mass [→ 42].
3. Secure against tipping over or falling.
4. Do not remain under supported loads.
5. Set up the G-BH1N | G-BH9N on a stable and level surface.

NOTICE

Mechanical damage!

G-BH1N | G-BH9N can be damaged during transportation.

- ! The G-BH1N | G-BH9N is designed for transport with a crane or forklift.
- ① The G-BH1N | G-BH9N should not be exposed to impacts and blows during transportation.

The type of transportation depends on the mass:

- G-BH1N | G-BH9N up to **20 kg (44 lbs) without** lifting attachment/eye bolt: Transportation by hand **NOTICE! Observe the health and safety requirements!**
- G-BH1N | G-BH9N over **20 kg (44 lbs) with** lifting attachment/eye bolt: Transportation with a crane

Transport with crane (except for 2BH1943)

- ① Remove the attached in-line filter before transporting the G-BH1N | G-BH9N.
! The G-BH1N | G-BH9N on the compressor cover (item 0030, [→ 14]) must be placed horizontally for transportation with lifting attachment (item 0058, [→ 14]).
- 1. Guide the lifting strap between the compressor housing (item 0002, [→ 14]) and the motor (item 0001, [→ 14]) through openings or on edges.
⚠ WARNING! Make sure that the lifting strap cannot slip off!
- 2. Lift the G-BH1N | G-BH9N until the lifting strap is taut.

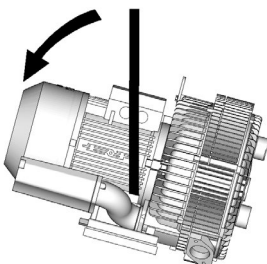

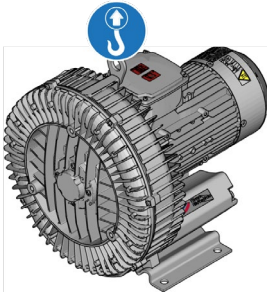

3. Tilt the G-BH1N | G-BH9N with one or two people on the foot, depending on the type.
4. Check that the eye bolt/lifting attachment is firmly fastened and retighten as necessary.
 - ✓ M8: **18 – 22 Nm** (13.3 – 16.2 ft lbs)
 - ✓ M12: **18 – 42 Nm** (13.3 – 31.0 ft lbs)
 - ✓ M16: **138 – 165 Nm** (102 – 122 ft lbs)
5. Attach the crane hook to the eye bolt/lifting attachment.
6. Attach the crane hook to the eye bolt.
7. Lifting and transporting the G-BH1N | G-BH9N.
8. Set the G-BH1N | G-BH9N down and, if necessary, secure from slipping and falling.
9. Remove the lifting device.

Transporting the 2BH1943 with a crane

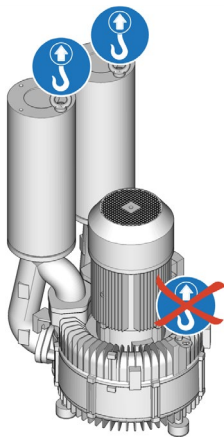

1. Screw an eye bolt into each silencer (item 0990, [→ 14]) - not included in scope of delivery.
2. Attach the crane hook to the eye bolt.
3. Lifting and transporting the G-BH1N | G-BH9N.
4. Set the G-BH1N | G-BH9N down and, if necessary, secure from slipping and falling.
5. Remove the lifting device.

4.3 Storage

NOTICE

Mechanical damage and corrosion!

Failure to adhere to the storage conditions can lead to mechanical damage and corrosion, as well as shorten the grease service life.

1. Adhere to storage and standstill conditions.
2. The maintenance intervals of the ball bearings (Maintenance [→ 38]) become shorter as the time of storage increases.

1. Connect all suction vents so that no dirt or solid particles can enter.
2. Turn the rotor once per year so as to avoid permanent standstill marks.

Storage conditions	Permitted values	
Ambient pressure	Atmospheric	
Composition of the environment	Dry, dust-free environment (relatively humid < 60%)	
Ambient temperature	-20°C to +40°C	-4°F to +104°F
Static loads	None	
Abrupt impacts	None	
Speed of oscillation V_{eff}	<1.5 mm/s	<0.059 in/s

5.1 Measures after long-term storage

Replace ball bearings and radial shaft seal

! When the length of storage until assembly is exceeded by **4 years** for the storage conditions provided in Storage [→ 19].

1. Replace the rolling bearing.
2. Clean adjacent bearing areas for open ball bearings and re-grease.
3. Replace and grease the radial shaft seal.

If the bearing conditions vary (Storage [→ 19]), a reduced ball bearing service life is to be expected.

Measuring the motor insulation resistance

- ① Measure the insulation resistance of the motor at 500V DC voltage between the conductors of the main circuit and protective conductive system.
 - ✓ Value $\geq 1 \text{ M}\Omega$: no measures necessary.
 - ✓ Value $< 1 \text{ M}\Omega$: Dry winding.

5.2 Mounting conditions

For safe operation, comply with the following installation conditions

- Always secure the G-BH1N | G-BH9N to an even ($\pm 0.5 \text{ mm}$ [0.197]) assembly surface or base frame using screws. The dimensions and load-bearing capacity must be designed for the G-BH1N | G-BH9N.
- When installing outdoors, take protective measures against the effects of weather.
- When installing in enclosed spaces, ensure that there is sufficient ventilation. For conveyed media other than air, leaks from the G-BH1N | G-BH9N must be taken into account (e.g. forced ventilation, gas monitoring).
- No exhaust air from other machines in the suction area of the motor fan.
- External oscillations, abrupt loads and accelerations are not permitted.
- External mechanical loads are not permitted on the G-BH1N | G-BH9N and its attachments (e.g. piping without a support, climbing the G-BH1N | G-BH9N and its attachments).
- If there is a risk of condensation forming in the interior of the G-BH1N | G-BH9N, take protective measures (e.g. heating, moisture separators).

5.3 Reduction of oscillations and noises

Noise emissions and vibrations can be reduced by the following measures.

- Do not set up the G-BH1N | G-BH9N in set-up areas that conduct or radiate sound.
- Equip installation surfaces with intermediate layers of noise damping material.
- Use additional silencer (item 5230, [→ 15]).
- When mounting horizontally, use spring elements on the foot (item 5210, [→ 15]).
- It is recommended to flexibly set up the G-BH1N | G-BH9N on springs elements.

5.4 Mounting

The following installation positions are permitted by the manufacturer:

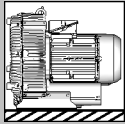
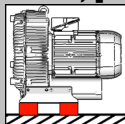
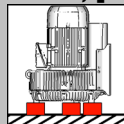
Type	Without spring elements	With spring elements	
		Item 5210, [→ 15] 	Item 5212, [→ 15] 
2BH1 2BH9 with drive controller	✗	✓	✓ ^{1/2}
2BH14..-1A.2. 2BH141.-1H...	✓	✓	✓ ^{1/2}
2BH14..-1A.1.	✗	✓	✓ ^{1/2}
2BH15..-1A.0. 2BH15..-1A.1. 2BH15..-1A.2.	✓	✓	✓ ^{1/2}
2BH15..-1A.3. 2BH151.-1H...	✗	✓	✓ ^{1/2}
2BH16..-1A.0. -1A.1. 2BH16..-1A.3. -1A.6. 2BH164.-1G.3. -1G.4. 2BH164.-1G.5.	✓	✓	✓ ^{1/2}
2BH16..-1A.2. 2BH161.-1H...	✗	✓	✓ ^{1/2}
2BH18..-0A... 2BH18..-1.... -2.... 2BH181.-0H.2. -0H.3. 2BH184.-0J.2. -0J.3.	✓	✓	✓ ^{1/2}
2BH181.-0H.4. 2BH184.-0J.4.	✗	✓	✓ ^{1/2}
2BH19..-1A.0. -2A.0. 2BH191.-1H.4. 2BH1940-1....	✓	✓	✓ ^{1/2}
2BH19..-1A.1. -2A.1. 2BH19..- 1A.2. -2A.2. 2BH19..-1A.3. -2A.3. 2BH191.-1H.1. -1H.2. 2BH191.-1H.3.	✗	✓	✓ ^{1/2}
2BH1943	✗	✗	✓ ^{1/2}
2BH9	✗	✓	✓ ^{1/2}

¹ Not a function of the condensate drain hole L12

² Conveying moisture and condensate along with the other material reduces the service life of the rolling bearings

5.4.1 Level assembly on the foot

1. Mark the fixing points through the holes in the foot (item 0062, [→ 14]) or by referring to the dimensional drawing.
2. Lift the G-BH1N | G-BH9N away and drill the holes for the fixing points.
3. Place the G-BH1N | G-BH9N with the foot in assembly position.
4. Screw the foot to all anchorage holes with fastening elements.
 - ✓ M8 steel (8.8 according to ISO 898-1): **18 – 22 Nm** (13.3 – 16.2 ft lbs)
 - ✓ M10 steel (8.8 according to ISO 898-1): **35 – 42 Nm** (25.8 – 31.0 ft lbs)
 - ✓ M12 steel (8.8 according to ISO 898-1): **58 – 70 Nm** (42.8 – 51.6 ft lbs)

5.4.2 Vertical mounting on the compressor cover

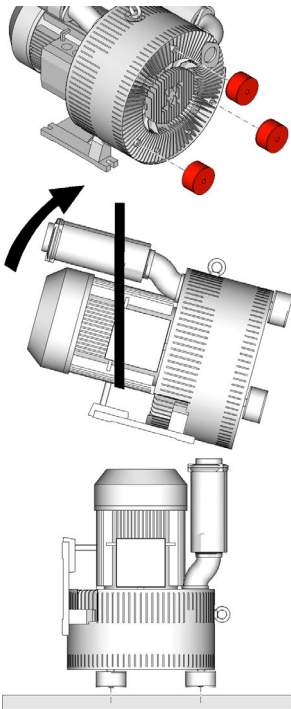

- ! Spring elements (item 5212, [→ 15]) must be used in order to mount vertically on the compressor cover (item 0030, [→ 14]).
1. Mark the threaded holes for the cover position (item N8.8, [→ 14]) based on the dimensional drawing.
 2. Drill the holes for the fixing points.
 3. Screw the threaded studs of the spring elements into the threaded holes for the cover position.
 - ⚠ **CAUTION! Tighten securely! Tightening torque 11 - 22 Nm (8.1 - 16.2 ft lbs)**
 4. Place the lifting strap around the motor (item 0001, [→ 14]) between the compressor housing (item 0002, [→ 14]) and the sleeve.
 5. Lift the G-BH1N | G-BH9N and tilt it with **two** people onto the compressor cover.
 6. Place the G-BH1N | G-BH9N with the compressor cover in the assembly position.
 7. Screw the G-BH1N | G-BH9N to the mounting surface using the threaded hole in the spring elements and securing elements.
 - ✓ M12 steel (8.8 according to ISO 898-1): **58 – 70 Nm** (42.8 – 51.6 ft lbs)
 8. Remove the lifting device.

5.5 Fit loose silencer

! The silencers are enclosed separately for two-stage and twin-flow G-BH1N | G-BH9N and have to be installed.

- ① Remove transport protection.

2BH1/9 (without 2BH1810)

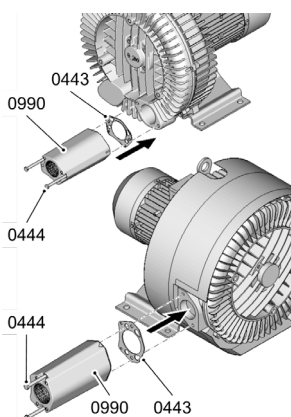

1. Check that the seal (0433) is securely fastened to the silencer (0990) and re-position seal, if necessary.
2. Position the silencer on the compressor cover or centre body
 - ✓ Observe the alignment of the silencer!
3. Screw in the silencer using the screws (0444).
 - ✓ M6: **7.5 – 9.0 Nm** (5.55 – 6.65 ft lbs)
 - ✓ M8: **18 – 22 Nm** (13.3 – 16.2 ft lbs)

2BH1810 with manifold (0047)

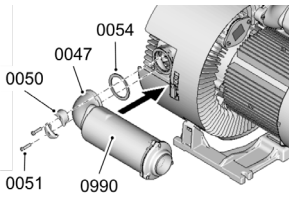

1. Check that the seal (0054) is securely fastened to the silencer (0990) and re-position seal, if necessary.
2. Position silencer on centre body with attached flange.
 - ✓ Observe the alignment of the silencer!
3. Screw in the silencer using the threaded rods (0050) and screws (0051).
 - ✓ M8: **18 – 22 Nm** (13.3 – 16.2 ft lbs)

2BH1810 with double nipple (0447)

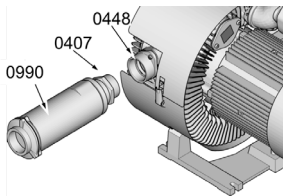

- ① Screw the silencer (0990) with double nipple into the flange (0448).
 - ✓ **40 – 70 Nm** (30.0 – 51.5 ft lbs)

5.6 Mount the accessories

- ① Mount accessories according the instruction manual supplied with the respective accessory.

5.7 Connecting pipelines and hoses

⚠ WARNING

Risk of injury due to uncased gas outlet and gas inlet!
Serious injuries to body parts, drawing in of hair or projected hot conveyed media or particles.

! Operation without piping and/or without silencers (free suction and/or free blowing pressure side) is solely permitted if the following measures are taken:

1. Install a protective grid (option C25) in the gas outlet and gas inlet.
2. Take protection measures on the gas inlet to prevent hair from being sucked in.
3. On the gas outlet, secure the danger area from hot conveyed media and projected particles with deflection plates or a collection basket.
4. Provide sound protection measures.



⚠ WARNING

Risk of burns due to temperatures of up to approx. 160°C/200°C [320°F/392°F]!

Contact with hot surfaces, pipes and hoses, can lead to burns.

1. Fit pipes and hoses with sufficient distance from highly inflammable materials (e.g. wood, plastic).
2. Cover hot surfaces, such as pipes and hoses, with protection (e.g. perforated metal cover or wire covering) or isolate them.
3. Hot surfaces, such as pipes and hoses, that do not have their own safeguard, are supplied with warning signs.

NOTICE

Pressure loss due to reduced cross section of the pipes and hoses!

- ① As possible, make the cross section of the pipes and hoses the same length or longer than the connections of the G-BH1N | G-BH9N.

The conveyed material is sucked in via the gas inlet (item N1.0, [→ 14]) and discharged via the gas outlet (item N2.0, [→ 14]). The direction of conveyance of the conveyed media is marked by a conveyance arrow (item 5170, [→ 14]).

The G-BH1N | G-BH9N can be fitted with pipes or hoses.

Connection dimensions and tightening torques for gas inlet (item N1.0) and gas outlet (item N2.0, [→ 14])

Type	Pipe thread			Direct connection			Hose connection
	ISO 228	ANSI/ASME B 1.20.1	[Nm (ft lbs)]	Opening [mm (in)]	Distance between screws [mm (in)]	[Nm (ft lbs)]	[mm (in)]
2BH14	G 1½	---	40 – 70 (29.5 – 51.6)	Ø 46 (1.81)	Ø 72 (2.84)	M6: 7,5 – 9,0 (5.55 – 6.65)	Ø 50 (1.97)*
2BH15 2BH16	G 2*	NPT 2-8*	58 – 90 (42.8 – 66.4)	Ø 55 (2.17)	Ø 83 (3.27)	M8: 18 – 22 (13.3 – 16.2)	Ø 50 (1.97)* Ø 60 (2.36)*
2BH18	G 2½	NPT 2½-8*	NPT 2½-8	---			Ø 76 (2.99)*
2BH1900 – 2BH1940	G 4*	NPT 4-8*	100 – 165 (73.8 – 122)	Ø 100 (3.94)	Ø 150 (5.91)	M12: 58 – 70 (42.8 – 51.6)	Ø 115 (4.53)*
2BH1943	G 5*	NPT 5-8*	138 – 200 (102 – 147)	Ø 130 (5.12)	Ø 210 (8.27)	M16: 138 – 165 (102 – 122)	Ø 150 (5.91)*
2BH92300	G 5	---	138 – 200 (102 – 147)	---			Ø 150 (5.91)
	* Option C28	* Option C29					* Option C41

! On delivery, all connection openings are closed with a transport protection. This prevents foreign objects from entering.

1. Remove the transport protection from the connection openings.
2. For impurities in the conveyed media, fit a filter (accessories) in the suction line.
3. Install a check valve if the conveyed media can flow through the G-BH1N | G-BH9N while at a standstill (external drive through conveyed media).
4. **NOTICE! When connecting pipe threads, secure the connection points against turning.**
5. Connect the pipe or hose of the system pressure line to the gas outlet (item N2.0, [→ 14]).
6. Connect the pipe or hose of the system suction line to the gas inlet (item N1.0, [→ 14]).
7. **NOTICE! When connecting pipe threads, check the silencer for leaks and replace the seal if necessary.**

6.1 General installation regulations



DANGER

Lethal electric shock on the housing due to the air gap being too small!

! Air gaps between non-insulated, voltage active components and the earth must be at least **5.5 mm** [0.217 in] to one another (for a measured voltage of $U_N \leq 690$ V).

1. Avoid projecting cable ends.
2. Ensure electrical connections are durably resilient.



DANGER

Lethal electric shock due to contact voltage on the housing!



1. Implement protection from contact voltage according to IEC 60204-1. Use the earth connection in the junction box (equipotential bonding protection). For operating the drive control, observe the manufacturer's operating instructions for the drive control.
2. If necessary, connect the equipotential bonding bar to the outer earth connection (item 1100, [→ 14]).
3. Keep the junction box free of foreign objects, dirt and moisture.
4. Seal junction box lid and cable feed openings so that they are dust and water tight.

NOTICE

Destruction of the drive!

Incorrect operation or incorrect control can destroy the drive.

1. The G-BH1N | G-BH9N is equipped with an **asynchronous motor**.
2. Operating on a grid with a non-earthed start point is not permitted.

The electrical installation must properly fulfil the requirements of IEC 60204-1, IEC 60204-11 and IEC 61010-1.

The electrical installation must also be implemented according to the applicable national, local and plant-specific stipulations, as well as the requirements of the power supply company.

The conditions at the place of use must comply with the details on the rating plate (item 2000, [→ 13]).

The following conditions are permitted during mains operation:

- $\pm 5\%$ variation in voltage without loss of performance (range A, EN 60034-1) according to the compressor rating plate (item 2000, [→ 13])
- $\pm 10\%$ variation in voltage with loss of performance (range B, EN 60034-1) according to the compressor rating plate (item 2000, [→ 13])
- $\pm 2\%$ deviation in frequency
- Deviations are indicated on the rating plate of the compressor (item M, [→ 13])

The electrical installation must:

- Be designed in accordance with the ambient and operating conditions (ampacity)
- Be correctly attached and protected.
- Be kept away from hot surfaces.
- Be electrically isolated to a sufficient degree.

- Be constructed and fitted in such a way that the following faults do not lead to damage:
 - short circuits
 - mechanical impacts
 - power supply failures or surges
 - electromagnetic fields
 - earth connections

The electrical equipment and control must not put the protective devices of the drive system and the motor protection (e.g. PTC resistor, bimetal switch, frequency inverter current limit) out of operation.

When the power supply fails or surges, the control must prevent the G-BH1N | G-BH9N from remaining in operation or starting up.

Protective devices and switches must fulfil the failure safety conditions.

Overcurrent protection

The power supply of the motor and, if necessary, of the auxiliary ventilator must be equipped with an overcurrent protection according to IEC 60204-1, 7.2.

Set the overcurrent protection device to the maximum current (item H₁, [→ 13]).

Separator for the electrical energy supply

A separator for the electrical energy supply must be:

- Provided according to IEC 60204-1, 5.3 and 5.5.
- Clearly and visibly labelled.

6.2 Controls

Controls and instruments must be constructed and arranged in such a way that:

- They are easily visible and accessible, and can also be operated without excessive effort.
- The operator understands the functions.
- Operating faults are prevented.

A control system must correspond to ISO 12100, 4.11; IEC 60204-1, 9.4 and ISO 13849-1.

When the power supply fails, a "system with oriented failure mode" according to ISO 12100, 6.2.12.3 must be used.

Start and stop devices must be clearly marked in accordance with ISO 13850 and IEC 60417.

EMERGENCY OFF function

An EMERGENCY OFF function must be provided when a dangerous situation can occur that must be rectified manually (see ISO 12100, 6.3.5.2)

- Implement the EMERGENCY off function according to EN 418 and EN 50099.
- Implement a manual EMERGENCY OFF function according to ISO 13849-1, 5 (in particular 5.2.1).
- The stop category and colour of the EMERGENCY OFF function must correspond to ISO 13850.
- If a risk assessment determines that the normal switch can fulfil the EMERGENCY OFF function, this should be labelled accordingly.

After an EMERGENCY OFF, start-up is only possible via a deliberate, manually-triggered procedure.

Manual reset

A manual reset after a stop command must correspond to ISO 13849-1, 5.5.2 and IEC 60204-1, 9.2.5.3 and 9.2.5.4.

Start and new start

The requirements of a start and new start, must correspond to ISO 13849-1, 5.2.3.



If the G-BH1N | G-BH9N is equipped with an automatic or remote-controlled start control, it must be labelled with the sign to the left.

It is necessary to prevent an automatic or remote-controlled start during maintenance or repair.

6.3 Connect the motor to the mains

This section does not apply to G-BH1N | G-BH9N with integrated drive control 2FC4...-1 (item 600i, [→ 15]).

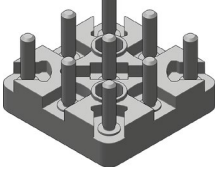
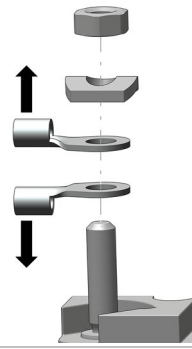
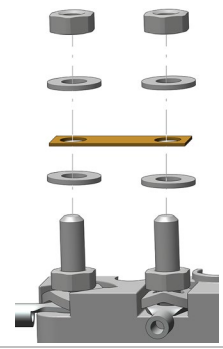
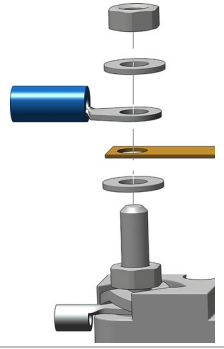
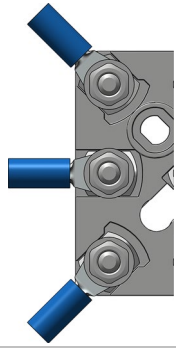
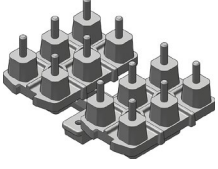
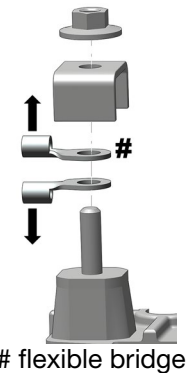
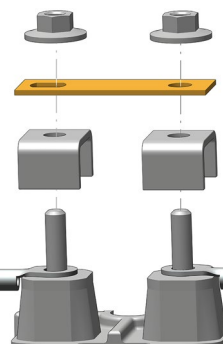
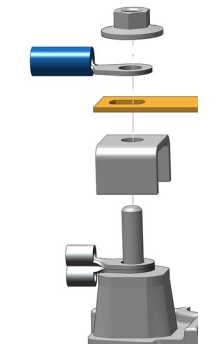
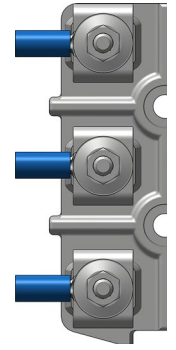
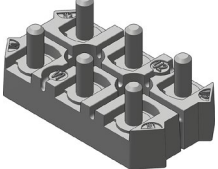
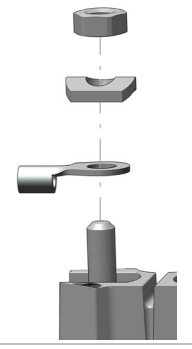
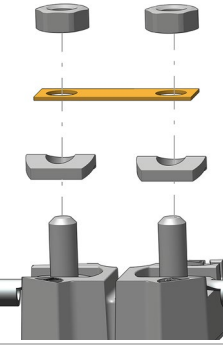
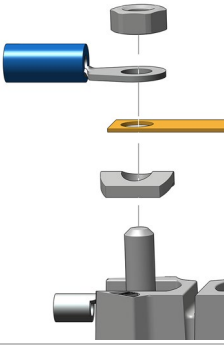
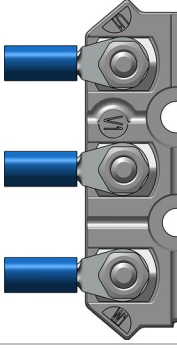
Terminal board design	Internal motor wiring		Customer connection / mains connection / plug	
	Motor connection cables	Connecting rail	Mains connection	Cable routing*
9-pole Motor type K 				
2x6-pole Motor type K 	 <p># flexible bridge</p>			
6-pole Motor type Q 				

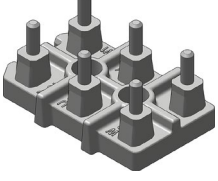
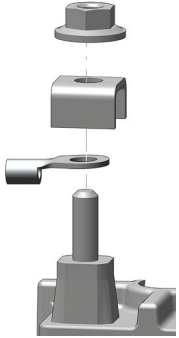
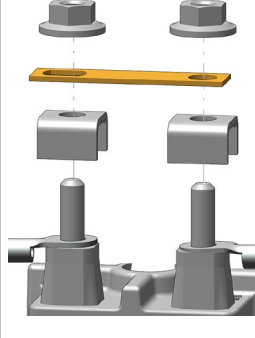
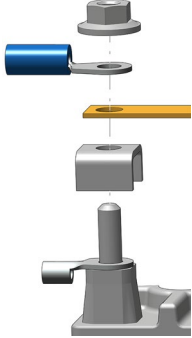
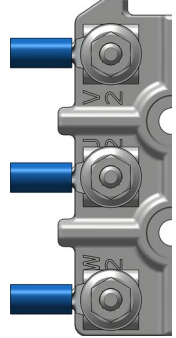
Terminal board design	Internal motor wiring		Customer connection / mains connection / plug	
	Motor connection cables	Connecting rail	Mains connection	Cable routing*
6-pole Motor type Q 				

* Install cable lugs parallel to the terminal board cases/domes!

1. Open the junction box cover.
2. Open necessary access points for cable glands.
3. Screw in or insert cable glands and secure with locknut. Screw in fit reducer, if available.
NOTICE! The cable glands and fit reducers may not lower the IP protection class.
4. With the junction box turned, check the tightening torques of the junction box screw fittings.
 - ✓ M4: **4.0 – 5.0 Nm** (2.95 – 3.70 ft lbs)
 - ✓ M5: **7.5 – 9.5 Nm** (5.55 – 7.00 ft lbs)
5. Feed the cable to be connected through the cable glands and into the junction box (item 0042, [→ 14]).
6. Attach cable lugs to cable to be connected.
7. Connect the protective cable to the designated position with the symbol to the left.
 - ✓ M4: **4.0 – 5.0 Nm** (2.95 – 3.70 ft lbs)
 - ✓ M5: **7.5 – 9.5 Nm** (5.55 – 7.00 ft lbs)
8. Attach mains connecting line and connecting rails according to the circuit diagram in the junction box (item 0042, [→ 14]).
NOTICE! Refer to figures.
 - ✓ M4: **0.8 – 1.2 Nm** (0.60 – 0.90 ft lbs)
 - ✓ M5: **1.8 – 2.5 Nm** (1.35 – 1.85 ft lbs)
9. If available, connect PTC resistor, bimetal switch and electric band heater according to the circuit diagram in the junction box (item 0042, [→ 14]). Use a PTC resistor evaluation unit to evaluate the PTC resistor.
10. Remove any unused parts (e.g. bridges, nuts) from the junction box.
11. Tighten cable glands according to manufacturer's specifications.
12. Seal off open access points for cable glands using appropriate seals.
13. Close the junction box cover.
 - ✓ M4: **4.0 – 5.0 Nm** (2.95 – 3.70 ft lbs)
 - ✓ M5: **7.5 – 9.5 Nm** (5.55 – 7.00 ft lbs)



6.4 Connect the drive control to the mains



⚠ CAUTION

Destruction of the isolation system due to excessive connection voltages!

1. The G-BH1N | G-BH9N can be operated at mains voltages ≤ 500 V on the drive control provided the permitted voltage peaks are observed.
2. Permitted voltage gradient ≤ 9 kV/ μ s.
3. $\hat{U}_{\text{Conductor-Conductor}} \leq 1500$ V, $\hat{U}_{\text{Conductor-Ground}} \leq 1100$ V.
4. Wavefront duration $t_s > 0,1$ μ s.

NOTICE

Failure to reach the pressure values due to insufficient voltages on the motor terminal board!

- ! The voltages given on the rating plate (item G, [→ 13]) apply to mains operation.
- ① For operation of the G-BH1N | G-BH9N on the drive control, the voltages given on the rating plate must be adhered to on the motor terminal board.

NOTICE

G-BH1N | G-BH9N with UL approval may not be operated in the USA without testing of the drive control by a testing agency!

- ① G-BH1N | G-BH9N must be certified by a testing agency or operated without a drive control.

Observe when operating with drive control

- The G-BH1N | G-BH9N is equipped with an asynchronous motor and must be controlled correspondingly.
- G-BH1N | G-BH9N with PTC resistor (option A11): When the PTC resistor is activated, the G-BH1N | G-BH9N must switch off.
- For G-BH1N | G-BH9N without PTC resistor, provide motor protection measures.
- Observe [→ 40] revolution limits.
- In the case of installed sensors (e.g. PTC resistor), interfering voltages may occur in the sensor wiring depending on the type of drive control.
- Observe the operating instructions of the drive control manufacturer.

6.4.1 Connect integrated drive control 2FC4

- ① Connect integrated drive control **2FC4** (item 600i, [→ 15]) according to the drive control operating instructions [→ 6].

6.4.2 Integrated drive control by third party manufacturer

NOTICE

Mechanical damage!

In the G-BH1N | G-BH9N, mounted drive controls from third-party manufacturers can overload the foot and lifting attachment or damage the bearing due to the oscillations.

- ① Only mount drive controls from third-party manufacturers adjacently.

6.4.3 Connect wall-mounted drive control 2FC4

1. Open the junction box cover of the motor (item 0042, [→ 14]).
2. Connect drive control **2FC4** (item 600w, [→ 15]) according to the related operating instructions [→ 6].
3. Close the junction box cover.

6.4.4 Connect accompanying drive control from third party manufacturer

When operating with drive controls from third-party manufacturers, observe:

- High-frequency current and voltage harmonics in the motor supply wiring can cause electro-magnetic interference. This is dependent on the type of drive control (type, manufacture, voltage supply measures).
 - Observe the EMC notes of the drive control manufacturer.
 - If necessary, use screened cables/wiring. To provide the optimum screening, the screening must be connected to the metal junction box using a large-area metal conducting fastener.
1. Open the junction box cover of the motor (item 0042, [→ 14]).
 2. Connect the drive control according to the circuit diagram in the junction box cover and the manufacturer's operating instructions for the drive control.
 3. Connect the PTC resistor according to the following examples.
 4. Close the junction box cover.

Circuit diagram with PTC resistor and evaluation unit

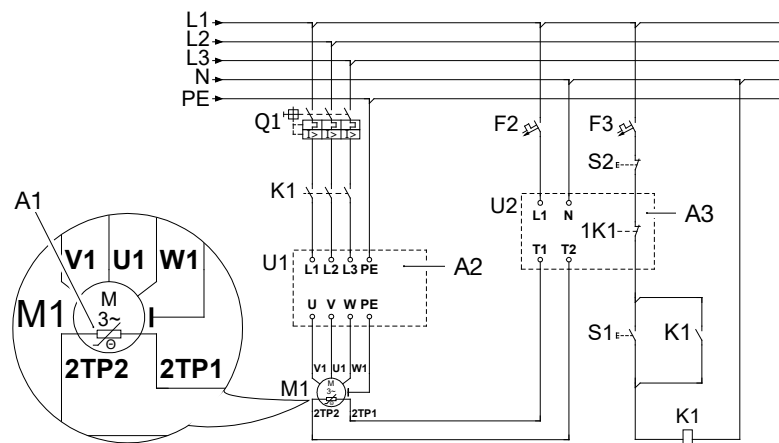

A1 PTC resistor

A2 Drive control

A3 PTC resistor and evaluation unit

Circuit diagram with PTC resistor evaluation via the drive control

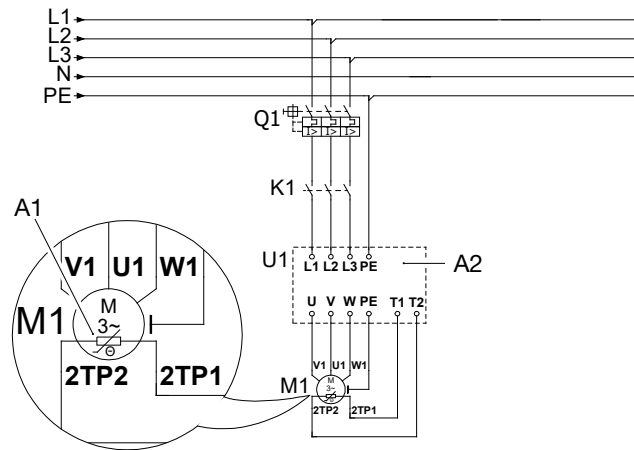

A1 PTC resistor

A2 Drive control

6.5 Connect auxiliary ventilator

This chapter is only valid for G-BH1N | G-BH9N with auxiliary ventilator (item 0501, [→ 15]).

NOTICE

Destruction due to overheating!

For operation without the auxiliary ventilator running, the G-BH1N | G-BH9N can overheat and be destroyed.

① Provide forced switching that prevents an operation of the G-BH1N | G-BH9N without the auxiliary ventilator running.

! The electrical data are provided on the auxiliary ventilator rating plate (item 0501, [→ 15]).

1. Open necessary access points for cable glands.
2. Screw in or insert cable gland and secure with locknut.
NOTICE! The cable glands must not lower the IP protection class.
3. Open the junction box cover.
4. Attach cable lugs to cable to be connected.
5. Attach mains connecting line and connecting rails according to the circuit diagram in the auxiliary ventilator junction box (item 0501, [→ 14]).
 - ✓ M4: **0.8 – 1.2 Nm** (0.60 – 0.90 ft lbs)
 - ✓ M5: **1.8 – 2.5 Nm** (1.35 – 1.85 ft lbs)
6. Close the junction box cover.
✓ M4: **5.5 – 6.0 Nm** (4.10 – 4.40 ft lbs)
7. Connect the auxiliary ventilator to a separate mains connection.

6.6 Connecting accessories

Connect accessories according to the instruction manual supplied with the respective accessory.

6.7 Parameterising the drive control

NOTICE

The G-BH1N | G-BH9N fails due to an overload of the motor!

! G-BH1N | G-BH9N are not ventilators! Operation with the setting "**Variable torque**" or "**Square characteristic**" is not permitted.

① Always operate G-BH1N | G-BH9N with the setting "**Constant torque**" or "**Linear characteristic**".

A clock frequency of 8 kHz is recommended. The minimum clock frequency is 4 Khz .

6.7.1 Parameterise integrated drive control 2FC4

The integrated drive control **2FC4** is already parameterised on delivery. Brake and acceleration times must be adapted to the process. Adjust settings according to the drive control operating instructions [→ 6].

6.7.2 Parameterise wall-mounted drive control 2FC4

1. Parameterise drive control **2FC4** with motor data (rating plate [→ 13]), the drive control parameters [→ 42] and the drive control operating instructions [→ 6].
2. Identify the motor.

6.7.3 Parameterise accompanying drive control from third party

set the optimum process parameters within the limits defined in these instructions using the motor data (rating plate [→ 13]), the drive control parameters [→ 42] and the operating instructions of the drive control manufacturer [→ 6].

7.1 Measures after a long shut-down period

Replace ball bearings and radial shaft seal

- ! When the downtime exceeds **4 years** since the last commissioning.
- 1. Replace the rolling bearing.
- 2. Clean adjacent bearing areas for open ball bearings and re-grease.
- 3. Replace and grease the radial shaft seal.

If the standstill conditions vary (Storage [→ 19]), a reduced ball bearing service life is to be expected.

Measuring the motor insulation resistance

- ① Measure the insulation resistance of the motor at 500V DC voltage between the conductors of the main circuit and protective conductive system.
 - ✓ Value $\geq 1 \text{ M}\Omega$: no measures necessary.
 - ✓ Value $< 1 \text{ M}\Omega$: Dry winding.

7.2 Tests during commissioning or re-commissioning

 **CAUTION**

Overpressure!

Overpressure during the leak test can damage the G-BH1N | G-BH9N.

① To test the plant for leaks, the G-BH1N | G-BH9N must be excluded.

- ① Prior to commissioning or recommissioning of the G-BH1N | G-BH9N, check that:
 - ✓ The G-BH1N | G-BH9N is properly fitted and aligned.
 - ✓ Rotating components move freely.
 - ✓ Pipes and hoses are correctly connected.
 - ✓ Attachments, screw fittings and electrical connections are fixed at the given tightening torques.
 - ✓ The operating conditions match the rating plate details given above.
 - ✓ The maximum speeds are monitored and adhered to through the control.
 - ✓ Protection measures against accidental contact have been completed.
 - ✓ Cooling air supply is not affected.

7.3 Check the direction of rotation

Test the direction of rotation of the compressor

1. Switch on the G-BH1N | G-BH9N briefly and then switch it off again.
2.  **WARNING! When the electrical connection is incorrect: Risk of injury as a result of being pulled or sucked in! Do not perform the overpressure test with your hands!**
 Perform the overpressure test on the gas outlet using a piece of paper (item N2.0, [→ 14]).
 - ✓ Overpressure present: direction of rotation is correct, no measures
 - ✓ Negative pressure present: Direction of rotation incorrect, change direction of rotation by interchanging two phases of electrical supply line

Test the direction of rotation of the auxiliary ventilator

- ! Only required for G-BH1N | G-BH9N with auxiliary ventilator (item. 0501, [→ 15]).
- 1. Switch on the auxiliary ventilator briefly and then switch it off again.
- 2. Hold a sheet of paper in front of the air grille of the auxiliary ventilator (item 0501, [→ 15]).
 - ✓ The sheet is suctioned: direction of rotation is correct, no measures
 - ✓ The sheet is blown off: Direction of rotation incorrect, change direction of rotation by interchanging two phases of electrical supply line

7.4 Sensors function check

- ① Check that sensors (e.g. PTC resistor) are connected correctly.

7.5 Measure the acoustic emissions

- ! It is necessary to measure the acoustic emissions for G-BH1N | G-BH9N without piping, without silencers or without piping.
- 1. Ensure that all persons in the potentially excessive noise area wear ear protection.
- 2. Measure sound during operation.
- 3. If necessary, implement sound protection measures (e.g. Reduction of oscillations and noises [→ 20], provision of ear protection, identification of noise areas).

7.6 Measure oscillations

- ! It is recommended to measure the oscillations for the prescribed operating speeds.
- 1. Measure oscillations.
- 2. If the permitted Speed of oscillation [→ 41] is exceeded, provide measures for Reduction of oscillations and noises [→ 20].

WARNING
Danger of burns from hot surface on the unit and from hot mediums!

! On the surface of the G-BH1N | G-BH9N, temperatures of approx. 160°C/200°C [320°F/392°F] are possible.

1. Do not touch hot surfaces during operation.
2. Allow to cool after removing from service.

When operating the G-BH1N | G-BH9N, comply with the Permitted conditions for use [→ 40].

NOTICE! The gas inlet and gas outlet are swapped in reverse operation. Performance data and cooling, as well as the functions of flow-dependent accessories (e.g. valves, filters), can be limited.

8.1 Switch on

1. If fitted, open the shut-off devices in the suction/pressure lines.
2. Switch the power supply and auxiliary ventilator (if necessary) on.
 - ✓ The G-BH1N | G-BH9N begins to suction conveyed media.

8.2 Switch off

- ! The G-BH1N | G-BH9N can be switched off in each operating condition (i.e. regardless of pressure, temperature, etc.). In doing so, the working process of the system must be observed.
1. Switch the power supply and auxiliary ventilator (if necessary) off.
 - ✓ The G-BH1N | G-BH9N interrupts the suction of the conveyed media. The impeller gradually stops and the pressure is slowly released.
 - ⚠ WARNING! Risk of injury due to rotating impeller: wait until it comes to a stop.**
 2. If fitted, close shut-off devices in suction and pressure lines.

8.3 Switch off in emergency

1. The G-BH1N | G-BH9N can be switched off in emergency without any particular precautions.
 - ✓ If the brakes of the G-BH1N | G-BH9N are actively employed, restarting in the opposite direction of rotation must be prevented.
2. Determine the cause.
3. Rectify the risk.
4. Put the G-BH1N | G-BH9N back into operation [→ 33].

Fault	Cause	Corrective measure	To be carried out by
G-BH1N G-BH9N does not start up and does not make any noise	The power supply of the G-BH1N G-BH9N was interrupted	Correct the break in fuses, terminals or power supply lines	Electrician
	Drive control intermediate circuit voltage is too low	Check mains voltage and drive control	Electrician
	Drive control locked	Use control block	Operating personnel
	Incorrect setpoint source	Change setpoint source	Operating personnel
	Target value of the drive control is "0"	Specify target value	Operating personnel
G-BH1N G-BH9N does not start up and makes noises	Break in one of the power supply lines	Correct the break in fuses, terminals or power supply lines	Electrician
	Impeller grinds or rotor is jammed	Open G-BH1N G-BH9N, remove foreign objects, clean or replace parts	Service*
	Faulty impeller	Replace impeller	Service*
	Rolling bearing is faulty	Replace rolling bearing	Service*
G-BH1N G-BH9N turns unevenly	Defective motor cable	Check motor cable	Electrician
	Underexcitation or overexcitation of the drive control motor	Check the parameterisation	Operating personnel
		Check motor data and if necessary, identify the motor	Operating personnel
After release, the drive control switches into fault	Differential pressure exceeds the limits specified on the rating plate [→ 13]	Reduce differential pressure	Operating personnel
	Impeller grinds or rotor is jammed	Open G-BH1N G-BH9N, remove foreign objects, clean or replace parts	Service*
	Rolling bearing in motor or compressor part faulty	Replace rolling bearing	Service*
	Clogged filters, silencer elements or connecting pipes/hoses	Clean filters, silencer elements and connecting pipes/hoses	Service*
Overcurrent protection triggered again after switching motor on; power consumption too high	Motor overloaded. Settings deviate from details on rating plate	Reduce settings.	Fitter
	Short-circuit in the winding	Check winding	Electrician
	Clogged filters, silencer elements or connecting pipes/hoses	Clean filters, silencer elements and connecting pipes/hoses	Service*
	Impeller grinds or rotor is jammed	Open G-BH1N G-BH9N, remove foreign objects, clean or replace parts	Service*
G-BH1N G-BH9N does not reach the required speed or shows no or too little differential pressure	Incorrect direction of rotation	Check [→ 33] the direction of rotation	Electrician
	Fluctuating density of conveyed media	Take into account recalculation of pressure values; consult the manufacturer	Manufacturer
	Leaks in the unit	Seal the unit	Fitter
	Radial shaft seal is defective	Replace the radial shaft seal	Service*

Fault	Cause	Corrective measure	To be carried out by
	Change in the blade profile due to contamination	Clean the impeller, check for wear and replace if necessary	Service*
	Clogged filters or silencer elements	Clean filters and silencer elements and replace them, if necessary	Fitter
	Incorrect target speed for drive control	Correct the target speed	Fitter
	Analogue input on drive control incorrectly configured	Match the setting to the adjacent analogue signal	Operating personnel
	Maximum output frequency on drive control too low	Increase maximum output frequency Do not exceed the maximum speeds given on the rating plate	Operating personnel
G-BH1N G-BH9N runs, drive control target values are "0"	Minimum output frequency <0 Hz set.	No error, as due to the minimum output frequency default, the G-BH1N G-BH9N always starts up with a frequency <0 Hz, see Rotational speeds [→ 40].	—
Abnormal flow noises	Flow rate too high.	Clean pipe/hoses, use pipes/hoses with a larger cross section if necessary	Fitter
	Silencer inserts dirty or faulty	Clean the silencer inserts, check for wear and replace as necessary	Service*
Abnormal running noises or oscillations	Feet (item 0062, [→ 14]) or foot mount loose or defective	Check tightening torques and tighten screws Replace feet or foot mount	Fitter
	Spring elements (item 5210/5212, [→ 14]) defective	Replace spring elements	Fitter
	Ball bearing degreased or defective	Relubricate or replace the rolling bearing	Service*
	Auxiliary ventilator bearing (item 0501, [→ 14]) defective	Replace auxiliary ventilator	Service*
G-BH1N G-BH9N leaks	Screw connections loose	Check tightening torques and tighten screws	Fitter
Other error messages on drive control	See manufacturer's operating instructions for the drive control	See manufacturer's operating instructions for the drive control	Electrician

* To be corrected by maintenance staff if the maintenance manual is available.

10.1 Maintenance

For the safe operation of the G-BH1N | G-BH9N, the following maintenance intervals are recommended. They are dependent on the operating conditions and must be adjusted by the user as necessary.

Maintenance interval	Maintenance measure	To be carried out by
Depending on the amount of dirt	① Exterior: Check surfaces and attachments for deposits and clean if necessary (e.g. with compressed air).	Operating personnel
	① Interior: Check any areas that convey material for deposits and clean or replace if necessary.	Fitter
Annually	① Check the control for error messages by disconnecting the sensors (e.g. bimetal switch, PTC resistor). Remedy the cause of the error for any malfunctions.	Electrician
20.000 h or 2,5 years	<ol style="list-style-type: none"> 1. Replace the rolling bearing. 2. Replace the radial shaft seal. <p>Maintenance intervals were established based on reference conditions [→ 5] . Different ambient and operating conditions increase (e.g. lack of continuous operation, lower pressure differences) or reduce (e.g. operation with drive control, rapid accelerations, vibrations, extended storage periods) the values. Detailed statements are only possible when taking the actual ambient and operating conditions into consideration.</p>	Service*

* Maintenance and repair by qualified personnel is possible when the repair manual is available.

10.2 Repairs and complaints

Please consult the service department regarding repairs and complaints before sending them to the manufacturer.

- Gardner Denver Deutschland GmbH
 Industriestraße 26
 97616 Bad Neustadt
 Tel.: +49 9771 6888 2000
 Fax: +49 9771 6888 11 2000
 E-mail: er.service-nes@gardnerdenver.com
 Internet: www.gd-elmorietschle.com

10.3 Ordering spare parts

Spare parts order as per repair manual [→ 6].

11.1 Decommissioning



DANGER

**Lethal electric shock from G-BH1N | G-BH9N with drive control!
The drive control continues to be live after the intermediate circuit voltage has been switched off and slowly becomes de-energised.**

1. After switching off, wait for **at least 3 minutes**.
2. Before opening the drive control, ensure that it is de-energised.

! The G-BH1N | G-BH9N can remain in the unit or be dismantled for storage.

1. Disconnect the G-BH1N | G-BH9N from the power supply.
2. Depressurise the pipes.

11.2 Disassembly

1. Disconnect the G-BH1N | G-BH9N from all electrical connections.
2. Dismantle the piping and hoses.
3. Close connections that are open.
4. Loosen the G-BH1N | G-BH9N from the installation surface.
5. Store [→ 19] or dispose of [→ 39] G-BH1N | G-BH9N.

11.3 Disposal

WARNING

**Burns, chemical burns or poisoning!
Risk of injury due to contact with residual hazardous substances in the G-BH1N | G-BH9N.**

① Decontaminate the G-BH1N | G-BH9N as instructed by the manufacturer of the hazardous substances.

1. Remove the G-BH1N | G-BH9N according to the repair manual [→ 6].
2. Collect solvents, residual lacquer and grease and dispose of them in accordance with the valid local regulations.
3. Dispose of components according to the valid local regulations or recycle them.



12.1 Permitted conditions for use

Any deviations from the following **permissible operating conditions** must be agreed with the manufacturer.

12.1.1 Installation height

The maximum installation height is **1000 m above sea level** (3280 ft above sea level) provided no other installation height is specified on the rating plate under item M, [→ 13].

12.1.2 Rotational speeds

Mechanical speeds for operation without drive control

For speed, see rating plate (item K), [→ 13].

Mechanical speeds for operation with drive control

Minimum		Maximum	
[min ⁻¹]	[Hz]	[min ⁻¹]	[Hz]
600	10	5000	84

12.1.3 Temperatures

For deviating temperatures, see the rating plate item M, [→ 13].

Temperature of the conveyed media

Typ	Minimum		Maximum	
	[°C]	[°F]	[°C]	[°F]
2B2BH1 2BH9	-20	-4	+40	+104
2BH1...-2 2BH1800-0AK16-ZN00 2BH1800-0AK26-ZN00	-20	-4	+200	+392

Ambient temperature

Minimum		Maximum	
[°C]	[°F]	[°C]	[°F]
-20	-4	+40	+104

12.1.4 Pressure differences

Pressure differences that can be generated in operation by G-BH1N | G-BH9N

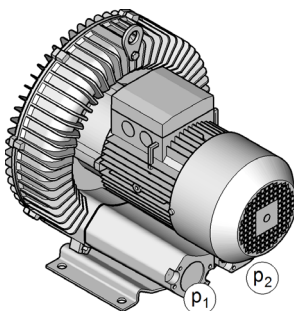

Maximum compressor operation [mbar]	Maximum vacuum operation [mbar]
Item p ₂ , [→ 13]	Item p ₁ , [→ 13]

The pressure differences specified on the rating plate serve as reference conditions [→ 5] and have a tolerance of ±10%.

Loss of piping must be considered.

Mechanical damage or premature failure of G-BH1N | G-BH9N due to inadmissible pressure loads!

- ① A long-term, **constant pressure load** at standstill can degrease the rolling bearing.

12.1.5 Relative humidity

Ambient relative humidity

Maximum **60%** at **+40°C** (+104°F)

Relative humidity of conveyed media

Condensate formation is not permitted in the internal space of the G-BH1N | G-BH9N.

12.1.6 Minimum distances for heat dissipation

Adhere to the following minimum distances for heat dissipation:

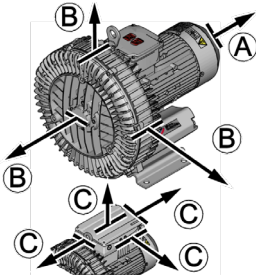

Type	A		B		C	
	[mm]	[in]	[mm]	[in]	[mm]	[in]
2BH14	35	1.38	20	0.79	200	7.88
2BH15	55	2.17	20	0.79	200	7.88
2BH16	55	2.17	30	1.18	200	7.88
2BH18 – 2BH19	55	2.17	40	1.57	200	7.88
2BH92300	55	2.17	55	2.17	200	7.88

12.1.7 Speed of oscillation

Maximum permissible oscillation speed for the assembled G-BH1N | G-BH9N:

Maximum permissible oscillation speed for the constructed machine

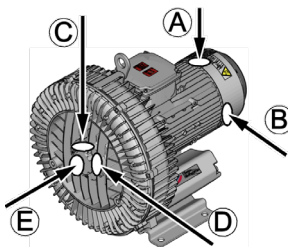

Installation	[mm/s]	[in/s]
Rigid (e.g. foundation)	2,8	0.110
Flexible (e.g. spring elements)	4,5	0.177

The oscillation speed must be determined at the following measuring points

- on the motor side
 - vertically (fan guard/auxiliary ventilator screw connection - A)
 - horizontally (fan guard/auxiliary ventilator screw connection - B)
- on the compressor part
 - vertically (compressor cover - C)
 - horizontally (compressor cover - D)
 - axially (compressor cover - E)

12.1.8 Accelerations

Maximum permissible acceleration for the constructed machine

0.3 x g

NOTICE! The rolling bearings can be destroyed by excessive alternating stresses.

12.2 Electrical data

Any deviations from the following **electrical data** must be agreed with the manufacturer.

The electrical data are provided on the rating plate [→ 13].

12.2.1 Increased operating cycle frequency

The G-BH1N | G-BH9N is designed for heavy-duty operation. Consultation with the manufacturer is necessary for increased operating cycle frequency.

12.2.2 Drive control parameters

Data for parameterising the drive control are provided on the Rating plates [→ 13] and in the manufacturer's instructions for the drive control.

12.3 Weight

The maximum possible weight of the largest individual motor and drive control are specified. See dimensional drawing for type-specific weights.

Type	Without drive control		With built-in drive control	
	[kg]	[lbs]	[kg]	[lbs]
2BH140 2BH143 2BH149	22	49	27	60
2BH141	36	80	41	91
2BH150 2BH153 2BH159	34	75	39	86
2BH151	68	150	77	170
2BH160 2BH163 2BH169	55	122	64	141
2BH161 2BH164	87	192	108	238
2BH180 2BH183	143	316	164	362
2BH181 2BH184	208	459	229	505
2BH190 2BH193	255	563	276	609
2BH191	335	739	356	785
2BH1940	335	739	356	785
2BH1943	363	800	384	847
2BH92300	165	364	186	410

12.4 Acoustic emissions

Emission sound pressure level L_{pA} according to noise test code ISO 2151 with reference to the basic standard ISO 3744. Measured at a distance of **1 m** [3.28 ft] for 70% Δp_{max} and connected supply lines, tolerance ± 3 dB(A).

Type	50 Hz	60 Hz
	[dB(A)]	[dB(A)]
2BH140 2BH149	63	64
2BH141	66	69
2BH143	63	64
2BH150 2BH159	64	70
2BH151	72	74
2BH153	64	70
2BH160 2BH169	69	72
2BH161	73	76
2BH163	69	72
2BH164 2BH166	74	78
2BH180	70	74
2BH181	74	78
2BH183	70	74
2BH184	74	78
2BH190	74	79
2BH191	74	84
2BH193	75	80
2BH1940	75	84
2BH1943	75	84
2BH92300	79	81



www.gd-elmorietschle.de
er.de@gardnerdenver.com

**Gardner Denver
Deutschland GmbH**
Industriestraße 26
97616 Bad Neustadt · Deutschland
Tel. +49 9771 6888-0
Fax +49 9771 6888-4000

Elmo Rietschle is a brand of Gardner Denver

**Gardner
Denver**

Your Ultimate Source for Vacuum and Pressure