

Operating Instructions G-BH1N ATEX 3G and 3D

2BH1 . . . - 1 . D | 2BH1 . . . - 1 . G

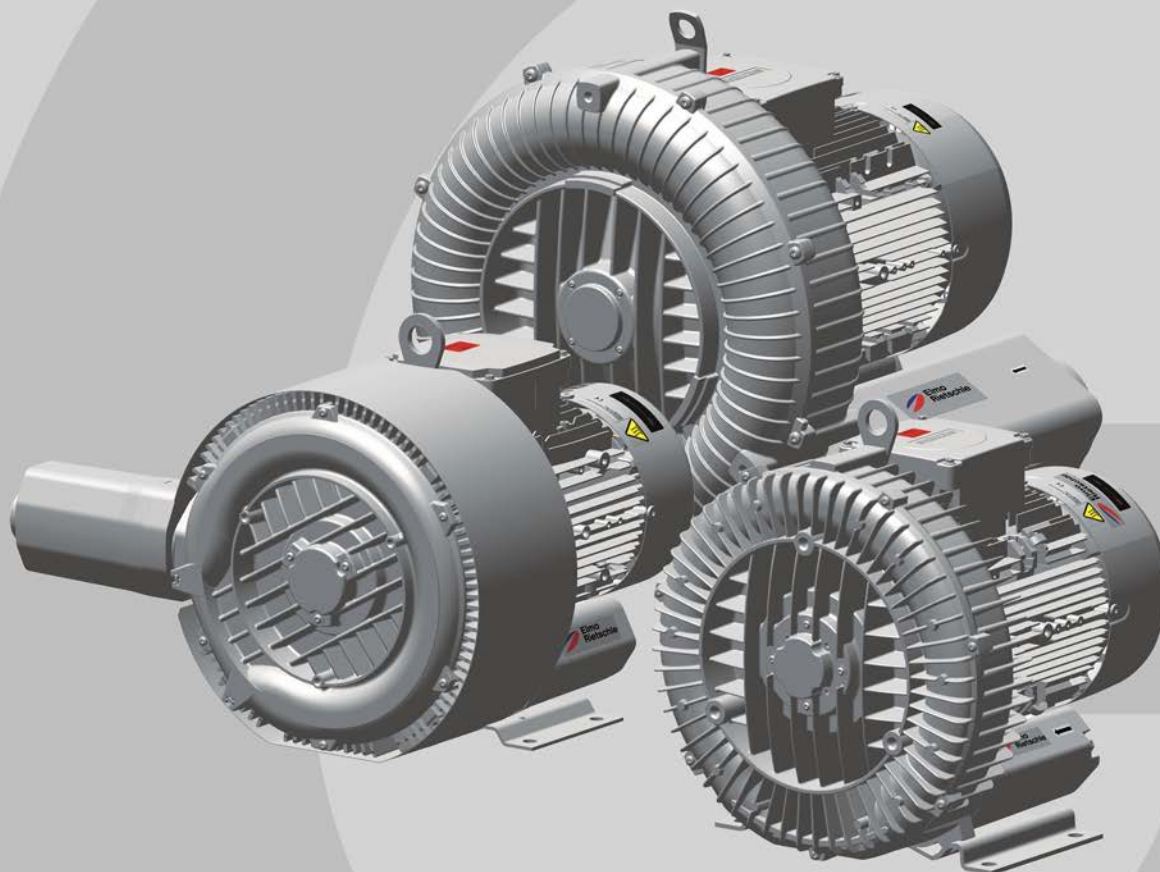

G-Serie
G-Series
Seitenkanal
Side Channel



1	About this manual	4
1.1	Content of this document	4
1.2	Target group	4
1.3	Explanation of the terms and symbols	4
1.4	Changes in comparison to the previous version	7
1.5	Other valid documents	7
2	Safety and responsibility	8
2.1	Explanation of warning signs	8
2.2	Correct use of the equipment	8
2.3	Unauthorised operation	9
2.4	Working in a safety-conscious manner	10
2.5	Requirements for personnel	11
2.5.1	Personnel qualifications and training	11
2.5.2	Personal protective equipment	13
2.6	Requirements of the operator	13
3	Product identification	15
3.1	Structure of the type description	15
3.2	Rating plate	16
3.3	Design of the machine	17
3.4	Versions and options	17
3.5	Ancillaries	18
3.6	Function principle	18
3.7	EC/EU declaration of conformity	19
4	Transportation and storage	21
4.1	Unpacking and checking the condition of delivery	21
4.2	Lifting and transporting	21
4.3	Storage	22
5	Installation	23
5.1	Measures after long-term storage	23
5.2	Mounting conditions	23
5.3	Reduction of oscillations and noises	24
5.4	Mounting	25
5.4.1	Level assembly on the foot	25
5.4.2	Vertical mounting on the compressor cover	25
5.5	Fit loose silencer	26
5.6	Mount the accessories	27
5.7	Connecting pipelines and hoses	27
6	Electric power connection	30
6.1	General installation regulations	30
6.2	Additional installation requirements for frequency inverters	31
6.3	Controls	32
6.4	Connect the motor to the mains	33
6.5	Connecting the frequency inverter to the mains	36
6.6	Connecting accessories	37
7	Commissioning	38
7.1	Measures after a long shut-down period	38
7.2	Tests during commissioning or re-commissioning	38
7.3	Check gap and direction of rotation	39
7.4	Checking the sensors	39
7.5	Measure the acoustic emissions	39
7.6	Measure oscillations	39

8	Operation	40
8.1	Switch on	40
8.2	Switch off	40
8.3	Switch off in emergency	40
8.4	First inspection after installation or repair	41
9	Troubleshooting	42
10	Maintenance	44
10.1	Maintenance	44
10.2	Repairs and complaints	45
10.3	Ordering spare parts	45
11	Decommissioning	46
11.1	Decommissioning	46
11.2	Disassembly	46
11.3	Disposal	46
12	Technical data	47
12.1	Permitted conditions for use	47
12.1.1	Installation height	47
12.1.2	Rotational speeds	47
12.1.3	Temperatures	47
12.1.4	Pressure differences	48
12.1.5	Relative humidity	48
12.1.6	Minimum distances for heat dissipation	48
12.1.7	Speed of oscillation	48
12.1.8	Accelerations	48
12.2	Electrical data	49
12.2.1	Increased operating cycle frequency	49
12.3	Weight	49
12.4	Acoustic emissions	50

1.1 Content of this document

These operating instructions:

- is part of the side-channel compressor:

Series	G-BH1N ATEX
Types	2BH1...-1.D 2BH1...-1.G
- describe the safe, proper and efficient use in all phases of its service life.
- must always be available to personnel at the place of use.
- Arranged in the main sections:
 - About these instructions
 - Safety and responsibility
 - Product identification
 - Transportation and storage
 - Mounting
 - Electric power connection
 - Commissioning
 - Operation
 - Troubleshooting
 - Maintenance, repairs and spare parts
 - Decommissioning
 - Technical data







The main section on “Safety and responsibility” must always be observed. The subsequent main sections can be used as a reference and can be read independently from each other. Cross references provided must be observed.







1.2 Target group

These instructions are intended for operating personnel, qualified personnel, electricians, operators and planners. See also Personnel qualifications and training [→ 11].

1.3 Explanation of the terms and symbols

In these instructions symbols and terms will be used to mean the following.

Symbol	Explanation
!	Requirement, pre-requisite
1. 2. 3.	Handling instructions
✓	Result
[→ 17]	Cross reference with page reference
	Additional information, tips
	Direction of rotation arrow
	Direction of conveyance arrow
	Collect electrical or electronic equipment separately, do not dispose of it via the residual waste bin
	General warning sign (warning of risk of injury)
	Potentially explosive atmosphere warning

Symbol	Explanation
	Explosive material warning
	G-BH1N ATEX can start without warning
	Electrical voltage warning
	Hot surface warning
	Disconnect prior to maintenance or repair
	Earth prior to use
	Observe the instructions

Term	Explanation
Plant	Part provided by the user in which the G-BH1N ATEX is installed
G-BH1N ATEX = Side-channel compressor	Vacuum pump/compressor for generating vacuum and/or overpressure. The G-BH1N ATEX consists of the compressor part and drive, as well as other accessories if required.
Drive	Asynchronous motor and possibly frequency inverter
Side-channel	Compression principle
Compressor	Mechanical part of the G-BH1N ATEX without a drive
Inner chamber of the compressor	Chamber of the compressor part with which the media to be conveyed comes into contact
Impeller	Rotating component for generating pressure within the inner chamber of the compressor
Gas inlet	Position for gas inlet
Gas outlet	Position for gas outlet
Single-stage	Compressor part with a compressor stage
Two-stage	Compressor part with two compressor stages operated in series. Generates higher pressure difference.
Twin-flow	Compressor part with two compressor stages operated in parallel. Generates higher volume flow.
Substructure	Mounting plate, base frame or foundation on which the G-BH1N ATEX is constructed
Elastic / rigid	When the lowest normal frequency of the system, consisting of the variable and substructure, is less than 25 % above the rotary frequency of the G-BH1N ATEX per measurement direction, then the substructure is considered to be rigid. All other substructures are considered to be elastic.
Assembly environment	Space in which the G-BH1N ATEX is set up and operated (this may differ from the suction environment)
Suction/discharge environment	Chamber from which the media to be conveyed is suctioned or in which the media to be conveyed is expelled (this may differ from the assembly environment)

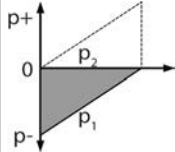
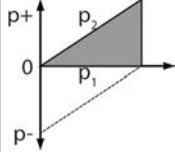
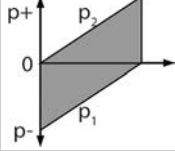
Term	Explanation	
Reference conditions	<ul style="list-style-type: none"> Ambient temperature and suction temperature: +15 °C (+59 °F) Ambient pressure: 1013 mbar abs. (14.7 psi abs.) Conveyed media: air Speed: 3600 min⁻¹ (60 Hz) in continuous operation Maximum pressure difference according to rating plate Horizontal assembly 	
Volume flow	Volume of air or gas that is conveyed per unit of time	
Vacuum operation	Operation with <ul style="list-style-type: none"> pressure at gas inlet $p_1 < p_{\text{atm}}$ and pressure at gas outlet $p_2 = p_{\text{atm}}$. 	
Compressor operation	Operation with <ul style="list-style-type: none"> pressure at gas inlet $p_1 = p_{\text{atm}}$ and pressure at gas outlet $p_2 > p_{\text{atm}}$. 	
Mixed operation	Operation with <ul style="list-style-type: none"> pressure at gas inlet $p_1 < p_{\text{atm}}$ and pressure at gas outlet $p_2 > p_{\text{atm}}$. 	
Reverse operation	Operation with change in direction of rotation without intermediate standstill	
Mobile operation	Non-stationary operation	
Anti-clockwise operation (standard)	The direction of rotation is anti-clockwise when facing the compressor cover	
Reverse operation	Operating while the machine runs in the opposite direction of rotation	
External frequency inverter (ATEX)	Frequency inverter made to the specifications of the ATEX motor manufacturer	
Notified body (ATEX)	Conformity assessment body that has been officially appointed by the national authority to carry out the conformity assessment procedure within the meaning of Directive 2014/34/EU	
Zone (ATEX)	Classification by the operator into potentially explosive atmospheres according to the frequency and duration of the occurrence of a potentially explosive atmosphere	
Category (ATEX)	Classification and labelling by the manufacturer of the G-BH1N ATEX that specifies in which zones the operator may use the G-BH1N ATEX. The device group II category differentiates according to substance group (gas dust) and frequency and duration of the occurrence of a potentially explosive atmosphere (constantly, frequently or for a longer period occasionally rarely and briefly)	
Explosion group (ATEX)	They are divided into the groups of gases, mists, vapours (II) and dusts (III). Group II (gas) is divided into three subgroups according to the explosiveness of the gas atmosphere: IIA, IIB and IIC Group III (dusts) is divided into three subgroups according to the explosiveness of the dust atmosphere: IIIA, IIIB and IIIC	

1.4 Changes in comparison to the previous version

Changes compared with version 04.2021

- Other valid documents [→ 7]
- Requirements of the operator [→ 13]
- EC/EU declaration of conformity [→ 19]
- Additional installation requirements for frequency inverters [→ 31]
- Connect the motor to the mains [→ 33]
- Connecting the frequency inverter to the mains [→ 36]
- Operation [→ 40]
- Troubleshooting [→ 42]
- Maintenance [→ 44]

1.5 Other valid documents



In addition to these instructions consider the following documents:

Document	Purpose
Data sheet	Characteristic curve and electrical data for the G-BH1N ATEX
Dimensional drawing	Technical data for the G-BH1N ATEX (e.g. box dimensions, connection dimensions, mass)
Operating instructions SINAMICS G120 frequency inverter	Only for G-BH1N ATEX with option M75: Information regarding the safe and proper handling of the frequency inverter in all phases of its life.
Certificate of compliance for frequency inverter SINAMICS G120	Only for G-BH1N ATEX with option M75: List of permitted frequency inverters with technical data
Assembly instructions *	Description of the assembly of the manufacturer's accessories
Supplier documentation *	Operating manual and further documentation of the supplier's components

*according to the model option or accessories

The manufacturer is not liable for damage caused by the failure to observe these instructions and the related documents [→ 7].

2.1 Explanation of warning signs

Warning sign	Explanation
 DANGER	Danger that failure to observe the measures could lead to death or serious physical injuries.
 WARNING	Danger that failure to observe the measures could lead to death or serious physical injuries.
 CAUTION	Danger that failure to observe the measures could lead to minor physical injuries.
NOTICE	Danger that failure to observe the measures could lead to material damage.

2.2 Correct use of the equipment

The G-BH1N ATEX:

- is a machine that is optimised for continuous operation used to generate a vacuum or pressure.
- can be used inside buildings, outside and in dusty or damp environments. The protection class is indicated on the rating plate [→ 16].
- is suited for operation in **Zone 2** or in **Zone 22**, in which a potentially explosive atmosphere from explosion group IIB or from explosion group IIIB, respectively, **normally does not occur or does so only rarely and for a short period of time**.
- fulfils the ATEX temperature classes **T3 for gases** and the maximum permissible surface temperature of **+125°C for dusts**.
- can deliver the following conveyed media:
 - gases with a relative humidity of up to 80% and dusts for which a potentially explosive atmosphere from explosion group IIB (**Zone 2**) or a potentially explosive atmosphere from explosion group IIIB (**Zone 22**) **does not occur during normal operation or does so only rarely and for a short period of time**.
- should only be used within the limits defined in this documentation:
 - Mounting conditions [→ 23].
 - Permitted conditions for use [→ 47].
 - Electrical data [→ 49].
- only operate when fully assembled and in a technically perfect condition.

Danger of explosion due to hybrid mixtures



WARNING

Danger of explosion due to hybrid mixtures!

Conveying hybrid mixtures can lead to explosions that cause fatal injuries.

- ① Conveying hybrid mixtures is prohibited without an additional assessment of the individual case by a notified body.

Hybrid mixtures are mixtures of combustible dusts with explosive gas/air mixtures, which, if they occur at the same time, can form a dangerous potentially explosive atmosphere.

Changes to the safety-related parameters can thereby occur, such as a change to the zoning, an increase in explosion pressure, a reduction of the minimum ignition energy and a reduction of the maximum temperatures to be observed. This can lead to an explosion. Death, serious injury or material damage can be the result of this.

If hybrid mixtures occur, the relevant parameters for gas (Zone 2) and explosion group IIB, as well as for dust (Zone 22) and explosion group IIIB must be considered. A notified body must assess whether, in the case of a hybrid mixture, the key parameters for ignition are adversely affected.

Motors with double labelling for G (“Gas”) and D (“Dust”) can only be used after the properties of the hybrid mixtures have been tested by a notified body if they occur at the same time.

Danger of explosion due to hybrid environment

Use of the G-BH1N ATEX in an explosive gas and dust atmosphere occurring at the same time is prohibited.

Ignition protection type Ex ec

The electrical component (drive) is designed with ignition protection type Ex ec for “increased safety” according to IEC 60079-0 and IEC 60079-7. Only operate the machine with ignition protection type Ex ec in potentially explosive areas designated under **Zone 2** according to IEC 60079-10-1 and according to the stipulations of the responsible supervisory authority. The operator is responsible for determining the risk of explosion (zone classification).

Ignition protection type Ex tc

The electrical component (drive) is designed with the Ex t “Protection by housing” ignition protection type according to IEC 60079-0 and IEC 60079-31. Only operate the machine with ignition protection type Ex tc in potentially explosive areas designated under **Zone 22** according to IEC 60079-10-2. The dust layer on the housing of G-BH1N ATEX must not exceed 5 mm for protection type Ex t.

Ignition protection type Ex h

The non-electrical part (compressor parts) has the “constructional safety” or “control of ignition sources” ignition protection type according to IEC 80079-36 and IEC 80079-37.

Other operating conditions must be agreed with the manufacturer.

2.3 Unauthorised operation



⚠ WARNING

Danger of explosions!

The use of conveyed media that are not permitted can lead to explosions that cause fatal injuries.

- ① Gases, gas mixtures and dusts which are explosive when air is not present, or which may change the safety-relevant material properties of the G-BH1N ATEX, must not be conveyed.

It is forbidden to:

- use in areas where explosive gases and dusts occur constantly, for extended periods, frequently, or occasionally.
- in biogas applications: aspirating from or discharging into explosive areas.
- conveying gases and dusts that are constantly, for extended periods, frequently, or occasionally explosive.
- conveying flammable, aggressive, unstable or oxydative materials.
- operation in salty or aggressive atmospheres.
- conveying any form of metal oxides (e.g., iron oxide) (exception: G-BH1N ATEX with Option HC1).
- operation against closed pressure and suction side.
- using non-commercial facilities without making adjustments for the additional requirements.

- operating in reverse with sudden/abrupt changes in the direction of rotation. **NOTICE! This results in high drive loads and alternating stresses. The machine can be destroyed.**
- reverse operation.
- use in areas with ionising or non-ionising radiation.
- operating outside of the limits defined in this document:
 - Mounting conditions [→ 23].
 - Permitted conditions for use [→ 47].
 - Electrical data [→ 49].

2.4 Working in a safety-conscious manner

Work at a standstill and de-energised **Work on running or energised G-BH1N ATEX can lead to serious injuries due to body parts being drawn in or crushed or death due to electric shock.**



1. Work on the G-BH1N ATEX at a standstill only and in a de-energized condition.

Negative/overpressure and ejected conveyed media **Pressures and ejected conveyed media can cause serious injuries.**

1. Depressurise the system before starting work on the G-BH1N ATEX.
2. Check that all components are depressurised.
3. Check that no conveyed media can escape.

Screw connections **Screws can damage the thread when screwed in repeatedly. This can cause screwed parts to become loose and lead to severe injuries.**

1. Replace damaged screws.
2. Insert screws into the open thread by hand.
3. Afterwards, use a screwdriver to tighten the screws.

Hot surfaces **During operation and after decommissioning, contact with hot surfaces can lead to burns.**



1. Do not touch hot surfaces during operation.
2. Keep hot surfaces clear of highly inflammable materials.
3. Allow the G-BH1N ATEX to cool after shutting it down.

Not fully assembled or damaged **Operation with exposed or damaged parts can lead to serious injuries due to body parts being drawn in and severed or crushed.**

1. Replace damaged parts prior to beginning operation.
2. Re-attach safety and protective devices and put them back into operation immediately after completion of work.
3. The G-BH1N ATEX should only be put into operation when fully assembled.
4. After disassembly or assembly, conduct the prescribed ATEX tests and ATEX inspections.

Changes, additions and conversions **Changes, additions and conversions may lead to unforeseeable risks and thus to serious injuries or death.**

Modifications, additions and conversions not described in the general documentation are the sole responsibility of the operator.

Only use original parts or parts and auxiliary materials (grease, sealant) recommended by the manufacturer.

Keep all notices attached to the G-BH1N ATEX in a clearly legible condition:

- Labelling of connections
- rotation arrows
- Rating plate
- Warning signs

Malfunctions during operation

The following changes compared to normal operation affect the function and can lead to malfunctions and injuries.

- Higher power consumption, temperatures or vibrations.
 - Unusual noises or smells.
 - Activation of monitoring systems.
1. Notify service personnel immediately.
 2. If in doubt, switch the G-BH1N ATEX off immediately, observing the system-specific safety conditions.

2.5 Requirements for personnel

2.5.1 Personnel qualifications and training



WARNING

Danger of explosions!

Repair work by untrained and non-certified maintenance staff can lead to explosions.

- ① Only maintenance staff that are trained and certified by the manufacturer in accordance with Directive 2014/34/EU and for the G-BH1N ATEX can carry out maintenance and repair work or rectify faults whereby the G-BH1N ATEX must be opened.



All those who will work on the G-BH1N ATEX must have read and understood these instructions and the related documents [→ 7].

Personnel in training may only work on the G-BH1N ATEX under supervision of personnel who have the **required knowledge**.

Only personnel with the following knowledge may carry out the work described in these instructions:

Work task	Personnel	Required knowledge
Transportation, storage	Shipper, dealer, fitter	<ul style="list-style-type: none"> ▪ Safe handling with lifting gear such as hoists and fork lift trucks
Assembly, start-up, correcting faults (without opening the G-BH1N ATEX), shut down, dismantling	Fitter	<ul style="list-style-type: none"> ▪ Safe handling of tools ▪ Laying and connecting pipes and hoses ▪ Mounting mechanical components ▪ Knowledge of vacuum pumps and compressors ▪ Qualification to work on explosion-protected devices and in potentially explosive areas
Working on the electrical system	Electrician	<ul style="list-style-type: none"> ▪ Training in the installation, checking, maintenance and repair of electrical installations ▪ Reading, evaluation and safe implementation of instructions, circuit diagrams and technical specifications ▪ Assessing the effectiveness of electrical protection measures ▪ Qualification to work on explosion-protected devices and in potentially explosive areas
Parameterise the frequency inverter	Operating personnel, electricians	<ul style="list-style-type: none"> ▪ Knowledge of frequency inverters and how to set them ▪ Qualification to work on explosion-protected devices and in potentially explosive areas

2 Safety and responsibility



Work task	Personnel	Required knowledge
Operation	Operating personnel	<ul style="list-style-type: none"> ▪ Instructions for occupational safety, working in potentially explosive areas and handling vacuum pumps and compressors
Maintenance repair correcting faults (without opening the G-BH1N ATEX)	Maintenance staff	<ul style="list-style-type: none"> ▪ that are trained and certified by the manufacturer in accordance with Directive 2014/34/EU and for the G-BH1N ATEX ▪ if necessary, a country-specific permit to work on explosion-protected devices and in potentially explosive areas ▪ Safe handling of tools and materials ▪ Disassemble and mount vacuum pumps and compressors ▪ Assess damage to vacuum pumps and compressors
Disposal	Disposal specialist, fitter	<ul style="list-style-type: none"> ▪ Decontaminating polluted materials ▪ Re-use of materials and substances ▪ Correct and environmentally-friendly disposal of materials and substances

2.5.2 Personal protective equipment

 **WARNING**

Danger of crushing and cutting!

Crushing and cutting of body parts due to sharp edges or falling parts on the open G-BH1N ATEX.

1. Wear protective gloves, safety footwear and safety goggles for all assembly and disassembly, troubleshooting and maintenance work.
2. In addition, wear head protection for transportation and overhead work.

 **WARNING**

Risk of injury!

Serious injuries due to body parts and hair being sucked or drawn in (vacuum) or due to projected particles (pressure).

1. Wear eye protection and tight clothes for all work when in operation.
2. Wear a hair net for long hair.
3. Remove jewellery and rings.

 **WARNING**

Hearing damage!

Hearing damage due to time spent in noisy area under adverse operating conditions or due to noise caused by conveyed media being discharged from the gas outlet or piping.

- ① Wear ear protection when remaining in the excessive noise area.

2.6 Requirements of the operator

 **WARNING**

Destruction due to bursting or exploding!

Any machine that is operated at a pressure or speed that is beyond that which is permitted can explode or burst and cause serious injuries due to parts flying off and conveyed media being suddenly ejected.

1. The operator must ensure that the pressures [→ 48] that affect the G-BH1N ATEX are not exceeded.
2. The operator must ensure that the revolutions [→ 47] are not exceeded.

 **WARNING**

Danger of explosions!

As the G-BH1N ATEX is not gas-tight, an explosive mixture can form from the conveyed media and the environment and lead to explosions that cause fatal injuries.

! When using conveyed media that can form explosive mixtures when they come into contact with the environment:

1. Install forced ventilation.

OR

2. Install gas monitoring with forced switch-off. The operator must define the disconnection conditions depending on the conveyed media and the environment.

WARNING

Risk of injury!

As the G-BH1N ATEX is not gas-tight, conveying media other than air can lead to severe or fatal injuries (e.g. asphyxiation, burns).

- ① Adhere to the safety measures described for the material being conveyed (e.g. check leakage rates and provide for gas monitoring or forced ventilation).



NOTICE

For basic requirements for the operation of electrical systems in potentially explosive atmospheres, see Directive 1999/92/EC and IEC 60079-14.

The operator ensures that:

- Assignment, responsibility and supervision of personnel is regulated.
- Personnel have the necessary Personnel qualifications and training [→ 11].
- Personnel have been sufficiently informed of these instructions and all related documents [→ 7].
- The content of these instructions and locally applicable documents are always available to personnel.
- only conveyed media that are approved for the corresponding category and explosion group are used.
- Personnel are informed of dangers related to conveyed material and the necessary safety precautions.
- all local and plant-specific safety measures are complied with:
- the free drawing in or emission of the conveyed media does not place any personnel in danger.
- dangers due to electrical energy are not possible.

Electromagnetic fields when operating with a frequency inverter

G-BH1N ATEX generates electromagnetic fields during operation. Staying in the immediate vicinity of the machine can cause life-threatening malfunctions in medical implants, e.g. pacemakers. Data may be lost in magnetic or electronic storage devices.

- Ensure that any personnel working on the G-BH1N ATEX are protected by using appropriate measures, e.g. labels, safety briefings.
- Prohibit people with pacemakers from approaching the G-BH1N ATEX.
- Observe any national protection and safety regulations.
- Keep magnetic or electronic storage devices away from the G-BH1N ATEX.

3.1 Structure of the type description

2BH1N

2BH1 4 0 0 - 1 AD 1 6 -ZNxx

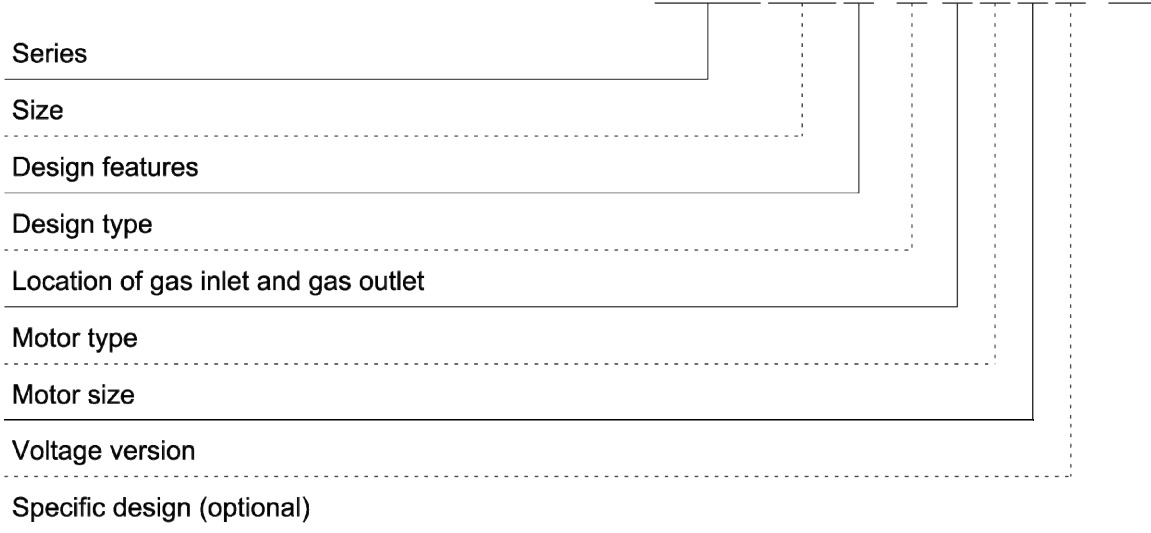

3.2 Rating plate

Rating plate for compressor (item 2000, [→ 17])

Gardner Denver		A G-BH. 2BH.....	Q
compressor / vacuum pump		B BN XXXXXXXX XXX / YYYY-MM IP xx	
Made in Germany Industriestraße 26 97616 Bad Neustadt		C xx.x xxx xxx xxx xxx	
E CE	E II x/xG Ex xx/x xxx xx xx	operating w/o converter	xx Hz - xxx xxx mbar
F xxxxxxxxxxxxxxxxxxxxxxxxxxxxxxxx	E II x/xD Ex xx/x xxxx xxxxx xx	D Hz - p ₂ p ₁ mbar	
F xxxxxxxxxxxxxxxxxxxxxxxxxxxxxxxx	F xxxxxxxxxxxxxxxxxxxxxxxxxxxxxxxx	operating with converter	xx Hz - xxx xxx mbar
F xxxxxxxxxxxxxxxxxxxxxxxxxxxxxxxx	G		xx Hz - xxx xxx mbar
F xxxxxxxxxxxxxxxxxxxxxxxxxxxxxxxx			xx Hz - xxx xxx mbar

- A Series, Type
- B Serial number, date of manufacture, Protection class
- C Options
- D Frequency
- E ATEX marking
- F Manufacturer's recommendations (optional)
- G Customer information (optional)
- p Pressure differences
 - p₁ Values with a negative sign apply to vacuuming and vacuum operations
 - p₂ Values with a positive sign apply to pressure and compressor operations
- Q Serial number, date of manufacture as data matrix code

Rating plate for ATEX motor (item 2001, [→ 17])

H 3 - Motor	GDAxxxx-xxxxx	IEC/EN 60079 T	J L. x	Q	NES1AV3131A	
No. BN xxxxxxxx xxx/xxxx-	K IP xx				VIK CC 032A	
Hz	kW	r.p.m.	V	A	P.F	nom. eff.
xx	xxx	xxxx	xxx / xxx Δ / Y	xxx / xxx	xxx	IEEx xxx%
xx	xxx	xxxx	xxx / xxx Δ / Y	xxx / xxx	xxx	IEEx xxx%
L	M	N	O	R	S	T
U IA / IN: xxx	xx / xx / xx	V xxs/xxs/xxs				Made in Germany

Rating plate for ATEX motor with frequency inverter (item 2001, [→ 17])

H 3 - Motor	GDAxxxx-xxxxx	IEC/EN 60079 T	J L. x	Q	NES1AV3131A		
No. BN xxxxxxxx xxx/xxxx-	K IP xx				VIK CC 032A		
Hz	kW	r.p.m.	V	A	P.F	nom. eff.	operation
xx	xxx	xxxx	xxx / xxx Δ / Y	xxx / xxx	xxx	IEEx xxx%	at line voltage
L	M	N	O	R	S	T	
U IA / IN: xxx	xx / xx / xx	V xxs/xxs/xxs					with converter Fa. Siemens
xx	xxx	xxxx	xxx / xxx Δ / Y	xxx / xxx	xxx	IEEx xxx%	Typ: xxxxxxxxxxxxxxxx
xx	xxx	xxxx	xxx / xxx Δ / Y	xxx / xxx	xxx	IEEx xxx%	UE= xxx V W
xx	xxx	xxxx	xxx / xxx Δ / Y	xxx / xxx	xxx	IEEx xxx%	fp> x kHz X Made in Germany

- H Motor type
- J Motor standards
- K Serial number for motor
- L Motor frequency
- M Motor output power
- N Motor rated speed
- O Motor with switching mode rated voltage
- R Motor rated current
- S Motor power factor
- T Nominal efficiency
- U Starting current to rated current
- V Temperature classes with disconnection times
- W Input voltage for frequency inverter
- X Pulse frequency for frequency inverter

3.3 Design of the machine

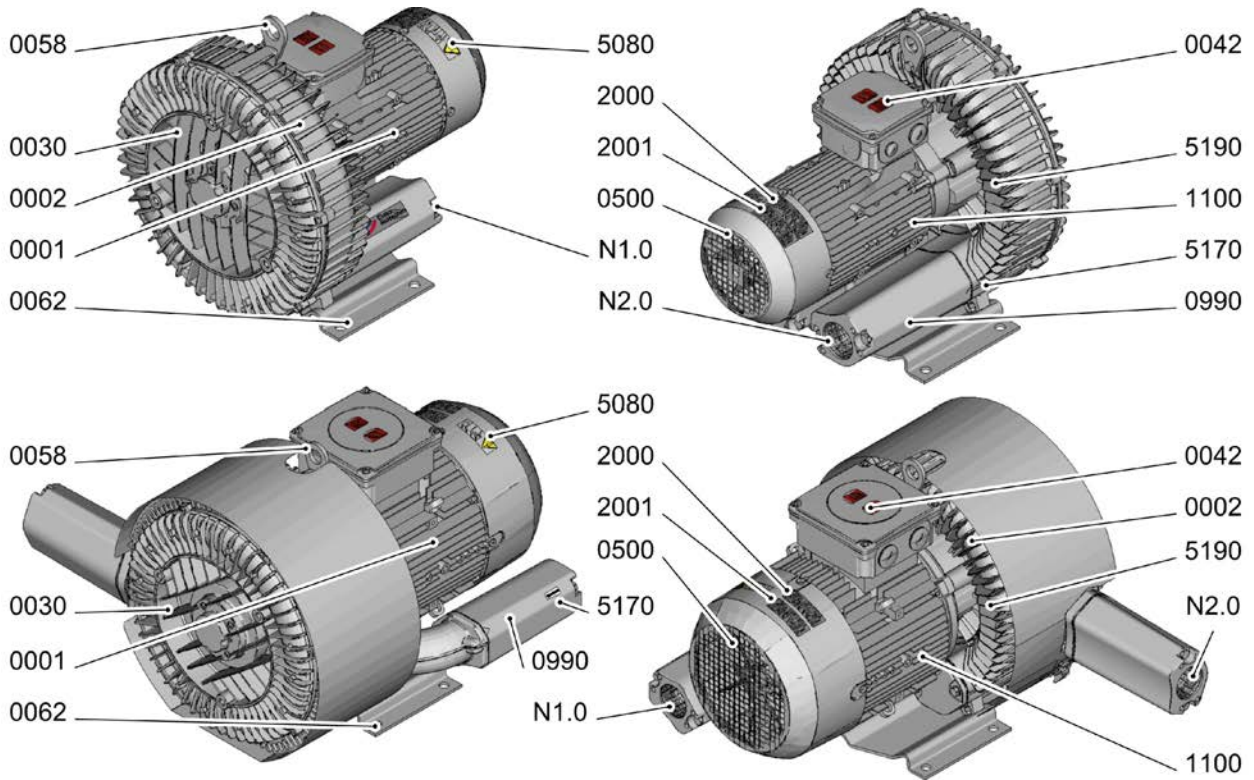

- | | |
|----------------------------------|-------------------------------------|
| 0001 Drive motor | 1100 External earth connection * |
| 0002 Compressor housing | 2000 Compressor rating plate |
| 0030 Compressor cover | 2001 Motor ATEX rating plate |
| 0042 Junction box | 5080 Adhesive label with CE marking |
| 0058 Eye bolt/lifting attachment | 5170 Direction of conveyance arrow |
| 0062 Foot | 5190 Direction of rotation arrow |
| 0500 Fan guard | N1.0 Gas inlet |
| 0990 Silencer | N2.0 Gas outlet |

* Position may vary, see dimensional drawing for details

3.4 Versions and options

The G-BH1N ATEX can be delivered with the following options

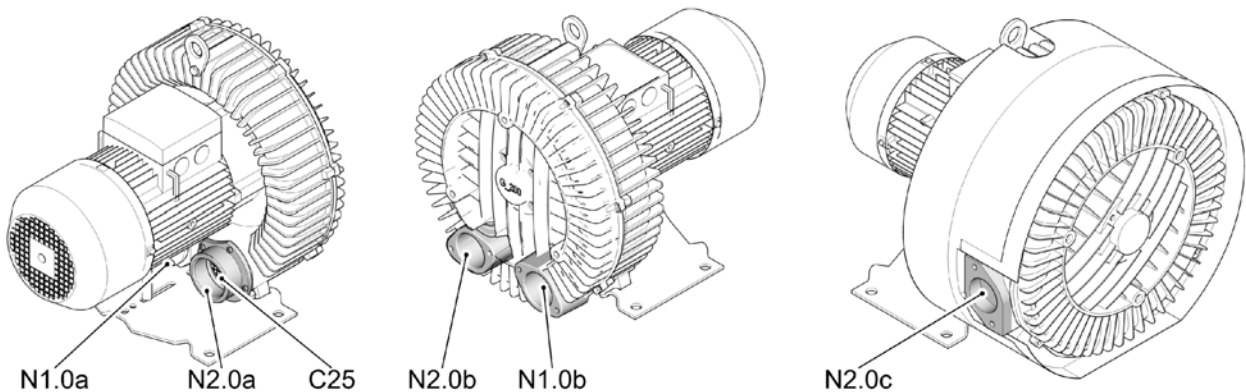

- | | |
|---|--|
| N1.0a Gas inlet without silencer and with flange | N1.0b Gas inlet, cover side |
| N2.0a Gas outlet without silencer and with flange | N2.0b Gas outlet, cover side |
| C25 Protective grid (option C25) | N2.0c Side gas outlet without silencer |

3.5 Ancillaries

The following original accessories are available from the manufacturer

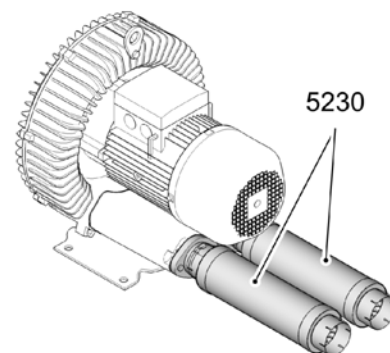
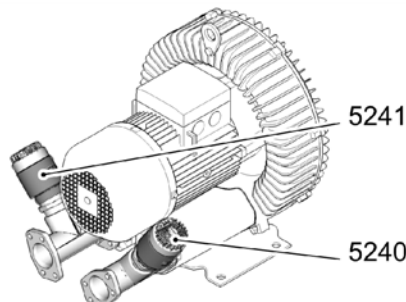
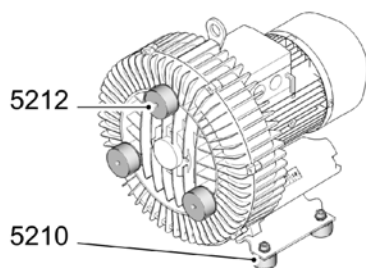

5210 Foot-mounted spring elements
5212 Cover-mounted spring elements
5230 Additional silencers

5240 ATEX pressure limiting valve
5241 ATEX vacuum shut-off valve

3.6 Function principle

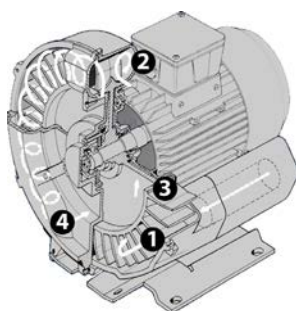

The side-channel compressor consists of a drive (motor) and a compressor part in which an impeller rotates contact-free in the side-channel.

Side-channel compressors can be used as a vacuum pump or are used as the compressor (observe Correct use of the equipment [→ 8]).

As soon as the motor is switched on, conveyed media is suctioned via the gas inlet (1).

When it enters the side-channel the conveyed media is accelerated in the direction of rotation by the blades of the rotating impeller (3).

The centrifugal force presses the conveyed media to the inner wall of the side-channel (2). From there, the conveyed media is supplied to the impeller blades again.

With every renewed entry of the conveyed media into the impeller, it gains kinetic energy and the pressure increases.

The cross section of the side-channel is limited at the interrupter.

In this manner, the conveyed media is stripped from the impeller blades and expelled via the gas outlet (4).

3.7 EC/EU declaration of conformity

Manufacturer	Gardner Denver Deutschland GmbH Industriestraße 26, 97616 Bad Neustadt, Germany
Representative for the compilation of technical documents	Holger Krause, Gardner Denver Deutschland GmbH Industriestraße 26, 97616 Bad Neustadt, Germany
Designation of the machine	Compressor/vacuum pump
Series	G-BH1N ATEX
Types	2BH1...-1.D 2BH1...-1.G
Option M74/M75 *	CE Ex II 3/3G Ex h ec IIB T3 Gc II 3/3D Ex h tc IIIB T125°C Dc

**Gardner
Denver**

* The notified body DEKRA Testing and Certification GmbH, no. 0158, has filed the technical documentation and issued the following certification: BVS 21 ATEX E 015 X

The manufacturer bears sole responsibility for issuing this declaration of compliance. The machine described above complies with all applicable harmonisation legislation of the Community:

2006/42/EC, OJ L 157, 9.6.2006	Directive 2006/42/EC of the European Parliament and of the Council of 17 May 2006 on machinery, and amending Directive 95/16/EC
2014/34/EU, OJ L 96, 29.03.2014	Guideline 2014/34/EU of the Council of February 26th 2014 on the harmonisation of the laws of the Member States concerning equipment and protective systems intended for use in potentially explosive atmospheres (EXAT)
2011/65/EU, OJ L 174, 1.7.2011	Directive 2011/65/EU of the European Parliament and of the Council of 8th June 2011 on the restriction of the use of certain hazardous substances in electrical and electronic equipment (taking into account all delegated acts/directives including 2015/863)

harmonised standards and other technical specifications on which the declaration of compliance is based:

EN 1012-1:2010	Compressors and vacuum pumps - Safety requirements - Part 1: Compressors
EN 1012-2:1996 +A1:2009	Compressors and vacuum pumps - Safety requirements - Part 2: Vacuum pumps
EN ISO 12100:2010	Safety of machinery - General principles for design - Risk assessment and risk reduction (ISO 12100:2010)
EN 1127-1:2019	Explosive atmospheres - Explosion and protection - Part 1: Basic concepts and methodology
EN IEC 60079-0:2018	Explosive atmospheres - Part 0: Equipment - General requirements
EN 60079-7:2015/ A1:2017	Explosive atmospheres - Part 7: Equipment protection by increased safety "e"
EN 60079-31:2014	Explosive atmospheres — Part 31: Equipment dust ignition protection by enclosure 't'
EN ISO 80079-36:2016	Non-electrical equipment for explosive atmospheres - Basic method and requirements
EN ISO 80079-37:2016	Non-electrical equipment for explosive atmospheres - Non-electrical type of protection constructional safety "c", control of ignition sources "b", liquid immersion "k"
EN 60204-1:2018	Safety of machinery; electrical equipment for machinery part 1: General requirements IEC 60204-1:2016 (amended)

3 Product identification



Signed for and on behalf of: Gardner Denver Deutschland GmbH

Bad Neustadt, 25.11.2021

(Place and date of issue)

A handwritten signature in black ink, appearing to read 'C. Seit', enclosed in a thin black rectangular border.

Caroline Seit, Operations/Authorised signatory

(Name and function)

A handwritten signature in black ink, appearing to read 'Markus Kopf', enclosed in a thin black rectangular border.

Markus Kopf, Product & Market Manager

(Name and function)

664.00165.40.200

4.1 Unpacking and checking the condition of delivery

The G-BH1N ATEX is secured onto a pallet and protected by a cardboard box for delivery.

1. Remove the packaging, except for the transport protection on the connection openings.
2. Check the delivery for transport damage.
NOTICE! Report any transport damage to the manufacturer immediately.
3. Check that the delivery matches the order.
4. Remove fastening screws on the foot (item 0062, [→ 17]).
NOTICE! The transport spring elements attached to the machine cannot be used for the installation as they may have been damaged during transport. Dispose of transport spring elements.
5. Dispose of packaging material in accordance with the valid local regulations.

4.2 Lifting and transporting

⚠ **WARNING**

Danger of crushing and cutting!

Danger of crushing and cutting of body parts due to tipping or falling loads during transportation.

1. Only transport G-BH1N ATEX in a horizontal position (exception: 2BH1943).
2. The load-bearing capacity of the lifting gear and load-handling equipment must correspond to the mass [→ 49].
3. Secure against tipping over or falling.
4. Do not remain under supported loads.
5. Set up the G-BH1N ATEX on a stable and level surface.

NOTICE

Mechanical damage!

G-BH1N ATEX can be damaged during transportation.

- ! The G-BH1N ATEX is designed for transport with a crane or forklift.
- ① The G-BH1N ATEX should not be exposed to impacts and blows during transportation.

The type of transportation depends on the mass:

- G-BH1N ATEX up to **20 kg** (44 lbs) **without** lifting attachment/eye bolt: Transportation by hand **NOTICE! Observe the health and safety requirements!**
- G-BH1N ATEX over **20 kg** (44 lbs) **with** lifting attachment/eye bolt: Transportation with a crane

Transport with crane (except for 2BH1943)

! The eye bolt/lifting attachment is exclusively designed for the mass of the G-BH1N ATEX including original accessories.

! The G-BH1N ATEX on the compressor cover (item 0030, [→ 17]) must be placed horizontally for transportation with lifting attachment (item 0058, [→ 17]).

1. Guide the lifting strap between the compressor housing (item 0002, [→ 17]) and the motor (item 0001, [→ 17]) through openings or on edges.

⚠ WARNING! Make sure that the lifting strap cannot slip off!

2. Lift the G-BH1N ATEX until the lifting strap is taut.
3. Tilt the G-BH1N ATEX with one or two people on the foot, depending on the type.

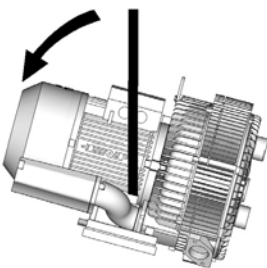

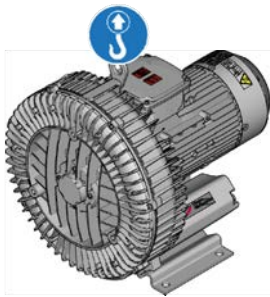

4. Check that the eye bolt/lifting attachment is firmly fastened and retighten as necessary.
 - ✓ M8: **18 – 22 Nm** (13.3 – 16.2 ft lbs)
 - ✓ M12: **18 – 42 Nm** (13.3 – 31.0 ft lbs)
 - ✓ M16: **138 – 165 Nm** (102 – 122 ft lbs)
5. Attach the crane hook to the eye bolt/lifting attachment.
6. Lifting and transporting the G-BH1N ATEX.
7. Set the G-BH1N ATEX down and, if necessary, secure from slipping and falling.
8. Remove the lifting device.

Transporting the 2BH1943 with a crane

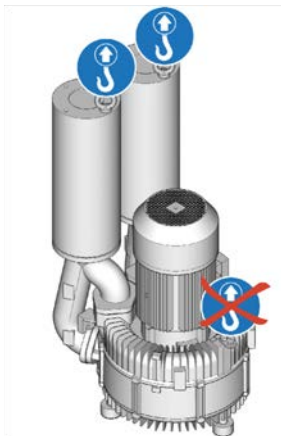

1. Screw an eye bolt into each silencer (item 0990, [→ 17]) - not included in scope of delivery.
 - ✓ M16: **138 – 165 Nm** (102 – 122 ft lbs)
2. Attach the crane hook to the eye bolts.
3. Lifting and transporting the G-BH1N ATEX.
4. Set the G-BH1N ATEX down and, if necessary, secure from slipping and falling.
5. Remove the lifting device.

4.3 Storage

NOTICE

Mechanical damage and corrosion!

Failure to adhere to the storage conditions can lead to mechanical damage and corrosion, as well as shorten the grease service life.

1. Adhere to the storage conditions.
 2. The maintenance intervals of the ball bearings (Maintenance [→ 44]) become shorter as the time of storage increases.
-
1. Connect all suction vents so that no dirt or solid particles can enter.
 2. Turn the rotor once per year so as to avoid permanent standstill marks.
 3. If the storage conditions specified in the table cannot be met, suitable corrosion protection, preservation, packaging and drying measures must be taken.

Storage conditions	Permitted values	
Ambient pressure	Atmospheric	
Composition of the environment	Dry, dust-free environment (relatively humid <60 %)	
Ambient temperature	-15 °C to +40 °C	+5 °F to +104 °F
Static loads	None	
Abrupt impacts	None	
Speed of oscillation V_{eff}	<1.5 mm/s	<0.059 in/s

5.1 Measures after long-term storage

Replace ball bearings and radial shaft seal

! If the length of storage until assembly is exceeded by **4 years** under the storage conditions specified in Storage [→ 22].

1. Replace [→ 44] the rolling bearing.
2. Clean adjacent bearing areas for open ball bearings and re-grease.
3. Replace and grease the radial shaft seal.

If the bearing conditions vary (Storage [→ 22]), a reduced ball bearing service life is to be expected.

Measuring the motor insulation resistance

1. Measure the insulation resistance of the motor at 500 V DC voltage and +40 °C wrapping temperature between the conductors of the main circuit and protective conductive system.
 - ✓ Value $\geq 5 \text{ M}\Omega$: no measures necessary.
 - ✓ Value $< 5 \text{ M}\Omega$: Dry winding.

Converting to the reference temperature

For wrapping temperatures other than +40 °C, convert the measured value to the reference temperature of +40 °C using the following equations.

$R_C = (0.5)^{(40-T)/10} * R_T$	R_C	Insulation resistance converted to a +40 °C reference temperature
	40	Reference temperature in °C
	T	Measuring/wrapping temperature in °C
	10	Halving/doubling the insulation resistance by 10 K
	R_T	Measured insulation resistance at measuring/wrapping temperature T in °C

- The insulation resistance is halved for every 10 K temperature increase.
- The resistance is doubled for every 10 K drop in temperature.

Option K45/K46: Measuring the electric band heater insulation resistance

1. Measure the electric band heater insulation resistance against the machine housing at 500 V DC voltage.
 - ✓ Value $\geq 1 \text{ M}\Omega$: no measures necessary.
 - ✓ Value $< 1 \text{ M}\Omega$: Dry the electric band heater.

5.2 Mounting conditions



! WARNING

During operation, the system pressure ensures that there is conveyed material in the motor and junction box!

The conveyed material can escape through the condensate drain hole (Option L12) and form an explosive mixture. Opening the junction box can release a mixture of conveyed material and air, and form an explosive mixture.

① For conveyed media other than air, take leaks from the G-BH1N ATEX into account (e.g. forced ventilation, gas monitoring).

For safe operation of the G-BH1N ATEX:

- The environmental conditions according to Directive 2014/34/EU must correspond to the protection class of the motor.
- Always secure the G-BH1N ATEX to an even (± 0.5 mm) installation surface or base frame using screws. The dimensions and load-bearing capacity must be designed for the G-BH1N ATEX (see dimensional drawing).
- When installing outdoors, take protective measures against the effects of weather.
- When installing in enclosed spaces, ensure that there is sufficient ventilation. For conveyed media other than air, take leaks from the G-BH1N ATEX into account (e.g. forced ventilation, gas monitoring).
- Exhaust air from other machines must not be sucked in by the motor fan.
- Spark-generating parts must not fall onto the G-BH1N ATEX (e.g. protective roof, no storage of parts above the G-BH1N ATEX).
- No external vibrations, shock loads or accelerations are permitted.
- No external mechanical loads are permitted on the G-BH1N ATEX and its attachments (e.g. support the piping, and do not climb the G-BH1N ATEX or its attachments).
- If there is a risk of condensation forming in the interior of the G-BH1N ATEX, take protective measures (e.g. heating, moisture separators).

Option K23: G-BH1N ATEX without painting

- ! G-BH1N ATEX that are delivered unpainted do not offer sufficient corrosion protection.
1. Prior to installation, paint the G-BH1N ATEX with paint that is suitable for the application.
 2. The paint must meet the requirements for avoiding the build-up of electrostatic charges, see IEC 60079-0 and ISO 80079-36. Any existing primer must be taken into account.

5.3 Reduction of oscillations and noises

Noise emissions and vibrations can be reduced by the following measures:

- Do not set up the G-BH1N ATEX in set-up areas that conduct or radiate sound.
- Equip installation surfaces with intermediate layers of conductive noise damping material.
- Use additional silencer (item 5230, [→ 18]).
- When installing horizontally, use spring elements on the foot (item 5210, [→ 18]).

5.4 Mounting

The following installation positions are permitted by the manufacturer:

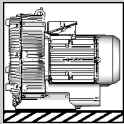
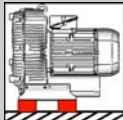
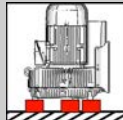
Type	Without spring elements	With spring elements	
		Item 5210, [→ 18] 	Item 5212, [→ 18] 
2BH1 with frequency inverter	✗	✓	✓ ¹
2BH11..	✓	✓	✓ ¹
2BH12..	✓	✓	✓ ¹
2BH13..	✓	✓	✓ ¹
2BH14..	✓	✓	✓ ¹
2BH150. 2BH153. 2BH159.	✓	✓	✓ ¹
2BH151.	✗	✓	✓ ¹
2BH16..-1A.1. -1A.3. 2BH164.-1G.4. -1G.5.	✓	✓	✓ ¹
2BH161.-1H...	✗	✓	✓ ¹
2BH18..	✓	✓	✓ ¹
2B1940-1....	✓	✓	✓ ¹
2BH19..-1A.1. -1A.3. 2BH191.-1H.3.	✗	✓	✓ ¹
2BH1943	✗	✗	✓ ¹

¹ Not a function of the condensate drain hole in the motor (Option L12). Carrying moisture and condensate along with the conveyed material reduces the service life of the rolling bearings.

5.4.1 Level assembly on the foot

1. Mark the fixing points through the holes in the foot (item 0062, [→ 17]) or by referring to the dimensional drawing.
2. Lift the G-BH1N ATEX away and drill the holes for the fixing points.
3. Place the G-BH1N ATEX with the foot in assembly position.
4. Screw the foot to all anchorage holes with fastening elements.
 - ✓ M8 steel (8.8 according to ISO 898-1): **18 – 22 Nm** (13.3 – 16.2 ft lbs)
 - ✓ M10 steel (8.8 according to ISO 898-1): **35 – 42 Nm** (25.8 – 31.0 ft lbs)
 - ✓ M12 steel (8.8 according to ISO 898-1): **58 – 70 Nm** (42.8 – 51.6 ft lbs)

5.4.2 Vertical mounting on the compressor cover



WARNING

Explosion hazard due to spark formation from falling objects!
In the case of vertical installation on the compressor cover, objects can fall through the fan guard onto the motor fan and cause sparks.

- ① In the case of vertical installation on the compressor cover, objects must be prevented from falling into the motor fan (e.g. cover with sufficient distance, see Minimum distances for heat dissipation [→ 48]).

5 Installation

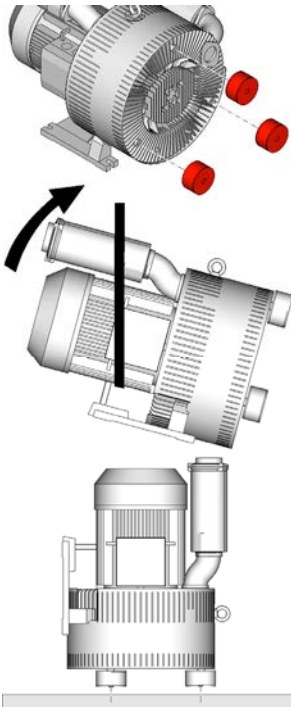

- ! Spring elements (item 5212, [→ 18]) must be used in order to mount vertically on the compressor cover (item 0030, [→ 17]).
1. Mark the threaded holes for the cover position (item N8.8, [→ 17]) based on the dimensional drawing.
 2. Drill the holes for the fixing points.
 3. Screw the threaded studs of the spring elements into the threaded holes for the cover position.
 - ✓ Tighten securely: 11 – 22 Nm
 4. Lift the G-BH1N ATEX and tilt it with **two** people onto the compressor cover.
 5. Place the G-BH1N ATEX with the compressor cover in the assembly position.
 6. Screw the G-BH1N ATEX to the mounting surface using the threaded hole in the spring elements and securing elements.
 - ✓ M8: **8,5 – 12,5 Nm** (6.27 – 9.20 ft lbs)
 - ✓ M10: **17 – 25 Nm** (12.6 – 18.4 ft lbs)
 - ✓ M12: **30 – 43 Nm** (22.2 – 31.7 ft lbs)
 7. Remove the lifting device.

5.5 Fit loose silencer

! The silencers are enclosed separately for two-stage and twin-flow G-BH1N ATEX or for cover suction and have to be installed.

1. Remove transport protection.



WARNING

Danger of explosions!

The isolated assembly of silencers can lead to explosions that cause fatal injuries due to electrostatic discharge.

① Silencers must be fitted with an earth conduction resistance of $<10^6$ Ohm.

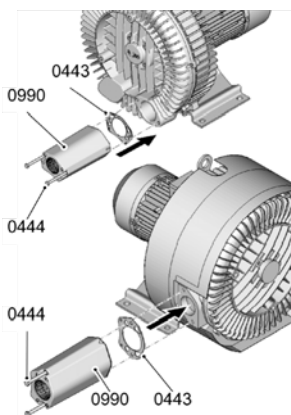

1. Check that the seal (0433) is securely fastened to the silencer (0990) and re-position seal, if necessary.
2. Position the silencer on the compressor cover or centre body
 - ✓ Observe the alignment of the silencer!
3. Screw in the silencer using the screws (0444).
 - ✓ M6: **7.5 – 9.0 Nm** (5.55 – 6.65 ft lbs)
 - ✓ M8: **18 – 22 Nm** (13.3 – 16.2 ft lbs)

5.6 Mount the accessories



⚠ WARNING

Danger of explosions!

The isolated assembly of accessories can lead to explosions that cause fatal injuries due to electrostatic discharge.

1. Accessories must be fitted with an earth conduction resistance of $<10^6$ Ohm.
 2. In potentially explosive environments, only fit accessories that do not pose an ignition source.
-
1. Mount accessories according the instruction manual supplied with the respective accessory.

5.7 Connecting pipelines and hoses



⚠ WARNING

Danger of explosions!

Static charge and leaks in piping, hoses and connections can lead to explosions that cause fatal injuries.

1. Avoid or minimise flexible pipe connections.
2. Piping and hoses must be fitted with an earth conduction resistance of $<10^6$ Ohm.
3. Mount piping and hoses in such a way that no dust or gas can enter or escape.
4. Protect piping and hoses against damage, e.g. by means of spatial arrangement or protection against impact.



⚠ WARNING

Danger of explosions!

Friction sparks due to intruding foreign matter or foreign objects and temperature increases due to dust deposits can lead to explosions that cause fatal injuries.

- ① For potentially explosive areas, install filters approved for the respective zone (particle size <10 μm) in the suction line.

⚠ WARNING

Risk of injury due to uncased gas outlet and gas inlet!

Serious injuries to body parts, drawing in of hair or projected hot conveyed media or particles.

- ! Operation without piping and/or without silencers (free suction and/or free blowing pressure side) is solely permitted if the following measures are taken:
1. Install a protective grid (Option C25) in the gas outlet and gas inlet.
 2. Take protection measures on the gas inlet to prevent hair from being sucked in.
 3. On the gas outlet, secure the danger area from hot conveyed media and projected particles with deflection plates or a collection basket.
 4. Provide sound protection measures.

 **WARNING**
Risk of injury due to overpressure!

Suddenly ejected conveyed media such as impurities and solid particles or pressure surges can lead to serious injuries.

1. Dimension pipes and hoses, securing elements, fittings and containers sufficiently and align them to the maximum pressures.
2. Connect the G-BH1N ATEX and the system de-energised and flexibly (e.g. using hoses or compensators).
3. Do not fit pipes, hoses, securing elements, fittings and containers to the G-BH1N ATEX and secure from damage.
4. Protect the G-BH1N ATEX from non-permitted pressure levels from the plant (e.g. pressure limiting valve, pressure switch).
5. When operating the compressor, the pressure on the gas outlet must be indicated via a pressure indicator.
6. After switching off, ensure that no conveyed media can flow through the G-BH1N ATEX (external drive through conveyed media), install a check valve if necessary.

 **WARNING**
Risk of burns due to temperatures of up to approx. 125 °C [257 °F]!

Contact with hot surfaces, pipes and hoses, can lead to burns.

1. Fit pipes and hoses with sufficient distance from highly inflammable materials (e.g. wood, plastic).
2. Cover hot surfaces, such as pipes and hoses, with protection (e.g. perforated metal cover or wire covering) or isolate them.
3. Hot surfaces, such as pipes and hoses, that do not have their own safeguard, are supplied with warning signs.

NOTICE**Pressure loss due to reduced cross section of the pipes and hoses!**

- ① As possible, make the cross section of the pipes and hoses the same length or longer than the connections of the G-BH1N ATEX.

The conveyed material is sucked in via the gas inlet (item N1.0, [→ 17]) and discharged via the gas outlet (item N2.0, [→ 17]). The direction of conveyance of the conveyed media is marked by a conveyance arrow (item 5170, [→ 17]).

Connection dimensions and tightening torques for gas inlet (item N1.0) and gas outlet (item N2.0, [→ 17])

Type	Pipe thread			Direct connection			Hose connection
	ISO 228	ANSI/ ASME B 1.20.1	[Nm (ft lbs)]	Opening [mm (in)]	Distance between screws [mm (in)]	[Nm (ft lbs)]	[mm (in)]
2BH11 2BH13	G 1¼	---	35 – 60 (25.8 – 44.2)	Ø 39 (1.54)	Ø 64 (2.52)	M6: 7,5 – 9,0 (5.55 – 6.65)	Ø 40 (1.58)*
2BH12 2BH14	G 1½	---	40 – 70 (29.5 – 51.6)	Ø 46 (1.81)	Ø 72 (2.84)	M6: 7,5 – 9,0 (5.55 – 6.65)	Ø 50 (1.97)*
2BH15.. 2BH16..	G 2*	NPT 2-8*	58 – 90 (42.8 – 66.4)	Ø 55 (2.17)	Ø 83 (3.27)	M8: 18 – 22 (13.3 – 16.2)	Ø 50 (1.97)* Ø 60 (2.36)*
2BH18..	G 2½*	NPT 2½-8*	70 – 110 (51.6 – 81.1)	Ø 80 (3.15)	Ø 108 (4.25)	M8: 18 – 22 (13.3 – 16.2)	Ø 90 (3.54)*
2BH1900 – 2BH1940	G 4*	NPT 4-8*	100 – 165 (73.8 – 122)	Ø 100 (3.94)	Ø 150 (5.91)	M12: 58 – 70 (42.8 – 51.6)	Ø 115 (4.53)*
2BH1943	G 5*	NPT 5-8*	138 – 200 (102 – 147)	Ø 130 (5.12)	Ø 210 (8.27)	M16: 138 – 165 (102 – 122)	Ø 150 (5.91)*
	* Option C28	* Option C29					* Option C41

! On delivery, all connection openings are closed with a transport protection. This prevents foreign objects from entering.

1. Remove the transport protection from the connection openings.
2. For impurities in the conveyed media, fit a filter (accessories) in the suction line.
3. Install a check valve if the conveyed media can flow through the G-BH1N ATEX while at a standstill (external drive through conveyed media).
4. **NOTICE! When connecting pipe threads, secure the connection points against turning.**
5. Connect the pipe or hose of the system suction line to the gas inlet (item N1.0, [→ 17]).

6.1 General installation regulations



⚠ DANGER

Lethal electric shock due to contact voltage on the housing!

1. Implement protection from contact voltage according to IEC 60204-1. Use the earth connection in the terminal box (equipotential bonding protection).
2. Connect the equipotential bonding function to the outer earth connection (item 1100, [→ 17]) with an earth conduction resistance of $<10^6$ Ohm.
3. Keep the terminal box free of foreign objects, dirt and moisture.
4. Seal terminal box lid and cable feed openings so that they are dust and water tight.

NOTICE

Destruction of the drive!

Incorrect operation or incorrect control can destroy the drive.

1. The G-BH1N ATEX is equipped with an **asynchronous motor**.
2. Operating on a grid with a non-earthed start point is not permitted.

The electrical installation must properly fulfil the requirements of IEC 60204-1, IEC 60204-11 and IEC 61010-1.

The electrical installation must properly fulfil the ATEX requirements of IEC 60079-14 or IEC 60079-17.

The electrical installation must also be implemented according to the applicable national, local and plant-specific stipulations, as well as the requirements of the power supply company.

The conditions at the place of use must comply with the details on the rating plate (item 2000, [→ 16]) and on the ATEX motor rating plate (item 2001, [→ 16]).

The following conditions are permitted during mains operation:

- ± 5 % variation in voltage without loss of performance (range A, IEC 60034-1) according to the compressor rating plate (item 2000 , [→ 16])
- ± 10 % variation in voltage with loss of performance (range B, IEC 60034-1) according to the compressor rating plate (item 2000 , [→ 16])
- ± 2 % deviation in frequency
- Deviations are indicated on the rating plate of the compressor (item F, [→ 16])

The electrical installation must:

- Be designed in accordance with the ambient and operating conditions (ampacity)
- Be correctly attached and protected.
- Be kept away from hot surfaces.
- Be electrically isolated to a sufficient degree.
- Be constructed and fitted in such a way that the following faults do not lead to damage:
 - short circuits
 - mechanical impacts
 - power supply failures or surges
 - electromagnetic fields
 - earth connections

The electrical equipment and control unit must not disable the safety equipment for the drive system and the motor protection (e.g., PTC resistor, frequency inverter current limit).

When the power supply fails or surges, the control must prevent the G-BH1N ATEX from remaining in operation or starting up.

Protective devices and switches must fulfil the failure safety conditions.

Overcurrent protection

The power supply of the motor must be equipped with an overcurrent protection (e.g. motor protection circuit breaker) that is permitted for the respective zone and certified for the corresponding protection type.

Set the overcurrent protection device to the maximum current in continuous operation (item H₁, [→ 16]).

Separator for the electrical energy supply

A separator for the electrical energy supply must be:

- Provided according to IEC 60204-1, 5.3 and 5.5.
- Clearly and visibly labelled.

6.2 Additional installation requirements for frequency inverters

This section only applies to G-BH1N ATEX with option M75.

The operating instructions of the SINAMICS G120 frequency inverter and the SINAMICS G120 frequency inverter manufacturers certificate (Other valid documents [→ 7]) must always be observed.



WARNING

Danger of explosions!

Using G-BH1N ATEX and frequency inverters that are not permitted can lead to explosions with fatal injuries.

1. Use only G-BH1N ATEX with option M75 for operation with a frequency converter.
2. Only use frequency inverters that comply with the frequency inverter certificate of compliance Other valid documents [→ 7].

The G-BH1N ATEX can be operated on SINAMICS G120 frequency inverters provided the permitted voltage peaks are observed. The insulation system of the G-BH1N ATEX meets the requirements of IEC 60034-18-41 according to stress category C (IVIC C = high stress).

G-BH1N ATEX with ignition protection type “ec” for increased safety

Operating the G-BH1N ATEX on the frequency inverter is permitted if the specifications on the rating plate for ATEX motor with frequency inverter [→ 16] are observed. The winding temperature must be monitored via the built-in temperature sensors in connection with a trip unit approved for the respective zone.

G-BH1N ATEX with ignition protection type “tc” for dust explosion protection

These G-BH1N ATEX are generally equipped with 3 PTC resistors according to DIN 0898-1-401 (DIN 44082) with a nominal response temperature depending on the max. possible surface temperature. Select the trip units for the PTC resistors in accordance with this standard. If the temperature of the cable glands is not specified on the rating plate, then it is max. 70 °C. Use appropriate cables for this temperature. Do not exceed the maximum frequency stamped on the rating plate, which depends on the number of contacts.

System with frequency inverter - cable - electrical machine

Follow indications from IEC 60034-17 and IEC 60034-25 with regard to winding stress. In the case of public networks with an operating voltage up to 690 V, the maximum value of the voltage peaks at the end of the cable must not exceed twice the value of the intermediate circuit voltage in the frequency inverter.

Interference when operating on the frequency inverter

When operating on the frequency inverter, various types of interference can occur. For G-BH1N ATEX with built-in sensors (e.g., PTC resistor), the frequency inverter can cause interference in the sensor wiring. This can cause malfunctions that result in death, serious physical injuries, or material damage.

1. Comply with the EMC instructions provided by the manufacturer of the frequency inverter. This will prevent the limits from being exceeded in accordance with IEC 61000-6-3 for the drive system, consisting of the G-BH1N ATEX and frequency inverter.
2. The screening for a screened machine supply line is most effective when it is connected to the metal junction box on the machine via a large-area conductive connection (with a metal screw connection).

Resistance to interference from external factors

In principle, the G-BH1N ATEX fulfils the requirements for resistance to interference laid out in IEC 61000-6-2. For sensors, such as PTC resistors, the sensor signal wiring (if applicable, screened and connected as with machine supply line) and evaluation units being used must be sufficiently resistant to interference.

When operating the machines on the frequency inverter at higher speeds than the rated speed, adhere to the mechanical speeds [→ 47] (safe operating speed IEC 60034-1).

6.3 Controls

Controls and instruments must be constructed and arranged in such a way that:

- They are easily visible and accessible, and can also be operated without excessive effort.
- The operator understands the functions.
- Operating faults are prevented.

A control system must correspond to ISO 12100, 4.11; IEC 60204-1, 9.4; IEC 60079-17 and ISO 13849-1.

When the power supply fails, a "system with oriented failure mode" according to ISO 12100, 6.2.12.3 must be used.

Start and stop devices must be clearly marked in accordance with ISO 13850 and IEC 60417.

EMERGENCY OFF function

An EMERGENCY OFF function must be provided when a dangerous situation can occur that must be rectified manually (see ISO 12100, 6.3.5.2)

- Implement the EMERGENCY off function according to EN 418 and EN 50099.
- Implement a manual EMERGENCY OFF function according to ISO 13849-1, 5 (in particular 5.2.1).
- The stop category and colour of the EMERGENCY OFF function must correspond to ISO 13850.
- If a risk assessment determines that the normal switch can fulfil the EMERGENCY OFF function, this should be labelled accordingly.

After an EMERGENCY OFF, start-up is only possible via a deliberate, manually-triggered procedure.

Manual reset

A manual reset after a stop command must correspond to ISO 13849-1, 5.5.2 and IEC 60204-1, 9.2.5.3 and 9.2.5.4.

Start and new start

The requirements of a start and new start, must correspond to ISO 13849-1, 5.2.3.



If the G-BH1N ATEX is equipped with an automatic or remote-controlled start control, it must be labelled with the sign to the left.

It is necessary to prevent an automatic or remote-controlled start during maintenance or repair.

6.4 Connect the motor to the mains



WARNING

Danger of explosion due to potentially explosive dust atmosphere!

- ① The terminal box and motor must not be opened in a potentially explosive dust atmosphere.



WARNING

Danger of explosions!

Connection cables are not usually gas-tight. As such, conveyed media can be squeezed into external parts of the power supply (e.g. electrical cabinet). An explosive mixture can form there from the conveyed media and the environment and lead to explosions that cause fatal injuries.

! When using conveyed media that can form explosive mixtures when they come into contact with the environment:

1. depressurise connection cables within defined zones.

OR

2. use pressure-tight connectors.

OR

3. install forced ventilation in external parts of the power supply.

OR

4. install gas monitoring with forced switch-off in external parts of the power supply.

Option K45/K46: Blocking circuit for electric band heater

! When the electric band heater is operated with the G-BH1N ATEX running, damage can occur due to increased temperatures in the G-BH1N ATEX.

1. Use a blocking circuit, which switches the electric band heater off when the machine is switched on.
2. Only switch the electric band heater on after the machine is switched off.

Option A11/A12: PTC resistor for winding monitoring device

Use a trip device approved for the respective zone to monitor the PTC resistor.

Monitoring circuit	Trip device
Temperature sensor (PTC resistor Option A11/A12)	According to the specifications on the certificate for the corresponding trip unit and the electrical configuration, e.g. thermistor motor protection relay SIRIUS 3RN1011-.B, 3RN1011-.G, 3RN1012-.B, 3RN1012-.G, 3RN1013
Temperature sensor (KTY 84-130)	According to specifications on the certificate for the corresponding trip unit and the electrical configuration, e.g. SIRIUS motor management system SIMOCODE per 3UF7

The insulation for the temperature sensor is designed for winding in accordance with the requirements for basic insulation. The connections of the temperature sensor are insulated in the terminal box and are not separated safely.

⚠ DANGER! Therefore, in the event of an error, the voltage on the sensor cable can be dangerous, and touching it could lead to death, serious physical injuries, or material damage.

1. When connecting the temperature sensor to an external sensor monitor, take any necessary additional measures to comply with the requirements laid out in IEC 60664-1 and IEC 61800-5-1 to protect against dangers due to electric shock.

Position of the terminal points for the PTC resistor (Option A11/A12) and/or electric band heater (Option K45/K46)

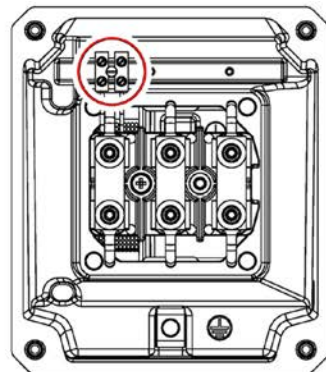



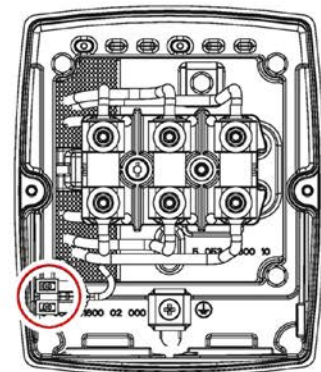

Variant A

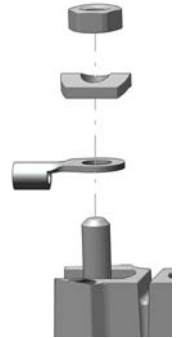
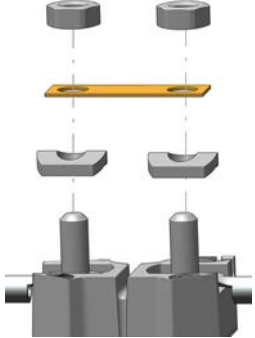
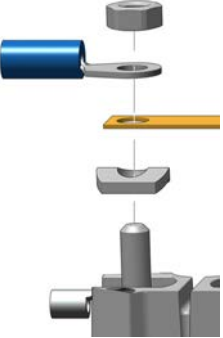
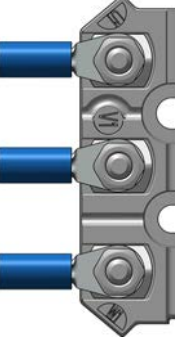

Variant B

1. Connect PTC resistor and/or electric band heater according to the circuit diagram in the junction box (item 0042, [→ 17]).

Terminal board designs

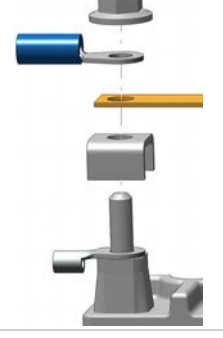
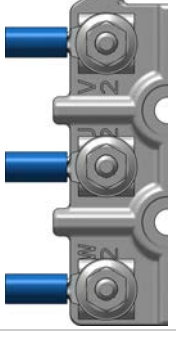
Terminal board design	Internal motor wiring		Customer connection / mains connection / plug	
	Motor connection cables	Connecting rail	Mains connection	Cable routing*
Variant A 				
Variant B 				

* Install cable lugs parallel to the terminal board cases/domes!

External earth connection

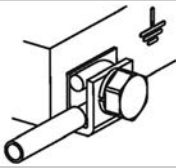
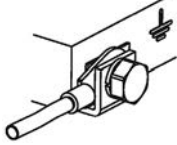
Housing earthing		Wire cross-section mm ²
Connection of a single conductor under external earthing bracket		≤ 10
Connection with cable under external earthing bracket		≤ 25

Minimum air gaps

Check and adhere to minimum air gaps between insulated parts after installation. Correct projecting cable ends.

Effective value for AC voltage U _{eff}	Minimum air gap [mm]		
	Ex tc Ex tb	Ex ec	Ex eb
≤ 250 V	3.0	2.5	5.0
≤ 500 V	3.0	5.0	8.0
≤ 630 V	5.5	5.5	10.0
≤ 1000 V	8.0	8.0	14.0

The values apply for an installation height of up to 2,000 m. When determining the required minimum air gaps, the voltage value in the table can be increased by a factor of 1.1, so that the rated voltage range is taken into account in general use.

Connect up the motor

1. Open the junction box cover.
2. Open necessary access points for cable glands.
3. Screw in or insert cable glands and secure with locknut. Screw in fit reducer, if necessary.
NOTICE! The cable glands and fit reducers must be permitted and marked for the respective zone (IEC 60079-14). Observe the manufacturer's specifications.
4. With the junction box turned, check the tightening torques of the junction box screw fittings.
 - ✓ M4: **4.0 – 5.0 Nm** (2.95 – 3.70 ft lbs)
 - ✓ M5: **7.5 – 9.5 Nm** (5.55 – 7.00 ft lbs)
5. Feed the cable to be connected through the cable glands and into the junction box (item 0042, [→ 17]).
6. Attach cable lugs to cable to be connected.
7. Connect the protective cable to the designated position with the symbol to the left.
 - ✓ M4: **4.0 – 5.0 Nm** (2.95 – 3.70 ft lbs)
 - ✓ M5: **7.5 – 9.5 Nm** (5.55 – 7.00 ft lbs)
8. Attach mains connecting line and connecting rails according to the circuit diagram in the junction box (item 0042, [→ 17]).
NOTICE! Refer to figures.
 - ✓ M4: **0.8 – 1.2 Nm** (0.60 – 0.90 ft lbs)
 - ✓ M5: **1.8 – 2.5 Nm** (1.35 – 1.85 ft lbs)
9. If available, connect PTC resistor and electric band heater according to the circuit diagram in the junction box (item 0042, [→ 17]).
10. Remove any unused parts (e.g. bridges, nuts) from the junction box.
11. Tighten cable glands according to manufacturer's specifications.
12. Seal unused openings with sealing plugs.
NOTICE! The sealing plugs must be permitted and marked for the respective zone (IEC 60079-14). Observe the manufacturer's specifications.
13. Close the junction box cover.
 - ✓ M4: **4.0 – 5.0 Nm** (2.95 – 3.70 ft lbs)
 - ✓ M5: **7.5 – 9.5 Nm** (5.55 – 7.00 ft lbs)



6.5 Connecting the frequency inverter to the mains

This section only applies to G-BH1N ATEX with option M75.

The operating instructions of the SINAMICS G120 frequency inverter and the SINAMICS G120 frequency inverter manufacturers certificate (Other valid documents [→ 7]) must always be observed.



WARNING

Danger of explosion or overheating due to electrical equalizing currents! When operating the frequency inverter, equalizing currents may flow through the G-BH1N ATEX depending on the assembly situation. If they are interrupted, the currents can generate ignitable sparks and/or impermissible heat.

- ① Take suitable measures to avoid the ignition source.



⚠ WARNING

Overheating of the G-BH1N ATEX

Operating explosion-protected G-BH1N ATEX on the frequency inverter without safety equipment can lead to death or serious physical injuries.

- ① Always use a PTC resistor monitor when operating explosion-protected G-BH1N ATEX on the frequency inverter. Use a trip device approved for the respective zone to monitor the PTC resistor.



⚠ CAUTION

Destruction of the isolation system due to excessive connection voltages!

1. The G-BH1N ATEX can be operated at mains voltages ≤ 500 V on the frequency inverter provided the permitted voltage peaks are observed.
2. Permitted voltage gradient ≤ 9 kV/ μ s.
3. $\hat{U}_{\text{Conductor-Conductor}} \leq 1500$ V, $\hat{U}_{\text{Conductor-Ground}} \leq 1100$ V.
4. Wavefront duration $t_s > 0,1$ μ s.

Maximum voltage peaks on the motor terminals

Measured motor voltage [V]	$\hat{U}_{\text{Conductor-Conductor}}$ [V _{pk}]	$\hat{U}_{\text{Conductor-Ground}}$ [V _{pk}]	Intermediate circuit U _{DC} [V]
≤ 500	1500	1100	750

Rise time depending on voltage level

Step size [V]	Minimum rise time t_r [ns]
900	100
1050	200
1260	400

Special conditions of use for frequency inverters in zone 2 and 22

The G-BH1N ATEX must only be powered by means of pulse width modulation via an intermediate circuit voltage inverter in compliance with the specifications on the rating plate [→ 16] and the following electrical parameters.

Electrical parameters for frequency inverter

Maximum permitted input voltage	Measured voltage for the motor (item O, [→ 16])
Minimum clock frequency	1.2 kHz
Maximum output current	$1.5 \times I_N$
Maximum overload/ time for operating under minimum frequency *	60 s
Output frequency	Up to 100 Hz

* The maximum overload and the permitted time for operating under minimum frequency refer to a time interval of 10 min.

When operating the frequency inverter, no excessive overvoltage is permitted on the motor terminals. The air clearance and creepage distance in the terminal box does not allow the frequency inverter to generate overvoltage with a periodic amplitude of more than 1500 V for measured voltages ≤ 1000 V. The motor insulation system might require the periodic overvoltage to be limited even further.

6.6 Connecting accessories

Connect accessories according to the instruction manual supplied with the respective accessory.

7.1 Measures after a long shut-down period

Replace ball bearings and radial shaft seal

- ! When the downtime exceeds **4 years** since the last commissioning.
- 1. Replace [→ 44] the rolling bearing.
- 2. Clean adjacent bearing areas for open ball bearings and re-grease.
- 3. Replace and grease the radial shaft seal.

If the standstill conditions vary (Storage [→ 22]), a reduced ball bearing service life is to be expected.

Measuring the motor insulation resistance

1. Measure the insulation resistance of the motor at 500 V DC voltage and +40 °C wrapping temperature between the conductors of the main circuit and protective conductive system.
 - ✓ Value $\geq 5 \text{ M}\Omega$: no measures necessary.
 - ✓ Value $< 5 \text{ M}\Omega$: Dry winding.

Converting to the reference temperature

For wrapping temperatures other than +40 °C, convert the measured value to the reference temperature of +40 °C using the following equations.

$R_C = (0.5)^{(40-T)/10} \cdot R_T$	R_C	Insulation resistance converted to a +40 °C reference temperature
	40	Reference temperature in °C
	T	Measuring/wrapping temperature in °C
	10	Halving/doubling the insulation resistance by 10 K
	R_T	Measured insulation resistance at measuring/wrapping temperature T in °C

- The insulation resistance is halved for every 10 K temperature increase.
- The resistance is doubled for every 10 K drop in temperature.

Option K45/K46: Measuring the electric band heater insulation resistance

1. Measure the electric band heater insulation resistance against the machine housing at 500 V DC voltage.
 - ✓ Value $\geq 1 \text{ M}\Omega$: no measures necessary.
 - ✓ Value $< 1 \text{ M}\Omega$: Dry the electric band heater.

7.2 Tests during commissioning or re-commissioning

 **CAUTION**

Overpressure!

Overpressure during the leak test can damage the G-BH1N ATEX.

- ① To test the plant for leaks, the G-BH1N ATEX must be excluded.

The following list of checks cannot be exhaustive. Additional checks may be required according to IEC 60079-17 and system-specific conditions.

1. Prior to commissioning or recommissioning of the G-BH1N ATEX, check that:
 - ✓ The G-BH1N ATEX is properly fitted and aligned.
 - ✓ Rotating components move freely.
 - ✓ Pipes and hoses are correctly connected.
 - ✓ Attachments, screw fittings and electrical connections are fixed at the given tightening torques.
 - ✓ The equipotential bonding is connected correctly.
 - ✓ The operating conditions match the rating plate details given above.

- ✓ The maximum speeds are monitored and adhered to through the control.
- ✓ Protection measures against accidental contact have been completed.
- ✓ Cooling air supply is not affected.

7.3 Check gap and direction of rotation

Check gap

1. Start to turn the fan impeller.
2. Check if the impeller turns freely or if grinding noises can be heard.
 - ✓ If no grinding noises can be heard, the G-BH1N ATEX can be started up.
 - ✓ If grinding noises can be heard, do not start up the G-BH1N ATEX. Identify and correct the causes of the grinding noises (Troubleshooting [→ 42]).

Test the direction of rotation of the compressor

1. Switch on the G-BH1N ATEX briefly and then switch it off again.
2. **⚠ WARNING! When the electrical connection is incorrect: Risk of injury as a result of being pulled or sucked in! Do not perform the overpressure test with your hands!**
Perform the overpressure test on the gas outlet using a piece of paper (item N2.0, [→ 17]).
 - ✓ Overpressure present: direction of rotation is correct, no measures
 - ✓ Negative pressure present: Direction of rotation incorrect, change direction of rotation by interchanging two phases of electrical supply line

7.4 Checking the sensors

1. Check the correct connection and function of the existing additional devices for machine monitoring.

7.5 Measure the acoustic emissions

- ! It is necessary to measure the acoustic emissions for G-BH1N ATEX without piping, without silencers or without piping.
1. Ensure that all persons in the potentially excessive noise area wear ear protection.
 2. Measure sound during operation.
 3. If necessary, implement sound protection measures (e.g. Reduction of oscillations and noises [→ 24], provision of ear protection, identification of noise areas).

7.6 Measure oscillations

- ! It is recommended to measure the oscillations for the prescribed operating speeds.
1. Measure oscillations.
 2. If the permitted Speed of oscillation [→ 48] is exceeded, provide measures for Reduction of oscillations and noises [→ 24].

WARNING
Danger of burns from hot surface on the unit and from hot conveyed media!

! On the surface of the G-BH1N ATEX, temperatures of approx. 125 °C [257 °F] are possible.

1. Do not touch hot surfaces during operation.
2. Allow to cool after removing from service.

WARNING
Danger of explosions!

Different operating conditions can cause temperature increases that are not permitted and thus lead to explosions that cause fatal injuries.

1. Adhere to the pressure differences given on the rating plate rating plate item p [→ 16].
2. The temperature of the conveyed material must not exceed 125 °C [257 °F] at the gas outlet (item N2.0, [→ 17]).
3. Choking the gas outlet and the gas inlet simultaneously is only permitted after consulting the manufacturer.

WARNING
Danger of explosions!

Risk of explosion due to failure to comply with safety requirements.

! The monitoring function of the sensors can switch off the G-BH1N ATEX.

- ① Search and correct the causes of the shut-down. Do not go below the safety level required by the device category.

WARNING
Danger of explosions!

Opening the G-BH1N ATEX/junction box or removing the labels can lead to ignition sources due to electrostatic discharge.

1. Do not open the G-BH1N ATEX and/or motor in explosive atmospheres.
2. Do not remove labels in explosive atmospheres.

When operating the G-BH1N ATEX, comply with the Permitted conditions for use [→ 47].

8.1 Switch on

1. Switch on current supply.
 - ✓ The G-BH1N ATEX begins to suction conveyed media.

8.2 Switch off

! The G-BH1N ATEX can be switched off in each operating condition (i.e. regardless of pressure, temperature, etc.). In doing so, the working process of the system must be observed.

8.3 Switch off in emergency

1. The G-BH1N ATEX can be switched off in emergency without any particular precautions.
 - ✓ If the brakes of the G-BH1N ATEX are actively employed, restarting in the opposite direction of rotation must be prevented.
2. Determine the cause.
3. Rectify the risk.
4. Put the G-BH1N ATEX back into operation [→ 38].

8.4 First inspection after installation or repair

1. After approx. 500 operating hours or after 6 months at the latest, carry out the following checks:
 - ✓ Electrical parameters are adhered to during operation.
 - ✓ The permitted temperatures of the surfaces are adhered to during operation.
 - ✓ Smooth running and running noises have not deteriorated.
 - ✓ The installation surface is free of cracks and dips.
2. Carry out further checks according to the system-specific conditions.
3. Immediately correct any deviations from the norm that have been detected.

Fault	Cause	Corrective measure	To be carried out by
G-BH1N ATEX does not start up and does not make any noise	The power supply of the G-BH1N ATEX was interrupted	Correct the break in fuses, terminals or power supply lines	Electrician
G-BH1N ATEX does not start up and makes noises	Break in one of the power supply lines	Correct the break in fuses, terminals or power supply lines	Electrician
	Stator winding interconnected	Check winding connection in junction box	Electrician
	Impeller and rotor blocked	Open G-BH1N ATEX, remove foreign objects, clean or replace parts	Service
	Rolling bearing is faulty	Replace rolling bearing	Service
G-BH1N ATEX turns unevenly	Defective motor cable	Check motor cable	Electrician
	Frequency inverter motor underexcited or overexcited	Check the parameterisation	Operating personnel
		Check motor data and if necessary, identify the motor	Operating personnel
Overcurrent protection triggered again after switching motor on; power consumption too high	Motor overloaded. Settings deviate from details on rating plate	Reduce settings	Fitter
	Winding short or phase short in the stator winding	Determine winding resistances and insulation resistances and repair after consulting the manufacturer	Electrician
	Clogged filters, silencer elements or connecting pipes/hoses	Clean filters, silencer elements and connecting pipes/hoses	Service
	Impeller grinds or rotor is jammed	Open G-BH1N ATEX, remove foreign objects, clean or replace parts	Service
G-BH1N ATEX does not reach the required speed or shows no or too little differential pressure	Incorrect direction of rotation	Check the direction of rotation.	Electrician
	Fluctuating density of conveyed media.	Take into account recalculation of pressure values; consult the manufacturer.	Manufacturer
	Clogged filters or silencer elements	Clean filters and silencer elements and replace them, if necessary	Fitter
	Leaks in the unit	Seal the unit	Fitter
	Radial shaft seal is defective	Replace the radial shaft seal	Service
	Change in the blade profile due to contamination	Clean the impeller, check for wear and replace if necessary	Service
Abnormal flow noises	Flow rate too high.	Clean pipe/hoses, use pipes/hoses with a larger cross section if necessary	Fitter
	Silencer inserts dirty or faulty	Clean the silencer inserts, check for wear and replace as necessary	Service
Abnormal running noises or vibrations that improve after switching off	Electromagnetic cause (e.g. voltage unbalance)	Check electrical supply	Electrician

Fault	Cause	Corrective measure	To be carried out by
Abnormal running noises or vibrations that do not improve after switching off	Feet (item 0062, [→ 17]) or foot mount loose or defective	Check tightening torques and tighten screws Replace feet or foot mount	Fitter
	Spring elements (item 5210/5212, [→ 17]) defective	Replace spring elements	Fitter
	Ball bearing degreased or defective	Relubricate or replace the rolling bearing	Service
	Other imbalance (e.g. system resonance)	Correct the cause of the imbalance	Service
G-BH1N ATEX leaks	Screw connections loose	Check tightening torques and tighten screws	Fitter

10.1 Maintenance



⚠ WARNING

Danger of explosions!

Measures that are not compliant with ATEX can cause explosions with fatal injuries.

- ! Before carrying out any maintenance, make sure there is no potentially explosive atmosphere.
- 1. The G-BH1N ATEX should only be opened by specialised personnel for maintenance repair.
- 2. Prevent electrical charging of plastic parts.
- 3. **Do not** use compressed air for cleaning.
- 4. After disassembling or assembling the G-BH1N ATEX, conduct the prescribed tests and inspections.

For the safe operation of the G-BH1N ATEX, the following maintenance intervals are recommended. They are dependent on the operating conditions and must be adjusted by the user as necessary.

Maintenance interval	Maintenance measure	To be carried out by
Regularly, depending on the amount of dirt	1. Exterior: Check surfaces and attachments for deposits and clean if necessary.	Operating personnel
	1. Interior: Check any areas that convey material for deposits and clean or replace if necessary.	Maintenance staff
Weekly for conveyed media that are poisonous or harmful to health	1. Check G-BH1N ATEX for increased leaking. One of the following procedures can suffice for the inspection: <ul style="list-style-type: none"> ✓ Check for smears, ice formation, odours and noises resulting from leakage. ✓ Check using a mobile leak detection device or portable gas sensor equipment. ✓ Continuous or periodical monitoring of the atmosphere using fitted automatic measuring devices with a warning function. 	Operating personnel
Regularly, depending on the legal requirements and according to the manufacturer's specifications	<ol style="list-style-type: none"> 1. Check the function of the equipotential bonding and restore if necessary. 2. Check the control for error messages by disconnecting the sensors (e.g. bimetal switch, PTC resistor). Remedy the cause of the error for any malfunctions. 3. Check that the monitoring sensors are working and replace if necessary. 	Electrician
20,000 h or 2.5 years Exceptions 40,000 h or 4.5 years for: 2BH18..-1.G 2BH18..-1.D	<ol style="list-style-type: none"> 1. Replace the rolling bearing. 2. Replace the radial shaft seal. <p>Maintenance intervals were established based on reference conditions [→ 4]. Different ambient and operating conditions increase (e.g. lack of continuous operation, lower pressure differences) or reduce (e.g. operation with a frequency converter, rapid accelerations, vibrations, extended storage periods) the values. Detailed statements are only possible when taking the actual ambient and operating conditions into consideration.</p>	Service

10.2 Repairs and complaints

Please consult the service department regarding repairs and complaints before sending them to the manufacturer.

- Gardner Denver Deutschland GmbH
Industriestraße 26
97616 Bad Neustadt
Tel.: +49 9771 6888 2000
Fax: +49 9771 6888 11 2000
E-mail: er.service-nes@irco.com
Internet: www.gd-elmorietschle.com

10.3 Ordering spare parts

Spare parts order as per repair manual [→ 7].

11.1 Decommissioning



DANGER

**Lethal electric shock from G-BH1N ATEX with drive control!
The frequency inverter continues to be live after the intermediate circuit voltage has been switched off, and slowly becomes de-energised.**

1. After switching it off, wait for **at least 3 minutes**.
2. Before opening the frequency inverter, ensure that it is de-energised.

! The G-BH1N ATEX can remain in the unit or be dismantled for storage.

1. Allow the G-BH1N ATEX to cool, if necessary.
2. Disconnect the G-BH1N ATEX from the power supply.
3. Depressurise the pipes.

11.2 Disassembly

1. Disconnect the G-BH1N ATEX from all electrical connections.
2. Dismantle the piping and hoses.
3. Close connections that are open.
4. Loosen the G-BH1N ATEX from the installation surface.
5. Store [→ 22] or dispose of [→ 46] G-BH1N ATEX.

11.3 Disposal

WARNING

**Burns, chemical burns or poisoning!
Risk of injury due to contact with residual hazardous substances in the G-BH1N ATEX.**

① Decontaminate the G-BH1N ATEX as instructed by the manufacturer of the hazardous substances.

1. Remove the G-BH1N ATEX according to the repair manual [→ 7].
2. Collect solvents, residual lacquer and grease and dispose of them in accordance with the valid local regulations.
3. Dispose of components according to the valid local regulations or recycle them.



12.1 Permitted conditions for use

Any deviations from the following **permissible operating conditions** must be agreed with the manufacturer.

12.1.1 Installation height

The maximum installation height is **1000 m above sea level** (3280 ft) provided no other installation height is specified on the rating plate under item F, [→ 16].

12.1.2 Rotational speeds

The motor slip is not taken into account when specifying the speeds (min^{-1}).

Maximum speeds for operation with no frequency inverter

Type	50 Hz [min^{-1}]	60 Hz [min^{-1}]
2BH1	3000	3600

Maximum speeds for operation with a frequency inverter

Type	Minimum*		Maximum	
	[min^{-1}]	[Hz]	[min^{-1}]	[Hz]
2BH1	2200	37	3600	60

* Standby operation without conveying is permitted at 600 rpm (10 Hz)

12.1.3 Temperatures

Temperature of the conveyed media

Version	Minimum		Maximum	
	[°C]	[°F]	[°C]	[°F]
Standard	-15	+5	+40	+104
Option C11	-15	+5	+45	+113
Option C12	-15	+5	+50	+122
Option C13	-15	+5	+55	+131
Option C15	-15	+5	+60	+140

Ambient temperature

The G-BH1N ATEX may only be operated in the following ambient temperatures (T_{amb}) that deviate from EN 60079-0.

Version	Minimum		Maximum	
	[°C]	[°F]	[°C]	[°F]
Standard	-15	+5	+40	+104
Option C11	-15	+5	+45	+113
Option C12	-15	+5	+50	+122
Option C13	-15	+5	+55	+131
Option C15	-15	+5	+60	+140

12.1.4 Pressure differences

Pressure differences that can be generated in operation by G-BH1N ATEX

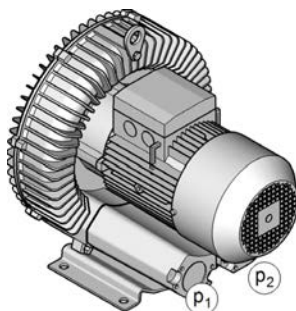

Maximum compressor operation [mbar]	Maximum vacuum operation [mbar]
Item p ₂ , [→ 6]	Item p ₁ , [→ 16]

The pressure differences specified on the rating plate serve as reference conditions [→ 6] and have a tolerance of ±10 %.

Loss of piping must be considered.

Mechanical damage or premature failure of G-BH1N ATEX due to inadmissible pressure loads!

① A long-term, **constant pressure load** at standstill can degrease the rolling bearing.

12.1.5 Relative humidity

The relative humidity of the environment is permitted up to a maximum of **60 %** at **+40 °C** (+104 °F).

Condensate formation is not permitted in the internal space of the G-BH1N ATEX.

12.1.6 Minimum distances for heat dissipation

Adhere to the following minimum distances for heat dissipation:

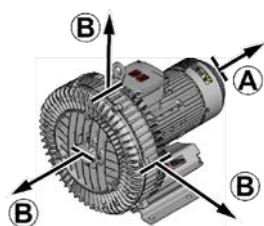

Type	A [mm]	B [mm]
2BH11 – 2BH14	35	20
2BH15	55	20
2BH16	55	30
2BH18 – 2BH19	55	40

12.1.7 Speed of oscillation

Maximum permissible oscillation speed for the assembled G-BH1N ATEX

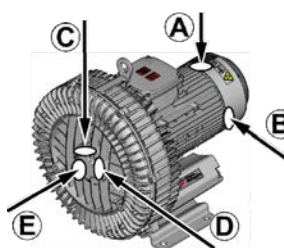

Installation	[mm/s]	[in/s]
Rigid (e.g. foundation)	2,8	0.110
Flexible (e.g. spring elements)	4,5	0.177

The oscillation speed must be determined at the following measuring points

- on the motor side
 - vertically (fan guard screw connection - A)
 - horizontally (fan guard screw connection - B)
- on the compressor part
 - vertically (compressor cover - C)
 - horizontally (compressor cover - D)
 - axially (compressor cover - E)

12.1.8 Accelerations

Maximum permissible acceleration for the constructed machine
0.3 x g

NOTICE! The rolling bearings can be destroyed by excessive alternating stresses.

12.2 Electrical data

Any deviations from the following **electrical data** must be agreed with the manufacturer.

The electrical data are provided on the ATEX motor rating plate [→ 16].

12.2.1 Increased operating cycle frequency

The G-BH1N ATEX is designed for heavy-duty operation. Consultation with the manufacturer is necessary for increased operating cycle frequency.

12.3 Weight

Type	[kg]
2BH1100	10.5
2BH1200	9.0
2BH1300	11
2BH1310	15
2BH1330	12.5
2BH1400 2BH1430 2BH1490	22
2BH1410	36
2BH1500 2BH1530 2BH1590	34
2BH1510	68
2BH1600 2BH1630 2BH1690	55
2BH1610 2BH1640	87
2BH1800 2BH1830	143
2BH1810 2BH1840	208
2BH1900 2BH1930	255
2BH1910 2BH1940	335
2BH1943	363

12.4 Acoustic emissions

Emission sound pressure level L_{pA} according to noise test code ISO 2151 with reference to the basic standard ISO 3744. Measured at a distance of **1 m** [3.28 ft] for 70 % Δp_{max} and connected supply lines, tolerance ± 3 dB(A).

Type	50 Hz	60 Hz
	[dB(A)]	[dB(A)]
2BH110	52	55
2BH120	57	61
2BH130	53	56
2BH131	55	61
2BH133	53	56
2BH140 2BH149	63	64
2BH141	66	69
2BH143	63	64
2BH150 2BH159	64	70
2BH151	72	74
2BH153	64	70
2BH160 2BH169	69	72
2BH161	73	76
2BH163	69	72
2BH164 2BH166	74	78
2BH180	70	74
2BH181	74	78
2BH183	70	74
2BH184	74	78
2BH190	74	79
2BH191	74	84
2BH193	75	80
2BH1940	75	84
2BH1943	75	84



www.gd-elmorietschle.de
er.de@gardnerdenver.com

**Gardner Denver
Deutschland GmbH**
Industriestraße 26
97616 Bad Neustadt · Deutschland
Tel. +49 9771 6888-0
Fax +49 9771 6888-4000

Elmo Rietschle is a brand of Gardner Denver

**Gardner
Denver**

Your Ultimate Source for Vacuum and Pressure