

**Liquid Ring Compressors  
Engineered-to-Order Compressor Systems**



# NASH Liquid Ring Compressors

## Greatest Performance Range of Liquid Ring Compressors Worldwide

The ability to compress wet, saturated or dirty gases is essential in many industrial applications. To deal with these challenges, liquid ring compressors are the number one choice. Due to the liquid ring technology, they can handle highly toxic, explosive and corrosive gases.

Nash provides its customers with reliable, quality liquid ring compressors with the features and performance necessary for all demanding applications. Whether it is flare gas compression, Vinyl Chloride Monomer (VCM) recovery or any other type of wet, corrosive, dirty or explosive gas, the Nash product range can provide the right solution. Models are available as single and two stage compressors.

To deal with these process challenges, Nash compressors are available in a wide variety of materials. Of course, stainless

steel is the first material of choice, but these rugged machines can also be built in other sophisticated materials.

Nash products cover the greatest performance range of all liquid ring compressors worldwide. Depending on the machine and application, these compressors work on discharge pressures up to 15 bar abs. with a suction capacity of 1,500 m<sup>3</sup>/h or with a suction capacity of 16,000 m<sup>3</sup>/h, compressing gas to 2 bar abs. With more than 100 years of experience, Nash will find the right compressor for your application.

Nash Liquid Ring Compressors require minimal care and are known for an extremely low need for maintenance. They reduce power and operating costs by handling higher capacities with less energy

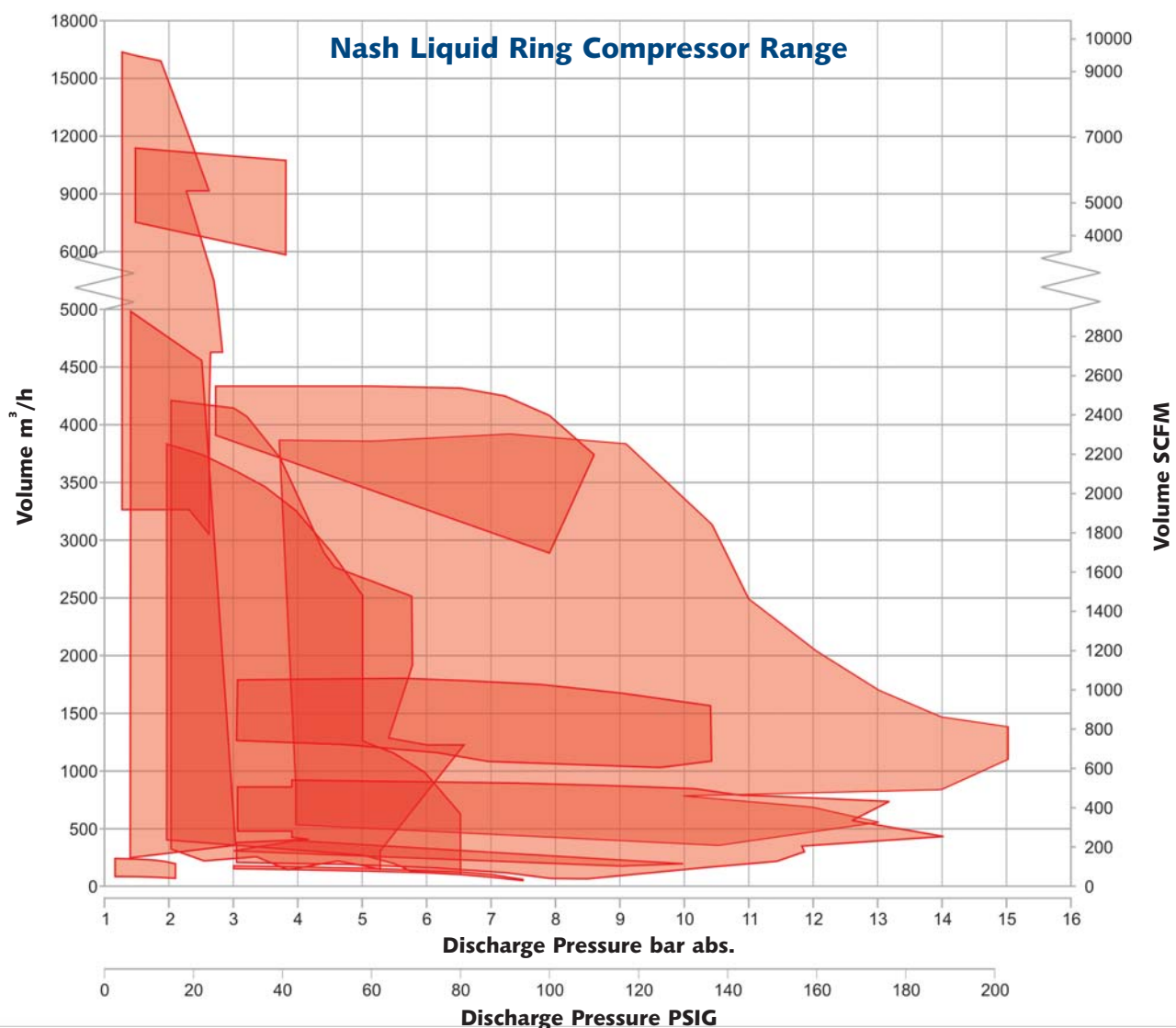

# NASH Liquid Ring Compressors

## High Pressure Liquid Ring Compressors

### NASH HP-9

Found primarily in petroleum refineries and chemical plants, these rugged and reliable compressors handle highly toxic, explosive and corrosive gases in applications such as flare gas and Vinyl Chloride Monomer (VCM) recovery.

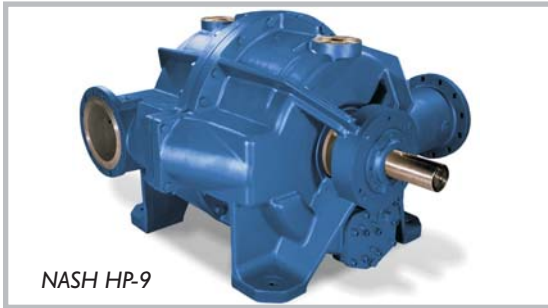

NASH HP-9

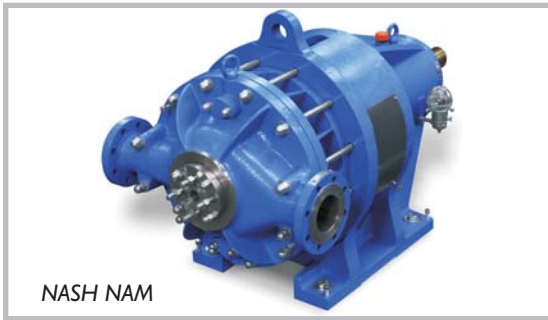

NASH NAM

Basic specifications NASH HP-9 (single stage compressor)	
Suction capacity	3,000 to 4,300 m <sup>3</sup> /h 1,800 to 2,500 CFM
Discharge pressure	to 8 bar abs. 100 psig
Mechanical seal	Single, double, cartridge
Construction materials	Stainless steel; other materials optional

Basic specifications	NASH NAM (single stage compressor)	NASH NAB (two stage compressor)
Suction capacity	100 to 3,600 m <sup>3</sup> /h 60 to 2,100 CFM	100 to 2,600 m <sup>3</sup> /h 60 to 1,500 CFM
Discharge pressure	to 6 bar abs. 72 psig	to 15 bar abs. 200 psig
Mechanical seal	Single, double, cartridge	
Construction materials	Stainless steel; other materials optional	

### NASH NAM/NAB

These high pressure liquid ring compressors are built for highly toxic, explosive and corrosive processes as well. They can handle dry and wet chlorine, ethylene, H<sub>2</sub>S, and many other condensable and non-condensable gases.

#### NAM - Single Stage Compressor

#### NAB - Two Stage Compressor

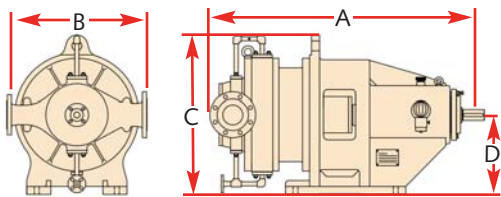

#### HP-9 - Single Stage Compressor

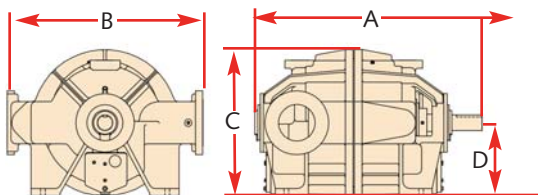

### Dimensions all dimensions are approximate

Pump Model	A inches mm	B inches mm	C inches mm	D inches mm	Gas Inlet Flange inches • mm	Gas Disch. Flange inches • mm
NAM 400	46.46 1180	27.56 700	31.5 800	15.75 400	4 100	3 80
NAM 600	49 1245	27.56 700	31.5 800	15.75 400	4 100	3 80
NAM 850	50.17 1274	27.56 700	31.5 800	15.75 400	4 100	3 80
NAM 900	57.59 1463	27.17 690	31.5 800	15.75 400	6 150	4 100
NAM 1100	53.25 1353	29.53 750	31.5 800	15.75 400	6 150	4 100
NAM 1500	75 1905	35.43 900	38.58 980	19.69 500	8 200	6 150
NAM 2500	77.94 1980	39.37 1000	42.52 1080	22.05 560	10 250	6 150
NAB 150	39.56 1005	17.72 450	20.27 515	9.84 250	2.5 65	1.5 40
NAB 250	41.47 1053	24.8 630	28.29 718	14.35 364	3 80	2 51
NAB 600	53.92 1370	27.56 700	31.5 800	15.75 400	4 100	3 80
NAB 850	54.59 1387	27.56 700	31.5 800	15.75 400	4 100	3 80
NAB 1100	64.63 1642	35.43 900	34.55 878	15.75 400	6 150	4 100
NAB 1500	73.82 1844	39.37 1000	40.16 1020	19.69 500	8 200	6 150
NAB 2500	91.34 2320	39.37 1000	44.1 1120	22.05 560	10 250	6 150
HP-9	62 1575	54 1372	40 1016	20 508	10 250	10 250



# NASH Liquid Ring Compressors

## Medium Pressure Liquid Ring Compressors

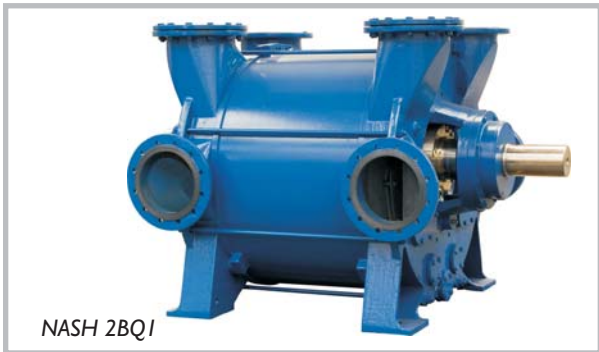

NASH 2BQ1

### Basic specifications NASH 2BQ 590

Suction capacity	6,000 to 11,000 m <sup>3</sup> /h 3,500 to 6,400 CFM
Suction pressure	0.8 to 1.5 bar abs. to 7 psig
Discharge pressure	1.5 to 3.75 bar abs. 7 to 40 psig
Construction materials	Ductile iron, stainless steel

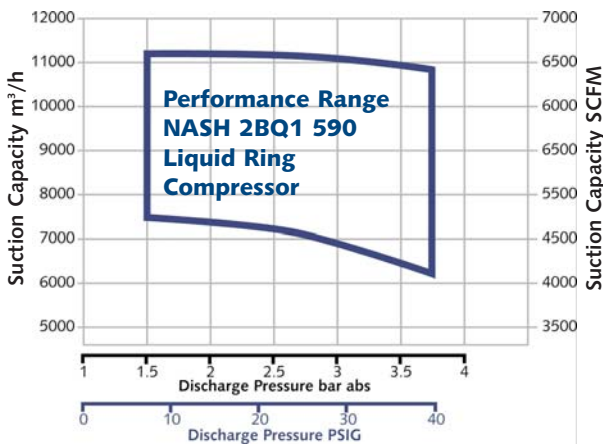

### NASH 2BQ

The world's first liquid ring compressors with high gas flow rates and discharge pressures of up to 3.75 bar abs. The NASH 2BQ1 590 has a unique performance range. It combines a high gas flow rate with a discharge pressure range of up to 3.75 bar abs., providing high efficiency. The performance data of this machine is unmatched by any other liquid ring compressor on the market.

The NASH 2BQ1 is based on the proven, modular NASH 2BE3 series and was developed with improved compressor configuration. Standard 2BE3 components can be used in many areas as a result.

The rotor, shaft and bearings were strengthened in order to withstand higher pressures. The NASH 2BQ1 is also designed for a wide operating speed range (420 to 611 rpm).

The shaft and housing are solid stainless steel, as are the mechanical shaft seals. Since every component can be made with application-specific stainless steels, the NASH 2BQ1 is the ideal liquid ring compressor for demanding process requirements. Applications include the recovery and compression of hydrocarbons and the compression of hydrogen, chlorine or other process gases.

The NASH 2BQ1 is certified for ATEX.

### Dimensions

Measurements in inches (mm)  
All dimensions are approximate

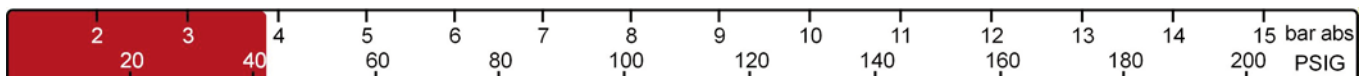
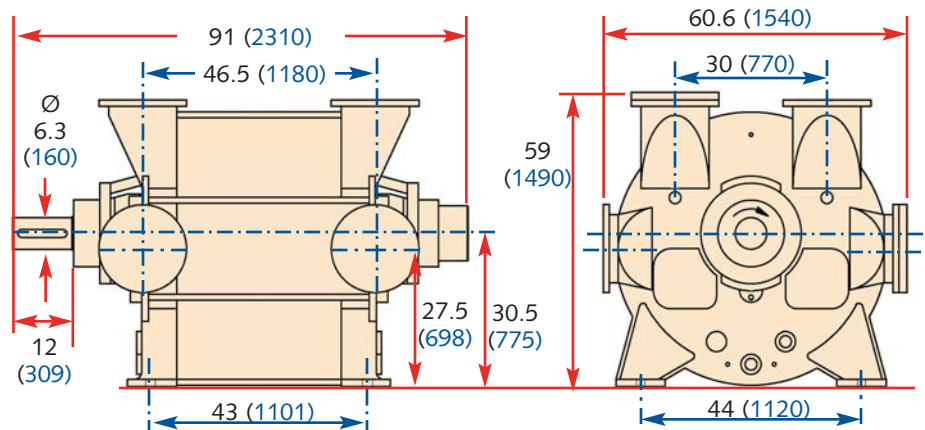

# NASH Liquid Ring Compressors

## Low Pressure Liquid Ring Compressors

### NASH 2BE4

When it is about compressing large volumes of gas, NASH 2BE4 compressors are the ultimate choice. These big machines are used for CO<sub>2</sub> compression in sugar mills, handle CO<sub>2</sub> with ammonia, compress coke oven gases, and fulfill many duties in the chemical process industry and many other applications.



#### Basic specifications NASH 2BE4 (Compressor)

Suction capacity	5,000 to 30,000 m <sup>3</sup> /h 3,000 to 17,600 CFM
Discharge pressure	to 2.5 bar abs. 22 psig
Mechanical seals	Single, double (on request), stuffing box
Construction materials	Ductile iron, stainless steel, combination of both materials

### NASH Vectra XL/GL

These rugged machines are usually found in the chemical process industry. They handle applications like waste gas and flue gas compression as well as the compression of SO<sub>2</sub>. NASH Vectra XL compressors also work reliably in many other applications.



#### Basic specifications NASH Vectra XL (Compressor)

Suction capacity	200 to 7,200 m <sup>3</sup> /h 120 to 4,300 CFM
Discharge pressure	to 3 bar abs. 30 psig
Mechanical seals	Single, double and cartridge
Construction materials	Ductile iron, stainless steel

### NASH Vectra SX

Due to advanced design and high reliability, the NASH Vectra SX is the right choice for compressing low volumes of gas up to low pressure. These highly efficient compressors are used for wastewater treatment, digester gas compression, aeration, gas boosting and in many other applications and industries



#### Basic specifications NASH Vectra SX (Compressor)

Suction capacity	45 to 230 m <sup>3</sup> /h 26 to 140 CFM
Discharge pressure	to 2.3 bar abs. 20 psig
Mechanical seals	Single
Construction materials	<ul style="list-style-type: none"> <li>Cast iron with precision cast 316 SS rotor and 304 SS lined body</li> <li>All precision cast 316 SS</li> </ul>

Most Nash vacuum pumps can also work as low pressure compressors. Please contact Nash for more information

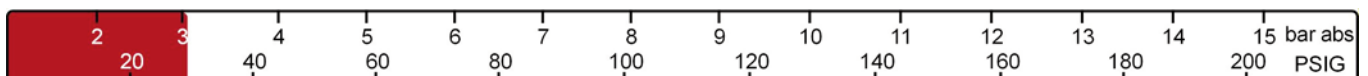

# NASH Liquid Ring Compressor Systems

## From Vacuum to Compression: Special Performance Compressors

Some applications require vacuum and compressor applications in one process. Instead of handling the gas with two separate machines, Nash compressors can do the job with only one pump. This reduces the cost and simplifies the installation.



NASH 2BG Ozone Compressor

### NASH 2BG

NASH 2BG two stage compressors have the ability to operate in processes that require both vacuum and compression. These compressors work reliably in batch and continuous processes from 300 mbar abs. to 6 bar abs. They can reach even higher discharge pressures when operating with a pressurized inlet. NASH 2BG compressors are also the first choice for the compression of ozone.

### NASH 2BK

NASH 2BK single stage compressors also function with negative and positive pressure inlets. These rugged compressors are relied on for the compression and recovery of hydrocarbons.

Basic specifications NASH 2BG (two stage)	
Suction capacity	50 to 1,750 m <sup>3</sup> /h 30 to 1,000 CFM
Suction pressure	0.3 to 2 bar abs. 9 in Hg (15 psig)
Discharge pressure	to 13 bar abs. 170 psig
Mechanical seals	Single or double with external flushing supply
Construction materials	Stainless steel and other materials

Basic specifications NASH 2BK (single stage)	
Suction capacity	150 to 4,200 m <sup>3</sup> /h 90 to 2,450 CFM
Suction pressure	0.8 to 2 bar abs. 24 in Hg (15 psig)
Discharge pressure	to 6 bar abs. 75 psig
Mechanical seals	Single with external flushing supply
Construction materials	Stainless steel and other materials

## Demanding Compressor Applications



NASH HP-9 Flare Gas Recovery Unit

Nash liquid ring compressors handle wet, saturated or dirty gases in many industrial applications. They can also handle highly toxic, explosive and corrosive seal liquids. Thanks to sophisticated materials and decades of superior expertise, Nash compressors work in:

- H<sub>2</sub>S Removal
- Dry and Wet Chlorine Compression
- Hydrogen Compression
- Hydrocarbon Recovery
- VCM Recovery
- Flare Gas Recovery
- Glycol Recovery
- Biogas Production and many other demanding applications

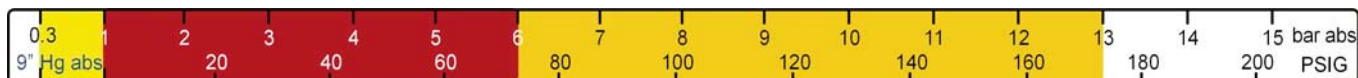

# NASH Liquid Ring Compressor Systems

## Engineered-to-Order Liquid Ring Compressor Systems



### Unmatched experience

Nash liquid ring compressors are the heart of our engineered-to-order compressor systems. Having built these rugged machines for nearly a century, we have unmatched experience in engineering custom-made liquid ring compressor systems for almost every application. Applying our know-how to our machines and systems provides superior value for our customers. Gardner Denver Nash is the leader of the field.

### Every process is different

There are unique requirements for every compressor system, whether it regards limited space requirements, gases and liquids used in a batch or continuous process or specialized instrumentation. We design your compressor system to match your requirements using state-of-the-art 3D CAD software.



### Highest standards

Gardner Denver Nash is committed to the highest standards in production and safety. We have many ISO certificates, issued to Nash facilities worldwide. We continuously improve our quality by optimizing our internal processes.

NASH compressors are certified to ATEX and other global industrial standards. Our global network of service and support is always available to keep your system running for years.

Features	Benefits
Ability to handle carryover	Minimal process problems resulting in more uptime; intended for severe applications
Long design life of 40+ years	Highest reliability
No internal lubrication required	Less maintenance required; less downtime
No metal-to-metal contact	Constant wear-free performance
Cool running - minimal temperature rise between inlet and discharge	Ideal for explosive gases and vapor recovery applications
Only one moving part	Simple and reliable operation

## Other NASH Products

### TC/TCM

Integral 2 stage liquid ring pumps with improved performance at vacuum levels down to 0.8" HgA (27 mbar)  
Designed to handle large amounts of liquid carryover without difficulty  
Capacity of 100 to 2,240 CFM with vacuum to 0.8" HgA  
Capacity of 170 to 3,740 m<sup>3</sup>/h with vacuum to 27 mbar abs



### Steam Jet Ejectors

Sizes range from one-inch (25mm) to 78-inch (2 meters) inlets  
Capacities range from 20 to 20,000 CFM  
Capacities range from 34 to 34,000 m<sup>3</sup>/h  
Multi-stage system pressures as low as 0.001 mm HgA



### 2BE4/P2620

Large liquid ring vacuum pumps with superior corrosion resistance  
Top discharge capability which eliminates need for trench  
Self-recirculating seal water, reducing need for external seal water source  
Capacity of 4,000 to 23,000 CFM with vacuum to 24" HgV  
Capacity of 6,800 to 39,000 m<sup>3</sup>/h with vacuum to 200 mbar abs



### Vectra

Liquid ring vacuum pumps and compressors  
Available in feature rich budget designs (SX, XL or GL)  
Designed to handle high back pressure requirements  
Capacity of 20 to 4,000 CFM with vacuum to 29+ HgV  
Capacity of 34 to 6,796 m<sup>3</sup>/h with vacuum to 33 mbar abs



### Service

We have the know-how, the expertise and the specialists. We provide professional service to make your pumps run for decades. Our service centers are located in:

- Australia
- Brazil
- China
- Germany
- Korea
- Netherlands
- Singapore
- South Africa
- Sweden
- UK
- USA



### NASH

#### Div. of Gardner Denver

9 Trefoil Drive  
Trumbull, CT 06611 U.S.A.  
phone: 800 553 NASH  
+1 203 459 3900  
fax: +1 203 459 3988  
nash@gardnerdenver.com  
www.GDNash.com

