

## Operating Instructions G-BH10

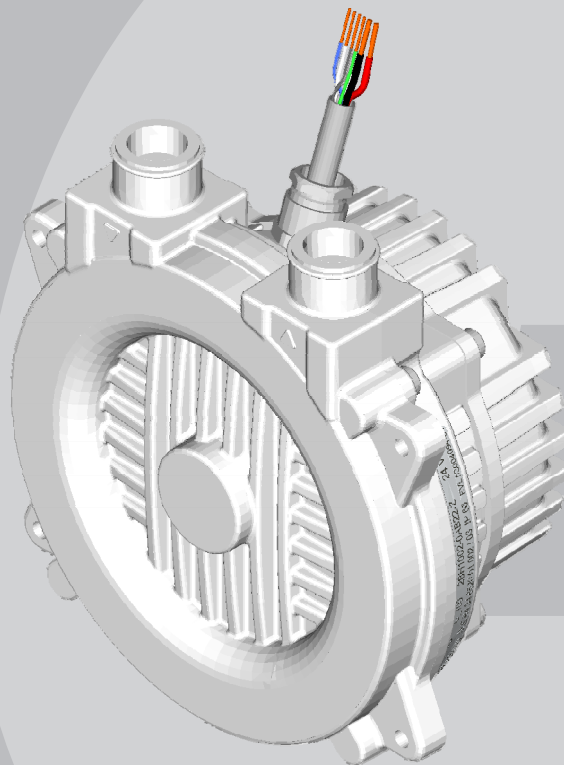

CE



**2BH10 02-.AB32**  
**2BH10 02-.AB22**  
**2BH10 02-.AA53**



**G-Serie**  
**G-Series**



















Seitenkanal  
Side Channel





## Table of Contents

1	Safety and Residual Risks.....	3
2	Intended Use .....	5
3	Technical Data.....	6
3.1	Nominal and Limiting Values Pump .....	6
3.2	Nominal and Limiting Values Motor and Electronics .....	7
4	Transport and Handling .....	9
5	Installation and Commissioning.....	10
5.1	Mounting .....	10
5.2	Connection .....	11
5.2.1	Electrical Connection (Motor).....	11
5.2.2	Pipe/ hose connections (pump) .....	17
5.3	Commissioning.....	18
6	Operation .....	19
7	Servicing .....	20
7.1	Maintenance.....	20
7.1.1	Cleaning .....	20
7.1.2	Inspection.....	21
7.1.3	Lubrication.....	21
7.2	Repair/ Troubleshooting.....	22
8	Shutting Down and Measures for Prolonged Standstill .....	23
	EC Declaration of Conformity .....	24



# 1 Safety and Residual Risks

	<p>Before beginning to work on the G-BH100 or the system carry out the following steps for both the G-BH100 and the entire system</p> <ul style="list-style-type: none"> <li>- switch off electricity,</li> <li>- lock against restart,</li> <li>- ensure absence of electricity,</li> <li>- ground and short-circuit installation,</li> <li>- cover or bar adjacent live parts,</li> <li>- depressurise both pipes and pump.</li> </ul>		<p>Operation of the G-BH100 only with the pipes / hoses connected to the suction and delivery branches!</p> <p><b>WARNING!</b></p> <p>In case of operation with open suction or delivery branches (drawing-in of gases from or discharge of gases into the surroundings) a piece of pipe or hose <b>with a length of at least 120 mm must by all means be</b> connected to the branch in question in order to prevent the impeller from being reached by fingers!</p> <p>Disassembly of the pipes / hoses connected to the suction and delivery branches only after the impeller has come to a complete standstill!</p> <p>Consider impeller run-out!</p>
	<p>Do not wear long, loose hair! Use a hair net! Never wear wide, loose clothes!</p>		
	<p>Transport and handling as well as assembly and disassembly may be carried out by trained and responsible personnel only!</p>		<p>Do not reach into the G-BH100 through open suction or delivery branches!</p> <p>Do not insert any objects into the G-BH100 through the openings!</p>
	<p>Operation of the G-BH100 only</p> <ul style="list-style-type: none"> <li>- with the gases as indicated in section 2, "Intended Use"!</li> <li>- with the values as indicated in section 3, "Technical Data"!</li> </ul>		<p>Operation of the G-BH100 only with the motor cap assembled!</p> <p>Disassembly of the motor cap is prohibited.</p>
	<p>Check pipes/hoses and vessels for sufficient strength!</p>		<p>Work on electrical installations may be carried out by trained and authorised electricians only!</p>
	<p>Check pipe / hose connections for tightness!</p>		<p>The electrical connections must be surrounded by a housing which is proof against foreign bodies, humidity, etc.!</p>
	<p>Operation of the G-BH100 only when completely assembled and securely fastened to the mounting surface!</p>		<p>Consider the life expectancy of the seals and gaskets!</p>
	<p>Check fasteners for secure fixing at regular intervals!</p>		<p>Ensure that no foreign bodies, humidity, etc. enter the motor interior!</p>
	<p>After loosening clampings and fastening elements some parts and components are only held in place by their centring or seatings or are no longer held in place at all so that they might fall down.</p> <p>Take the necessary care during disassembly and assembly!</p>		<p>For heat dissipation and cooling provide a <b>minimum distance of 15 mm</b> on each side except for the pump lid side on which a smaller distance of <b>at least 2 mm</b> is permissible!</p>
	<p>Operation of the G-BH100 only with the pump lid assembled!</p> <p>Disassembly of the pump lid only after the impeller has come to a complete standstill!</p> <p>Consider impeller run-out!</p>		<p>Burning and scalding hazard due to hot surfaces of the G-BH100!</p> <p>Do not touch during operation! Let the unit cool after shut-down!</p> <p>Provide a guard against accidental contact!</p>

	<p>The motor of the G-BH100 including its connecting leads must be protected against electrostatic discharge (ESD).</p> <p>Do not remove the ESD-prevention bag surrounding the lead ends until right before carrying out the electrical connection (attaching the connector, connecting to a terminal strip, or the like)!</p> <p>Carry out the electrical connection using the appropriate ESD-prevention equipment!</p>
---	--

	<p><b>Danger zone:</b> The vicinity of the unit during operation with open suction or delivery branches (drawing-in of gases from or discharge of gases into the surroundings)</p> <p><b>Hazard:</b></p> <ul style="list-style-type: none"> <li>• Injuries due to contact with pressurised fluids or due to sudden acceleration of parts.</li> <li>• Injuries due to parts thrown out of the unit.</li> </ul> <p><b>Protective measures:</b></p> <ul style="list-style-type: none"> <li>• Ensure that fluids discharged into the surroundings are not expelled close to people (e.g. work stations on machines)!</li> <li>• During work on or near the unit wear personal protective equipment!</li> </ul>
---	--

**Residual Risks**

	<p><b>Danger zone:</b> Hot surface.</p> <p><b>Hazard:</b> Burning / scalding hazard.</p> <p><b>Protective measures:</b> Attach warning sign "Warning of hot surface".</p>
	<p><b>Danger zone:</b> Impeller of the pump can be reached through open suction or delivery branches.</p> <p><b>Hazard:</b></p> <ul style="list-style-type: none"> <li>• Severing of limbs.</li> <li>• Drawing-in and entanglement of hair.</li> </ul> <p><b>Protective measures:</b></p> <ul style="list-style-type: none"> <li>• Operation only with the pipes / hoses connected to the suction and delivery branches! In case of operation with open suction or delivery branches (drawing-in of gases from or discharge of gases into the surroundings) a piece of pipe or hose <b>with a length of at least 120 mm must by all means</b> be connected to the branch in question!</li> <li>• Use a hair net!</li> </ul>

## 2 Intended Use

These operating instructions

- must be completely read and understood by all operating and servicing personnel before beginning to work with or on the G-BH100,
- must be strictly observed,
- must be available at the site of operation of the G-BH100,
- applies to Side channel blowers of the G-Series G-BH100,
- contains instructions bearing on transport and handling, installation, commissioning, operation, servicing, shut-down, and storage of the G-BH100.

The operating and servicing personnel working with or on the G-BH100:

- must be trained and authorised for the work to be carried out.
- Work on electrical installations may be carried out by trained and authorised electricians only.

The G-BH100

- are single-stage gas-ring vacuum pumps / compressors
- are machines used to generate vacuum or overpressure
- are used to extract, to deliver and to compress the following **pumped gases**:
  - air,
  - other gases, which are not explosive, flammable, aggressive or toxic
  - The pumped gases must not contain any solid bodies or impurities; those must be separated before entering the unit by means of a filter.
- exist in six fundamental designs<sup>1</sup>:
  - 2BH10 02-0AB32: hose connection with enclosed motor and integrated electronics
  - 2BH10 02-0AB22: hose connection with enclosed motor and integrated electronics
  - 2BH10 02-0AA53: hose connection with enclosed motor external electronics
  - 2BH1002-1....: flange connection
- are intended for industrial applications.
- are designed for continuous operation; in case of increased turn-on frequency or increased intake and ambient temperature the limiting overtemperature of the winding and the bearings must not be exceeded (operation only according to "Fig. 3", page 9).

When operating the G-BH100 it is imperative to observe the limiting values given in section 3, "Technical Data".

### Foreseeable Misuse



It is prohibited:

- to use the G-BH100 in applications other than industrial applications,
- to use the G-BH100 in areas where explosive atmosphere might occur,
- to extract, to deliver and to compress explosive, flammable, aggressive or toxic fluids,
- to operate the G-BH100 with values other than those given in section 3, "Technical Data".

Any unauthorised modifications of the G-BH100 are prohibited for safety reasons.

Maintenance work is only allowed to the extent described in these operating instructions.

Any further maintenance work as well as repair work may only be carried out by companies authorised by the manufacturer (please contact your sales engineer).

	<p><b>IMPORTANT!</b></p> <p>The G-BH100 is a component intended to be incorporated in a machine or system. It is delivered for this purpose to manufacturers of such machinery or systems (OEMs) only.</p>
	<p><b>IMPORTANT!</b></p> <p>The installation of the G-BH100 in your machine or system must be carried out in keeping with the requirements on electromagnetic compatibility according to the EMC Directive.</p>

<sup>1</sup> In order to determine the design of your G-BH100 refer to the type number (MLFB) on the rating plate.

### 3 Technical Data

#### 3.1 Nominal and Limiting Values Pump

G-BH100 with enclosed motor and	integrated electronics		external electronics
	2BH10 02-_AB32	2BH10 02-_AB22	2BH10 02-_AA53
Weight	1.2 kg [2.65 lbs]		1.5 kg [3.31 lbs]
Dimensions	see Fig. 1 & Fig. 2, page 8		
Sound level <sup>2</sup>	48 dB(A)	51 dB(A)	55 dB(A)
max. permissible total differential pressure <sup>3</sup> at +15°C:			
- vacuum pump operation <sup>4</sup>	100 mbar	105 mbar	185 mbar
- compressor operation <sup>5</sup>	105 mbar	105 mbar	190 mbar
max. permissible differential pressure between pump interior and surroundings	0.15 bar		
max. permissible intake and ambient temperature	+ 40°C [+104°F]		
max. permissible speed <sup>6</sup>	9,500 min <sup>-1</sup>	12,000 min <sup>-1</sup>	15,000 min <sup>-1</sup>
bearing life L10 <sup>7</sup>	20,000 h		
electrical data	see section 3.2, "Nominal and Limiting Values Motor and Electronics", page 7, and section 5.2.1, "Electrical Connection (Motor)", page 11		

#### Max. permissible dynamic load of the G-BH100 due to vibrations from outside:

Vibration frequency	Vibration value	
< 6.3 Hz	Vibration displacement	s ≤ 0.16 mm
6.3 Hz ... 63 Hz	Vibration velocity	v <sub>eff</sub> ≤ 4.5 mm/s
> 63 Hz	Vibration acceleration	a ≤ 2.55 m/s <sup>2</sup>

<sup>2</sup> Surface sound pressure level (EN ISO 3744), measured at a distance of 1 m [3.28 ft] at an operating point of approx. 2/3 of the permissible total differential pressure with the pipes / hoses connected and without vacuum or pressure limiting valve.

<sup>3</sup> Permitted only with: unobstructed cooling, an operating voltage of 24 V, a speed reference value of 10 V and left-handed rotation of the G-BH100.

The indicated **temperature** refers to the gas intake temperature. It is assumed that the gas intake temperature equals the ambient temperature of the G-BH100.

**IMPORTANT:** For the max. permissible total differential pressure at temperatures other than +15°C [+59°F] see "Fig. 3", page 9.

In case of **increased throttling** inside the suction or delivery pipe a pressure relief valve must be provided. In case of **reduced speeds** by means of a lower speed reference value the max. permissible total differential pressures change as well.

<sup>4</sup> Vacuum operation: extraction of air having the indicated temperature at the suction branch and a pressure of 1013 mbar at the delivery branch.

<sup>5</sup> Compressor operation: compression of air having the indicated temperature at the suction branch and a pressure of 1013 mbar at the delivery branch.

<sup>6</sup> Max. permissible speed due to the mechanical components and the design of the unit.

<sup>7</sup> For: operation within the permissible operating range, the max. permissible dynamic load due to vibrations from outside and fastening by means of **rubber / metal elements** (available as accessories).

### 3.2 Nominal and Limiting Values Motor and Electronics

G-BH100 with enclosed motor and	<u>integrated electronics</u>		<u>external electronics</u>
	2BH10 02-0AB32	2BH10 02-0AB22	2BH10 02-0AA53
Voltage range	14...28 V DC		38...52 V DC
Nominal voltage	24 V DC		48 V DC
Max. input current	4.5 A	5.2 A	7.0 A
Nominal speed	9,500 min <sup>-1</sup>	11,500 min <sup>-1</sup>	15,000 min <sup>-1</sup>
Speed control range	1,000 - 9,500 min <sup>-1</sup>	1,000 - 12,000 min <sup>-1</sup>	1,000 - 15,000 min <sup>-1</sup>
Rated power	90 W	115 W	300 W
Internal resistance at desired speed	70Ω		
Permissible ambient temperature	-10...+40°C [+14...+104°F]		
Relative humidity	max. 95 %		

Due to the PWM control of the electronics the power supply unit is loaded with short, high current pulses. For this reason the supply voltage must be blocked or filtered by means of a capacitor (low ESR type, suitable type for high frequencies, high current switching, > 1000 µF) for noise suppression. Usually this capacitor is part of the power supply unit. Switch-mode power supplies, however, are often provided with a capacitor of only very small capacitance at the output so that this kind of pulses result in interference. In this case an additional capacitor must be connected as close to the motor as possible.

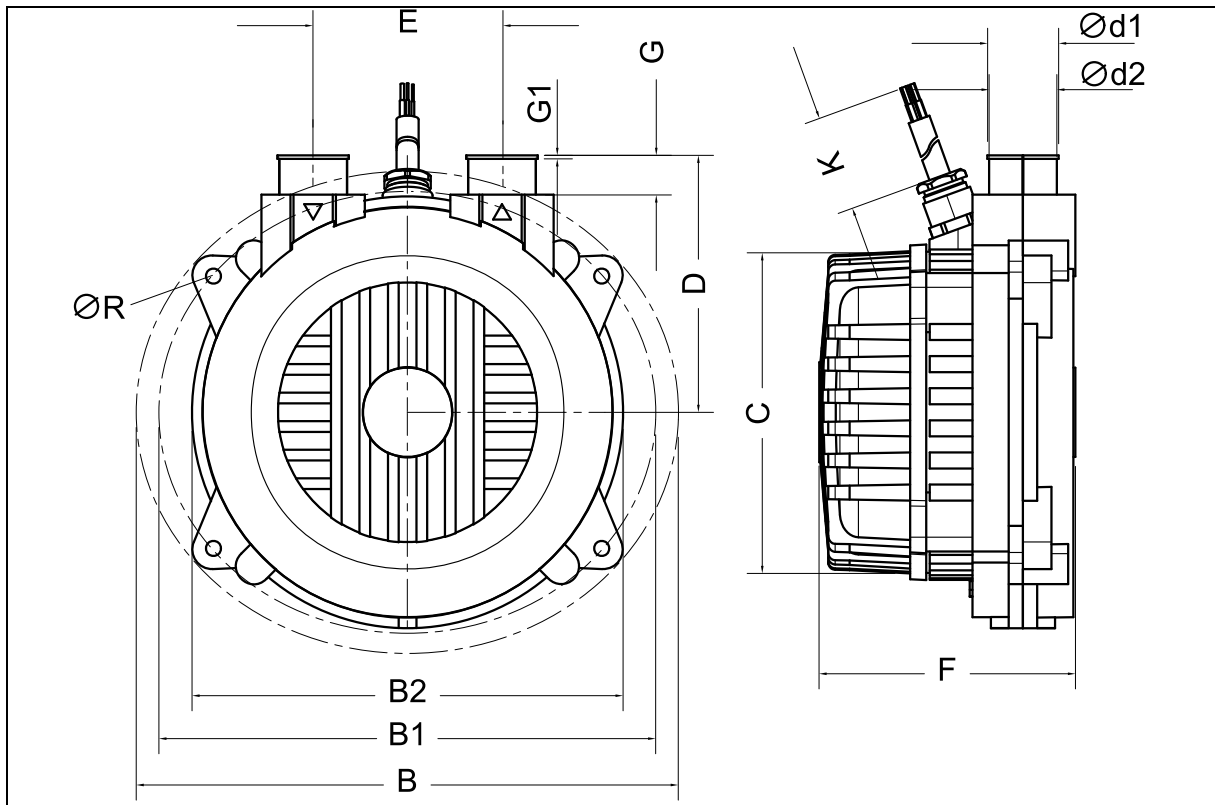

Fig. 1: Dimensions of the 2BH1002-0.... (hose connection)

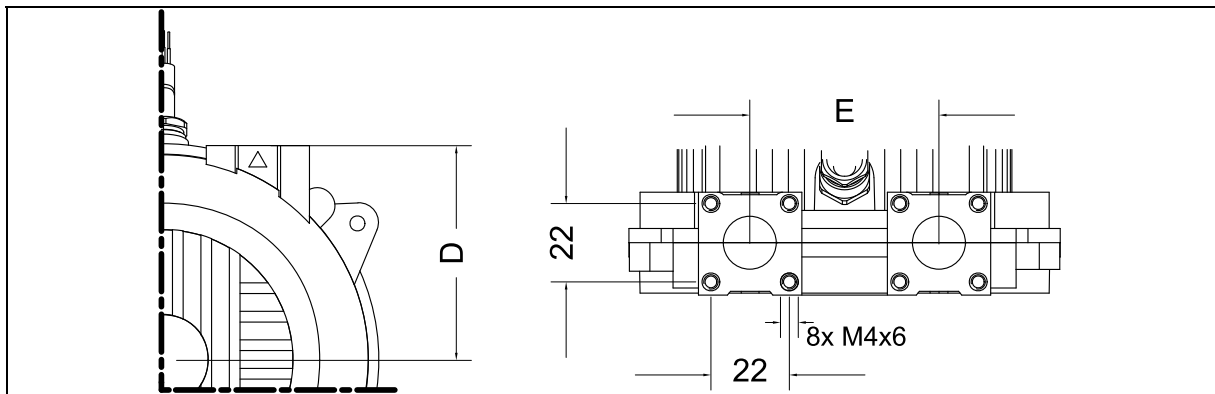

Fig. 2: Dimensions of the 2BH1002-1.... (flange connection)

Hose connection	B	B <sub>1</sub>	B <sub>2</sub>	C	D	Ø d <sub>1</sub>	Ø d <sub>2</sub>	E	F	G	G <sub>1</sub>	K	Ø R <sub>2</sub>
2BH1002-0AB32	145	133	121	95	72	20	19	53	72	11	1	450	4.2
2BH1002-0AB22	145	133	121	95	72	20	19	53	72	11	1	450	4.2
2BH1002-0AA53	145	133	121	95	72	20	19	53	92	11	1	450	4.2
Flange connection													
2BH1002-1AB32	145	133	121	95	60	20	19	53	72	11	1	450	4.2
2BH1002-1AB22	145	133	121	95	60	20	19	53	72	11	1	450	4.2
2BH1002-1AA53	145	133	121	95	60	20	19	53	92	11	1	450	4.2



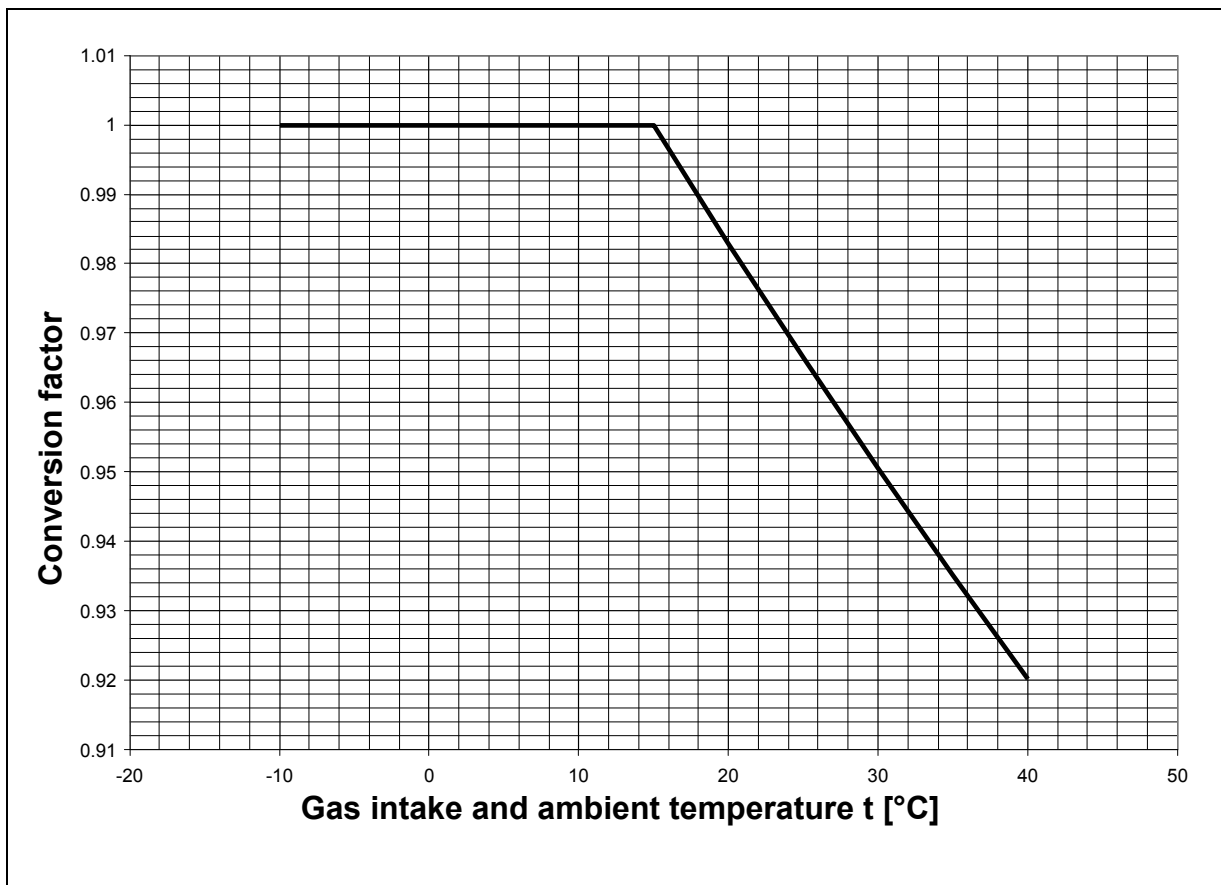

Fig. 3: Permissible total differential pressure / conversion factor

For the permissible total differential pressure at an intake and ambient temperature of +15°C [+59°F] see the table in section 3.1, "Nominal and Limiting Values Pump", page 6.

In order to calculate the permissible total differential pressure for other intake and ambient temperatures proceed as follows:

- Find out your **system-dependent gas intake and ambient temperature**.
- Establish the **conversion factor** valid for these conditions by means of the above diagram. (In order to do so mark your intake and ambient air temperature on the temperature axis. Draw a vertical line from this value to the point of intersection with the curve. Now draw a vertical line from the point of intersection to the conversion-factor axis where you can read the conversion factor then.)
- **Multiply** the established conversion factor with the max. permissible total differential pressure at 15°C as given in the table in section 3.1, "Nominal and Limiting Values Pump", page 6.
- The result will be a pressure value. This is the **max. permissible total differential pressure** valid for your G-BH100 at your system-dependent intake and ambient temperature.

## 4 Transport and Handling

### Packaging:

On delivery the G-BH100 is packed up in a cardboard box. When there is no connector attached to the electrical connecting cable the lead ends are surrounded by an ESD-prevention bag.



### IMPORTANT!

The motor of the G-BH100 including its connecting leads must be protected against electrostatic discharge (ESD).

Do not remove the ESD-prevention bag surrounding the lead ends until right before carrying out the electrical connection (attaching the connector, connecting to a terminal strip, or the like)!

## 5 Installation and Commissioning

### 5.1 Mounting

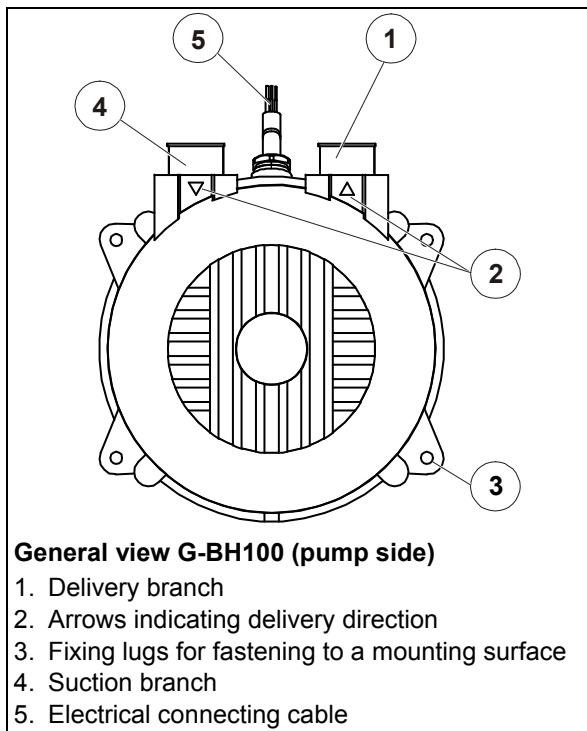

Fig. 4: General view G-BH100

For the arrangement of the G-BH100 and its components see

- Fig. 4: .

For the space required and the arrangement of the mounting holes required for fastening the G-BH100 to the mounting surface please refer to

- Fig. 1: , page 8,

The G-BH100 must be mounted as follows:

- the shaft being in any position,
- such as not to exceed the vibration values given in section 3, "Technical Data",
- for heat dissipation and cooling provide a **minimum distance of 15 mm** on each side except for the pump lid side on which a smaller distance of **at least 2 mm** is permissible (in case of mounting using rubber / metal elements, see page 10).

	<b>CAUTION!</b> Choose the place of installation / the mounting surface of the G-BH100 so that there is no hazard of tripping or bumping!
	<b>IMPORTANT!</b> Do not install the G-BH100 close to heating surfaces! No direct insulation!
	<b>CAUTION!</b> Lay the electrical connecting cable so that it might not be damaged by outer influences and is free from tensile stress!

#### Sound and vibration attenuation:

- In order to reduce sound emission fasten the G-BH100 only to parts or components **that do not conduct or emit sound easily** (e.g. thin walls, plates).
- Provide **sound-absorbing shims**, termed **rubber / metal elements** (available as accessories). These are rubber pads placed between the four fixing lugs and the mounting surface and used to absorb vibrations.





	<b>IMPORTANT!</b> During operation the surface of the G-BH100 might have high temperatures of more than 100°C! Temperature-sensitive parts or components, e.g. electrical wires or cables or electronic components must not be in contact with or fastened to these surfaces!
	<b>CAUTION!</b> Burning and scalding hazard due to hot surfaces of the G-BH100 during operation! Provide a guard against accidental contact.

Place the rubber / metal elements (rubber pads) between the fixing lugs (Fig. 4, # 6) and the mounting surface.

Fasten the G-BH100 to the mounting surface via the fixing lugs using four suitable bolts or nuts. Property class of the bolts or nuts: 8.8 according to ISO 898. Secure the four fixing bolts against unintentional loosening due to vibrations.

## 5.2 Connection

### 5.2.1 Electrical Connection (Motor)

	<p><b>WARNING!</b> Work on electrical installations may be carried out by trained and authorised electricians only!</p>
	<p><b>WARNING!</b> Before beginning any electrical work on the G-BH100 or the system carry out the following steps for both the G-BH100 and the entire system</p> <ul style="list-style-type: none"> <li>- switch off electricity,</li> <li>- lock against restart,</li> <li>- ensure absence of electricity,</li> <li>- ground and short-circuit installation,</li> <li>- cover or bar adjacent live parts.</li> </ul>
	<p><b>WARNING!</b> The connecting terminals</p> <ul style="list-style-type: none"> <li>- must be installed such that they cannot be touched during operation!</li> <li>- must be surrounded by a housing which is proof against foreign bodies, humidity, etc.! Consider the life expectancy of the seals and gaskets!</li> <li>- must be separated by sufficient distances (mind protruding wire ends)!</li> </ul>
	<p><b>WARNING!</b> Ensure that no foreign bodies, humidity, etc. enter the motor interior!</p>

The G-BH100 is operated using an electronics for speed and direction of rotation control. Depending on where this electronics is located (inside or outside the G-BH100), two types of the G-BH100 are distinguished





- **for external electronics** (see section 5.2.1.1, page 11):
  - 2BH10 02-0AA53
- **for integrated electronics** (see section 5.2.1.2, page 15):
  - 2BH10 02-0AB32
  - 2BH10 02-0AB22

In order to determine the type of your G-BH100 refer to the type number (MLFB) on the rating plate.

	<p><b>IMPORTANT!</b> The motor of the G-BH100 including its connecting leads must be protected against electrostatic discharge (ESD). Do not remove the ESD-prevention bag surrounding the lead ends until right before carrying out the electrical connection (attaching the connector, connecting to a terminal strip, or the like)! Carry out the electrical connection using the appropriate ESD-prevention equipment!</p>
---	--

#### 5.2.1.1 G-BH100 for external electronics

With this type the electronics is located outside the G-BH100. It is connected via the electrical connecting cable.

	<p><b>IMPORTANT!</b> The <b>main or operating direction of rotation</b> of the G-BH100 is the <b>counter-clockwise rotation</b>, given by the arrow indicating the direction of rotation on the pump lid (see Fig. 4, # 5, page 10). Only with the counter-clockwise rotation the nominal values will be achieved. Clockwise rotation is only permissible in special cases. In this instance the G-BH100 will not achieve its full output.</p>
	<p><b>IMPORTANT!</b> The connecting cable between the G-BH100 and the external electronics must have a length of <b>at maximum 0.5 m!</b></p>
	<p><b>IMPORTANT!</b> When switching off the G-Bh100 or rapidly reducing its speed a current feed into the mains might occur. This can be prevented by inserting a diode (Schottky diode, size 10A) in the 48-V supply lead (+U<sub>B</sub>)</p>
	<p><b>IMPORTANT!</b> Provide good cooling of the surroundings of the motor and the external electronics (e.g. mounting on a good thermal conductor, sufficient ventilation)! In case of temperatures of &gt; 50°C, measured at the surface of the external electronics (Drivecontrol VT-D), the output power of the pump might be reduced.</p>

**Purchasing the external electronics (Drive-control VT-D) along with the G-BH100**

For the order no. of this option please refer to our catalogue.

The design of the external electronics (Drivecontrol) is as follows:

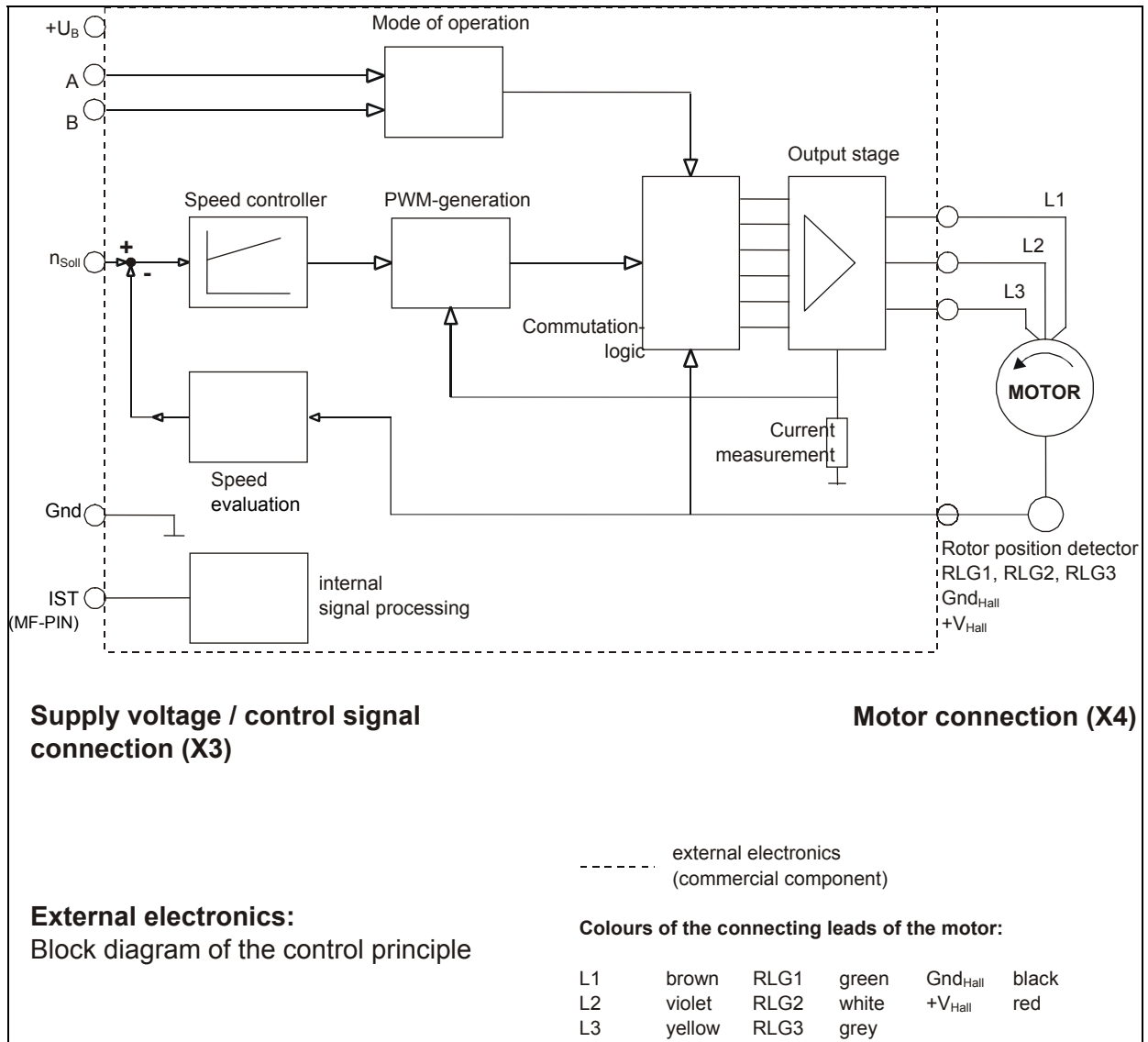

Fig. 5: External electronics: block diagram of the control principle

**Supply voltage/ control signal connection side:**

The connector for supply voltage / control signal connection (connector X3) is shown in Fig. 7, page 14.

On the supply voltage / control signal connection side the assignment is as follows:

Symbol	Description		Lead colour	Pin
A	Mode of operation	States: 1 (High): 5...24 V 0 (Low): < 0.5 V	white	Pin 1
+U <sub>B</sub>	+ Operating voltage	38 ... 52 V	red	Pin 2
-	Not used		violet	Pin 3
n <sub>Soll</sub> (S <sub>+</sub> )	Speed reference value	Control voltage: 0...10 V Reference value of the desired speed of the G-BH100.	green	Pin 4
B	Mode of operation	States: 1 (High): 5...24 V 0 (Low): < 0.5 V	grey	Pin 5
IST	Actual speed (optional)	Open Collector output Here the rotor speed can be read	yellow	Pin 6
Gnd	- Operating voltage	0 V	black	Pin 7
S <sub>-</sub>	Ground Set Value input	0 V	brown	Pin 8

Via the digital control inputs A and B the direction/mode of operation is determined.

The following states are possible:

Level A	Level B	Mode of operation
0	0	Output stage disabled (no current).
0	1	Counter-clockwise rotation (according to the arrow indicating the direction of rotation on the pump lid): <b>Main / operating direction of rotation of the G-BH100!</b>
1	0	Clockwise rotation (opposed to the arrow indicating the direction of rotation on the pump lid):
1	1	Breaking

Please take also note of the following data:

Wire cross section of the connecting cable      0.5 mm<sup>2</sup>

Control current on the supply voltage /  
control signal connection side                      max. 9 A

**Motor connection side:**

The connector for motor connection (connector X4) is shown in Fig. 7, page 14.

On the motor connection side the assignment is as follows:

Symbol	Description		Lead colour	Pin
L1	Motor phase 1	Terminals of the motor windings. Operating voltage: 48 V against electronics max. winding peak current: 13 A max. winding temperature: 115°C	brown	Pin 6
L2	Motor phase 2		violet	Pin 5
L3	Motor phase 3		yellow	Pin 1
RPD1	Hall signal 1	Rotor position detectors. Hall ICs with open collector output. They must be wired to an external pull-up resistor.	green	Pin 4
RPD2	Hall signal 2		white	Pin 3
RPD3	Hall signal 3		grey	Pin 8
+V <sub>Hall</sub>	Hall supply	Feeder line of the hall ICs.	red	Pin 2
Gnd <sub>Hall</sub>	Hall supply		black	Pin 7

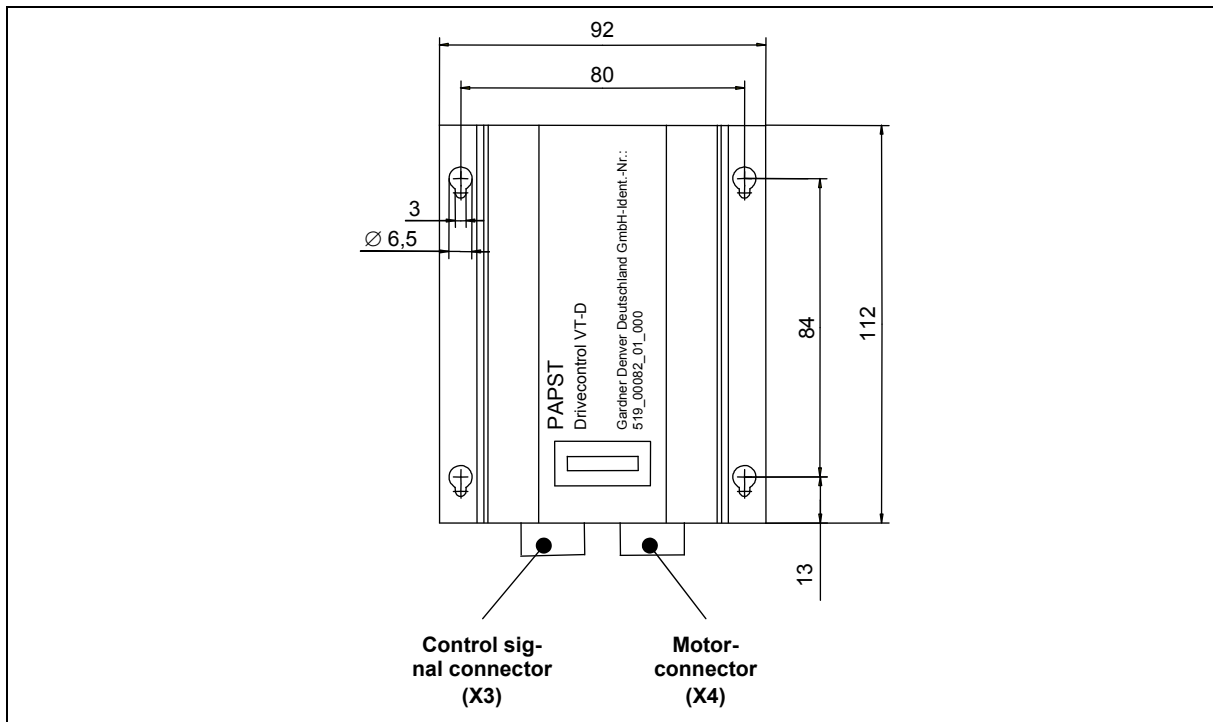

Fig. 6: External electronics

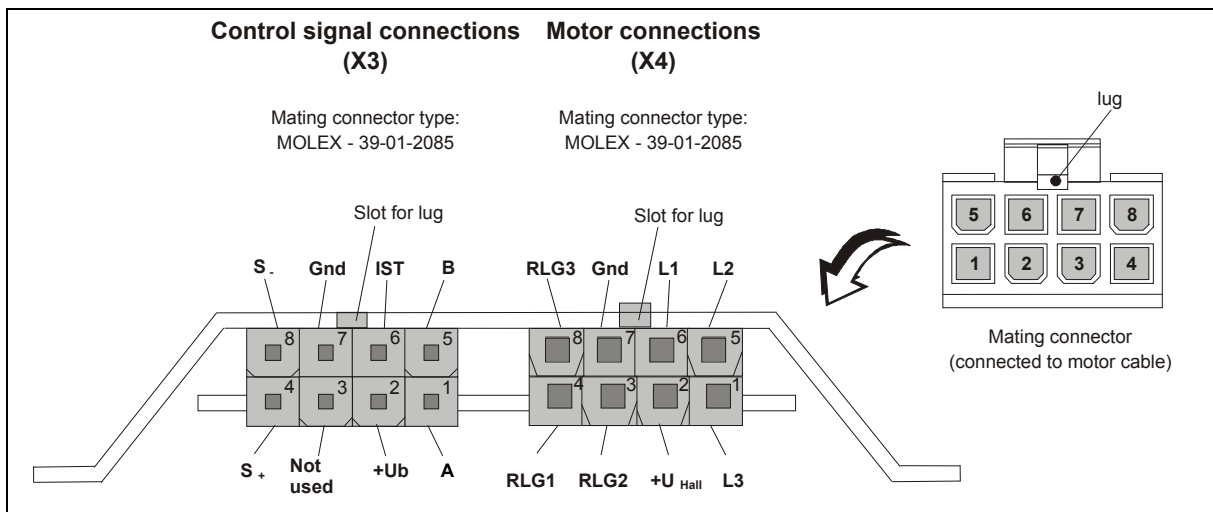

Fig. 7: Connector pin assignment and mating connector

If there is no connector (mating connector to the external electronics) connected to the motor cable of the G-BH100, the loose lead ends are surrounded by an ESD-prevention bag. In this case, the socket connector must first be connected to the motor cable.



**IMPORTANT!**

The motor of the G-BH100 including its connecting leads must be protected against electrostatic discharge (ESD).

Do not remove the ESD-prevention bag surrounding the lead ends until right before carrying out the electrical connection (attaching the connector, connecting to a terminal strip, or the like)!

Carry out the electrical connection using the appropriate ESD-prevention equipment!

The scope of supply of the external electronics (Drivecontrol VT-D) includes a connector with a 300 mm wiring harness to connect the Drivecontrol to the supply voltage and control voltage.

In order to meet the requirements bearing on **electromagnetic compatibility** a suitable EMI filter (e.g. CORCOM, Type 6ET1, 10A) must be connected in series with the external-electronics. The connecting cable between the EMI filter and the G-BH100 must have a length of **at maximum 0,3 m**.

**5.2.1.2 G-BH100 with integrated electronics**

With this type the electronics is located inside the motor.

	<p><b>IMPORTANT!</b> With the integrated-electronics type G-BH100 the electronics is particularly sensitive to overheating! It is imperative to ensure sufficient heat dissipation and cooling!</p>
---	---

On delivery the integrated-electronics type G-BH100 is not equipped with a connector at the connecting cable. In this instance the operator can, according to the requirements of the system, connect a connector at his option, connect the terminals to a terminal strip, etc.

The electrical connection is to be carried out:

- according to the applicable national and local laws and prescriptions
- according to the applicable system-dependent prescriptions and requirements
- according to the applicable prescriptions of the utility company

Via the motor connecting cable the supply voltage as well as the different control signals are applied to the integrated electronics.

For the assignment of the leads or strands please refer to Fig. 8 as well as the following table.





	Lead colour		Assignment
	Cable old version	Cable new version	
	pink	red	+V <sub>cc</sub>
	yellow	black	Gnd
	green	green	n <sub>des</sub>
	white	white	A
	grey	grey	B
	blue	blue	n <sub>lst</sub>
	brown	--	not connected
	red	--	not connected

Fig. 8: Connection of the integrated electronics type

Symbol	Description	Level	Lead colour	
			Cable old version	Cable new version
<b>+U<sub>B</sub></b>	DC operating voltage	24 V (max. 28 V)	<b>pink</b>	<b>red</b>
<b>Gnd</b>	DC operating voltage, reference potential for all signals	0 V	<b>yellow</b>	<b>black</b>
n <sub>des</sub>	Speed reference value: Reference value of the desired speed of the G-BH100.	0 ... 10 V DC	green	green
n <sub>act</sub>	Frequency output representing the actual speed: open collector signal which must be wired to an external pull-up resistor. Output frequency / motor speed ratio: 1 Hz = 10 min <sup>-1</sup>	Open collector max. 24 V / 10 mA	blue	blue
A	Control signals A and B are digital inputs. Broad voltage-range input compatible with TTL / PLC signals. In all four possible combinations:  <b>A B Function</b> 0 0 Motor disabled (no current) 0 1 CCW rotation 1 0 CW rotation 1 1 Motor disabled	Low (0): < 0.5 V DC High (1): > 4 V DC max. 30 V DC	white	white
B			grey	grey
--	not connected	--	brown	--
--	not connected	--	red	--

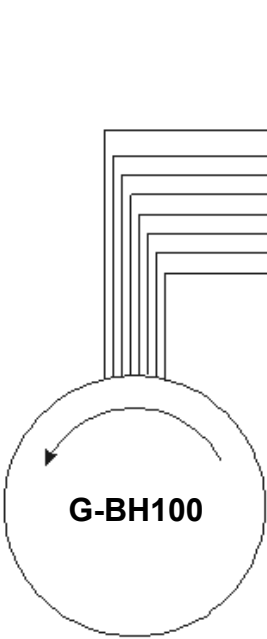
In order to meet the requirements bearing on **electromagnetic compatibility** an EMI filter from Messrs CORCOM, Type 6ETI F7003, 6A, must be connected in series with the integrated-electronics type G-BH100. The connecting cable between the EMI filter and the G-BH100 must have a length of **at maximum 0.5 m**.

	<p><b>IMPORTANT!</b> When switching off the G-BH100 or rapidly reducing its speed a current feed into the mains might occur. This can be prevented by inserting a diode (Schottky diode, size 6A) in the 24-V supply lead (+U<sub>B</sub>).</p>
---	---

	<p><b>IMPORTANT!</b> The <b>main or operating direction of rotation</b> of the G-BH100 is the <b>counter-clockwise rotation</b>, given by the arrow indicating the direction of rotation on the pump lid. Only with the counter-clockwise rotation the nominal values will be achieved. Clockwise rotation is only permissible in special cases. In this instance the G-BH100 will not achieve its full output.</p>
	<p><b>IMPORTANT!</b> The connecting cable between the G-BH100 and the external electronics must have a length of <b>at maximum 0.5 m!</b></p>



### 5.2.2 Pipe/ hose connections (pump)

On delivery the suction and delivery branches of the G-BH100 are sealed up in order to prevent foreign bodies from entering the pump.

Do not remove the seals until right before connecting the pipes/ hoses.

	<b>IMPORTANT!</b> The G-BH100 must not be operated with the suction or delivery branches sealed up or jammed!
---	--

For the arrangement of the branches see Fig. 4, page 10.

The operating direction of the G-BH100 is indicated by means of arrows:

- The direction of rotation is indicated by an arrow on the pump casing.
- The delivery direction is indicated by arrows on the suction and delivery branches.

	<b>IMPORTANT!</b> The main or operating direction of rotation of the G-BH100 is the counter-clockwise rotation, given by the arrow indicating the direction of rotation on the pump lid. Only with the counter-clockwise rotation the nominal values will be achieved. Clockwise rotation is only permissible in special cases. In this instance the G-BH100 will not achieve its full output.
---	---





The pumped gases / vapours are taken in via the suction branch and are expelled via the delivery branch.

The **suction branch** (see Fig. 4 # 4, page 10) is indicated by an arrow pointing into the pump. Connect the suction pipe to this branch.





The **delivery branch** (see Fig. 4 # 1, page 10) is indicated by an arrow pointing out of the pump. Connect the delivery pipe to this branch.

	<b>IMPORTANT!</b> These instructions apply to the counter-clockwise rotation! In case of clockwise rotation the suction and delivery branches are exchanged!
---	--

Make sure to connect the pipes / hoses so that the G-BH100 will not be subject to any stress or strain.

	<b>WARNING!</b> Rotating impeller - hazard of severing limbs! In case of operation with open suction or delivery branches (drawing-in of gases from or discharge of gases into the surroundings) a piece of pipe or hose <b>with a length of at least 120 mm</b> must <b>by all means</b> be connected to the branch in question in order to prevent the impeller from being reached by fingers!
	<b>IMPORTANT!</b> The pipes/ hoses must be attached in a secure and tight fashion. They must be locked against unintentional loosening e.g. due to vibrations, thermal expansion, etc.
	<b>WARNING!</b> Check pipes/ hoses and vessels for sufficient strength!
	<b>WARNING!</b> Check pipe/ hose connections for tightness!
	<b>IMPORTANT!</b> Provide a shut-off device and / or a means for depressurisation in both the suction and the delivery pipes.

### 5.3 Commissioning





	<p><b>WARNING!</b> Operation of the G-BH100 only:</p> <ul style="list-style-type: none"> <li>• with the pump lid assembled</li> <li>• with the pipes/ hoses connected to the suction and delivery branches or</li> <li>• in case of operation with open suction or delivery branches (drawing-in of gases from or discharge of gases into the surroundings)</li> <li>• with a piece of pipe or hose <b>having a length of at least 120 mm</b> connected to the branch in question</li> <li>• with bearing end housing</li> </ul>
	<p><b>WARNING!</b> Do not reach into the G-BH100 through open suction or delivery branches! Do not insert any objects into the G-BH100 through the openings!</p>
	<p><b>IMPORTANT!</b> The G-BH100 must not be operated with the suction or delivery branches sealed up or jammed!</p>
	<p><b>WARNING!</b> Before start-up</p> <ul style="list-style-type: none"> <li>• check pipes / hoses and vessels for sufficient strength!</li> <li>• check pipe / hose connections for tightness!</li> <li>• check fasteners for secure fixing</li> </ul>

- speed reference and applied to  $n_{des}$  (0 to 10 V) to your desired value or the value given on the data sheet. By means of this speed control the operating point of the G-BH100 is adapted to the operating point of the system.
- Check the connections for tightness (ensure that there is no fluid leakage).

Proceed as follows:

- Make sure
  - that the suction and delivery pipes are correctly connected,
  - that in case of operation with open suction or delivery branches (drawing-in of gases from or discharge of gases into the surroundings) a piece of pipe or hose **having a length of at least 120 mm** is connected to the branch in question in order to prevent the impeller from being reached by fingers.
  - that the suction and delivery pipes are not jammed,
  - that all fasteners are properly tightened,
  - that the correct voltage and current are applied.
- Set the control voltage serving as speed reference and applied to  $n_{des}$  to 0 V at first.
- Turn on the indicated operating voltage. Now increase the control voltage serving as

## 6 Operation







	<p><b>WARNING!</b> Operation of the G-BH100 only:</p> <ul style="list-style-type: none"> <li>• with the pump lid assembled</li> <li>• with the pipes / hoses connected to the suction and delivery branches or in case of operation with open suction or delivery branches (drawing-in of gases from or discharge of gases into the surroundings) with a piece of pipe or hose <b>having a length of at least 120 mm</b> connected to the branch in question</li> <li>• with the bearing end housing</li> </ul>
	<p><b>IMPORTANT!</b> The G-BH100 must not be operated with the suction or delivery branches sealed up or jammed!</p>
	<p><b>CAUTION!</b> Burning and scalding hazard due to hot surfaces of the G-BH100! Do not touch during operation!</p>
	<p><b>WARNING!</b> Before start-up and at regular intervals</p> <ul style="list-style-type: none"> <li>• check pipes / hoses and vessels for sufficient strength!</li> <li>• check pipe / hose connections for tightness!</li> <li>• check fasteners for secure fixing</li> </ul>

### Speed control:

During operation the speed of the G-BH100 can be modified. This allows to adapt the operating point of the G-BH100 to changes in the operating point of the system.

In order to do so adjust the control voltage applied to  $n_{des}$  within a range of 0 to 10 V.

## 7 Servicing

	<p><b>WARNING!</b></p> <p>Before beginning to work on the G-BH100 or the system carry out the following steps for both the G-BH100 and the entire system</p> <ul style="list-style-type: none"> <li>• switch off electricity,</li> <li>• lock against restart,</li> <li>• ensure absence of electricity,</li> <li>• ground and short-circuit installation,</li> <li>• cover or bar adjacent live parts,</li> <li>• depressurise both pipes and pump.</li> </ul>
	<p><b>WARNING!</b></p> <p>Disassembly of</p> <ul style="list-style-type: none"> <li>• the pump lid</li> <li>• the pipe / hose connections</li> <li>• the guard in front of the motor only after the impeller and the rotor have come to a complete standstill!</li> </ul> <p>Consider run-out! Disassembly of the bearing end housing is prohibited!</p>
	<p><b>CAUTION!</b></p> <p>Burning and scalding hazard due to hot surfaces of the G-BH100! Let the unit cool after shut-down!</p>
	<p><b>WARNING!</b></p> <p>Do not reach into the G-BH100 through open suction or delivery branches! Do not insert any objects into the G-BH100 through the openings!</p>
	<p><b>CAUTION!</b></p> <p>After loosening clampings and fastening elements some parts and components are only held in place by their centring or seatings or are no longer held in place at all so that they might fall down.</p>
	<p><b>WARNING!</b></p> <p>Before recommissioning</p> <ul style="list-style-type: none"> <li>• completely re-assemble the G-BH100</li> <li>• check if all fasteners have been re-assembled and tightened</li> <li>• check pipes / hoses and vessels for sufficient strength</li> <li>• check pipe / hose connections for tightness</li> </ul>

	<p><b>WARNING!</b></p> <p>Work on electrical installations may be carried out by trained and authorised electricians only!</p>
---	--

### 7.1 Maintenance

#### 7.1.1 Cleaning

##### Exterior:

- In case of lint or dust on the pump: Clean the entire surface of the G-BH100 wiping it with a wet cloth.

##### Interior:

- See also Fig. 9, page 21
- Disassemble pump lid (# 3).  
In order to do so loosen the four bolts (# 1) and carefully pull off the lid in axial direction (see arrow) so that the pin is not bent.

	<p><b>IMPORTANT!</b></p> <p><b>Don not detach the impeller nut (# 4)!</b> Do not disassemble the impeller (# 4)!</p> <p>Otherwise, inside the motor the rotor would be displaced by a spring resulting in the G-BH100 having to be completely disassembled and re-assembled!</p>
--	--

- Remove lint using e.g. a pair of tweezers.

	<p><b>IMPORTANT!</b></p> <p>Do not use compressed air in order to clean the pump interior since this might result in dirt entering the motor interior.</p>
---	--

- Re-assemble pump lid (# 3).  
In order to do so carefully set the lid to the pump so that the pin is inserted in the hole and thus the lid is aligned. Carefully place the lid on the pump in axial direction (see arrow) so that the pin is not bent.
- Screw in the bolts (# 1) securing them using **Loctite 243**.  
Fastening torque of the bolts:  
 $T_f = 2 \text{ Nm} \pm 0.2$

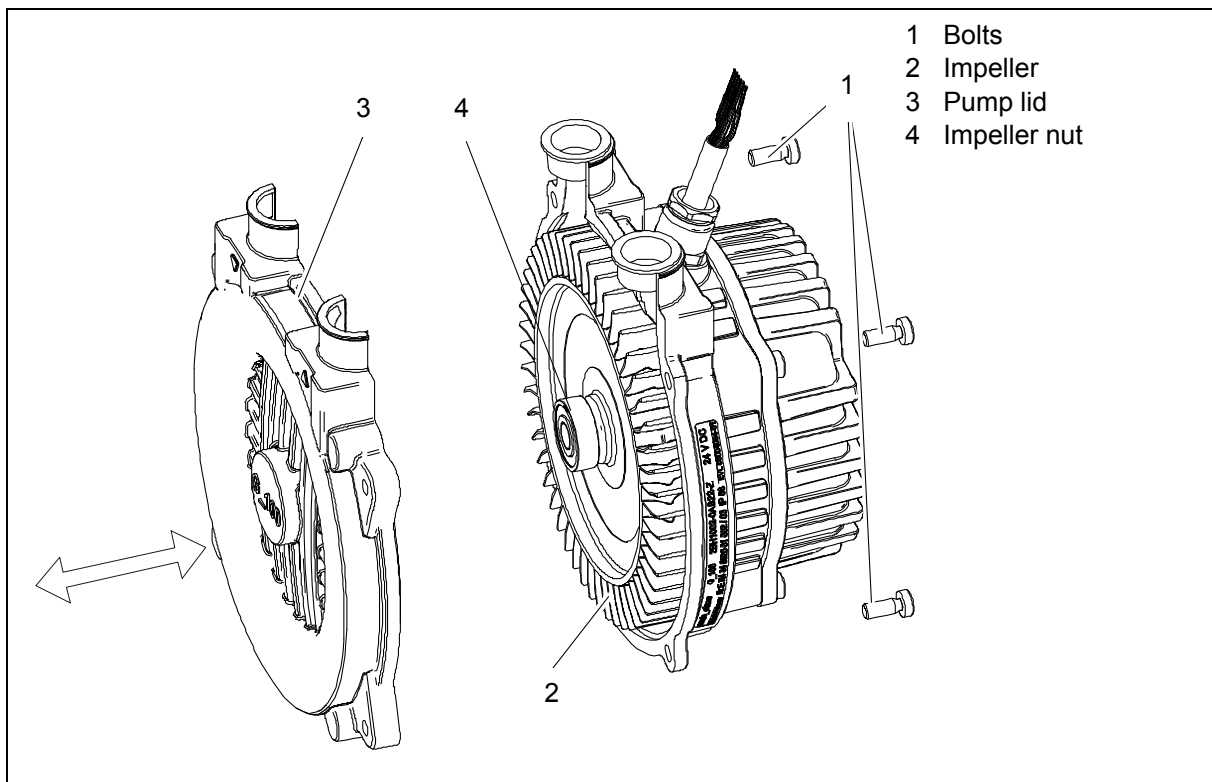

Fig. 9: Disassembly/ assembly of the pump lid

### 7.1.2 Inspection

Carry out the following tasks on the G-BH100 at regular intervals:

- Fastening to the mounting surface:  
Tighten fixing bolts.  
Fastening torque: according to property class 8.8 of the bolts or nuts used as given in ISO 898
- Cable entry:  
Tighten screwed cable glands.  
Fastening torques:
  - on casing side:  $T_f = 3.2 \text{ Nm} \pm 0.2$
  - on cable side:  $T_f = 1.5 \text{ Nm} \pm 0.2$
- Suction and delivery branches:  
Check pipe / hose connections for secure fixing and tightness.  
Check pipes / hoses for tightness.  
Consider material fatigue!  
Replace worn parts.

### 7.1.3 Lubrication



#### **IMPORTANT!**

The bearings of the G-BH100 are provided with a lifetime lubrication and assembled in the pump by adhesive bonding.

## 7.2 Repair/ Troubleshooting

Fault	Cause	Remedy	Carried out by
Motor does not start, no motor noise.	At least two power supply leads interrupted.	Check fuses, terminals and supply leads and close circuit where interrupted.	Electrician
	No signal at control signal inputs A and B.	Apply control signals, see section 5.2.1, "Electrical Connection (Motor)", page 11.	Electrician
	No speed reference value given.	Set speed reference value, see section 5.2.1, "Electrical Connection (Motor)", page 11.	Electrician
Motor does not start, humming noise.	Impeller jammed.	Open pump lid, remove dirt and foreign bodies, as described in section 7.1.1, "Cleaning", page 20.	Qualified personnel
	Impeller damaged.	Replace impeller.	Service
	Motor bearing damaged.	Replace "complete casing" (i.e. the unit consisting of casing, stator and two ball bearings).	Service
	Wrong connection of motor connecting leads.	Check and, if necessary, correct the connection of the motor phases and hall signals to the drive electronics, see section 5.2.1, "Electrical Connection (Motor)", page 11.	Electrician
Power consumption too high.	Winding short-circuit.	Have winding checked.	Electrician
	Motor overload.	Reduce operating pressure. If necessary, clean filter, silencers, and pipes.	Qualified personnel
	Impeller jammed.	See "Motor does not start, humming noise".	Qualified personnel
No vacuum / pressure or too little vacuum / pressure generated.	Leak in the system.	Seal leak in the system.	Qualified personnel
	Wrong direction of rotation.	Reverse direction of rotation by applying the correct signals to the control signal inputs A and B see section 5.2.1, "Electrical Connection (Motor)", page 11.	Electrician
	Speed reference value representing the desired speed ( $n_{des}$ ) too low.	Adjust speed reference value ( $n_{des}$ ) within a range of 0...10 V.	Qualified personnel
	Temperature of the electronics too high.	Provide sufficient heat dissipation and cooling.	Qualified personnel
	Blower too small.	Use bigger blower.	Operator / qualified personnel
	Density of the pumped gas unequal 1.23 g/m <sup>3</sup> (= density of air at 15°C [59°F] and 1013 mbar).	Use bigger blower.	Operator / qualified personnel
	Impeller dirty.	Clean impeller; if worn, have impeller replaced.	Qualified personnel / Service
Abnormal screeching noise.	Flow rate too high.	Increase pipe cross section, clean pipe.	Qualified personnel
	Ball bearing damaged.	Replace "complete casing" (i.e. the unit consisting of casing, stator and two ball bearings).	Service
Impeller leak.	Relative pressure between blower and surroundings too high.	The permissible differential pressure between the pump interior and the surroundings has been exceeded. Make sure that the differential pressure is not exceeded.	Qualified personnel
Current feed to the mains.	Caused by switching off or rapidly reducing the speed of the blower.	Insert a diode (Schottky diode, size 6A respectively 10A) in the 24V respectively 48V supply lead (+V <sub>CC</sub> ).	Electrician

## 8 Shutting Down and Measures for Prolonged Standstill

	<p><b>IMPORTANT!</b> If the storage period exceeds one year the life expectancy of the bearings might be reduced.</p>
---	---

### Measures after shutdown / before storage:

- Seal up the suction and delivery branches.
- Provide loose lead ends with an ESD-prevention bag.
- Ensure the correct storage conditions (see below).

### Storage conditions:

Ambient temperature	-20°C...+70°C (-4°F...+158°F)
Relative humidity	10% ... 95%
Atmospheric pressure	500 hPa ... 1,100 hPa
Vibrations	see section 3, "Technical Data", page 6.

### Measures before recommissioning after storage:

- Make sure that there is no oxide layer on the contacts. If necessary, remove oxide layer.
- Make sure that the insulation of the electrical connecting cable has not become porous.

## EU declaration of conformity

**Manufacturer:** Gardner Denver Deutschland GmbH  
P.O. Box 1510  
D-97605 Bad Neustadt / Saale

**Responsible for documentation:** Holger Krause  
P.O. Box 1510  
D-97605 Bad Neustadt / Saale

**Designation:** G series Side channel blower  
G-BH10  
Types 2BH10 02-.AB32  
2BH10 02-.AB22  
2BH10 02-.AA53

**The side channel blower described above meets the following applicable Community harmonisation legislation:**

**2004/108/EC<sup>\*)</sup>** Directive 2004/108/EC of the European Parliament and of the Council of 15 December 2004 on the approximation of the laws of the Member States relating to electromagnetic compatibility and repealing Directive 89/336/EEC

**2006/42/EC** Directive 2006/42/EC of the European Parliament and of the Council of 17 May 2006 on machinery, and amending Directive 95/16/EC

The protection targets of the directive 2006/95/EC have been met

### Harmonised standards applied:

**EN 1012-2:1996** Compressors and vacuum pumps — Safety requirements — Part 2: Vacuum pumps  
**+A1:2009**

### Other technical standards and specifications used:

**EN 1012-1:1996** Compressors and vacuum pumps — Safety requirements — Part 1: Compressors

Bad Neustadt/Saale, 23.04.2010

*(Place and date of issue)*

Thomas Kurth, Managing Director

*(Name and function)*



*(Signature)*

<sup>\*)</sup> applies only to 2BH10 02- \_AB32

664.44431.40.000



---

---

---

---

---



**Elmo  
Rietschle**  
*A Gardner Denver Product*

[www.gd-elmorietschle.de](http://www.gd-elmorietschle.de)  
[er.de@gardnerdenver.com](mailto:er.de@gardnerdenver.com)

**Gardner Denver  
Schopfheim GmbH**  
Roggenbachstraße 58  
79650 Schopfheim · Deutschland  
Tel. +49 7622 392-0  
Fax +49 7622 392-300

**Gardner Denver  
Deutschland GmbH**  
Industriestraße 26  
97616 Bad Neustadt · Deutschland  
Tel. +49 9771 6888-0  
Fax +49 9771 6888-4000

**Gardner  
Denver**

Elmo Rietschle is a brand of  
Gardner Denver's Industrial Products  
Group and part of Blower Operations.