

LOOK INSIDE FOR

**EVOLUTION**

OPTIMIZED PERFORMANCE

**SANDPIPER®**

A WARREN RUPP, INC. BRAND | [SANDPIPERPUMP.COM](http://SANDPIPERPUMP.COM)



**IPEX**

PRODUCT CATALOG



SANDPIPER®  
*Signature*  
SERIES

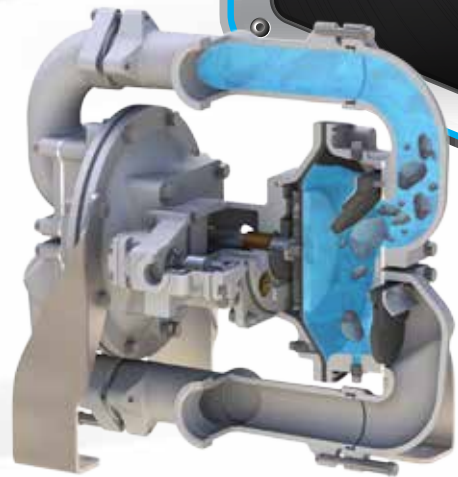

**Heavy Duty Flap Valve**

For fluids containing up to line size solids.



**Heavy Duty Ball Valve**

For fluids containing settling, suspended & floating solids.



**Containment Duty Ball Valve**

The only complete line of AODD pumps featuring superior fluid containment; protecting your people, environment and pump.

What is

**EVOLUTION**



OPTIMIZED PERFORMANCE

**Optimized performance** without sacrificing **proven reliability**. These pumps have undergone an engineering **EVOLUTION**, leveraging trusted and proven product designs to **improve their performance** by application of advanced engineering methods. Unlike the competition, these pumps are **fully interchangeable** with prior models.

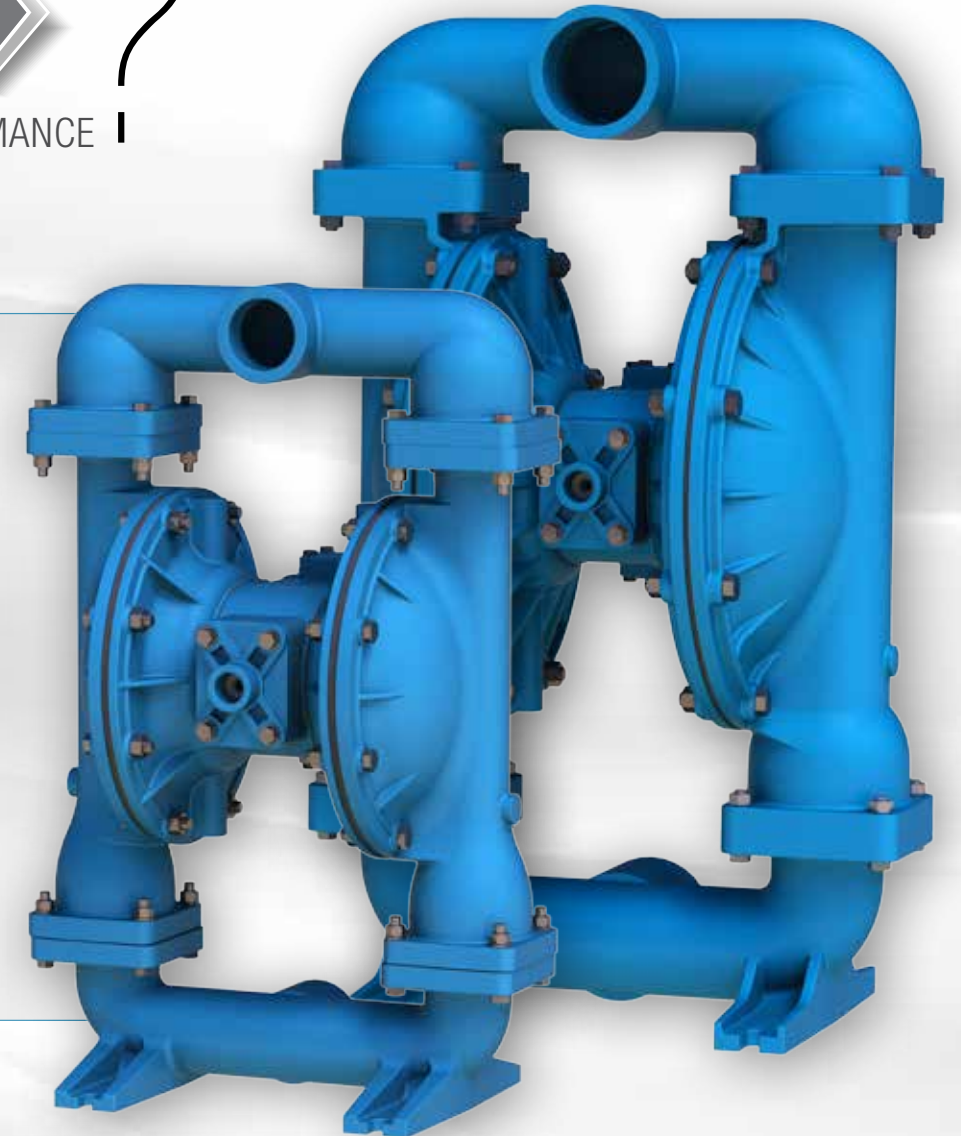

**OUR SIGNATURE ENSURES YOUR SUCCESS**

SANDPIPER Signature Series AODD pumps are engineered to deliver industry leading durability and performance, even for your most severe applications and environments.

LEARN MORE AT: [SANDPIPERPUMP.COM/SIGNATURE-SERIES](http://SANDPIPERPUMP.COM/SIGNATURE-SERIES)

**WHEREVER YOU SEE THIS BADGE:**

These pumps have gone through our Evolution performance improvement. Watch for more Engineering Evolutions to come in the near future!

LEARN MORE AT: [SANDPIPERPUMP.COM/EVOLUTION](http://SANDPIPERPUMP.COM/EVOLUTION)

# ENGINEERED PUMPING SOLUTIONS WITH MORE WAYS THAN ONE

For over 50 years, SANDPIPER, a Warren Rupp, Inc. brand, has been a leading global Air Operated Double Diaphragm (AODD) pump company, featuring the broadest range of products to meet the needs of a wide variety of applications. Decades of innovation, combined with world class engineering expertise, allows the SANDPIPER team to create products that meet the demand of an ever-changing marketplace.  
**LEARN MORE AT SANDPIPERPUMP.COM**



**Global Coverage**  
Contacts in 75 Countries and Over 1 Million Pumps Sold

**World Headquarters**  
800 N. Main Street  
Mansfield, Ohio 44902  
USA

**Pump Technology**  
Air Operated Double Diaphragm Pumps (AODD)

**Certified Quality**



**CE**  
Products are Declared Compliant to Directive 2006/42/EC - Machinery Safety



**ATEX**  
Products are Either EC-Type or Type Examination Certified to Directive 94/9/EC - Machinery for Use in Potentially Explosive Atmospheres



**EurAsian Conformity**  
Certified to sell products into Eurasian Economic Union



**CSA**  
G-Series Natural Gas Operated Pumps are CSA Certified to ANSI LC6:2008 and Canadian Technical Letter No. R-14



**ISO 9001 Quality**  
Quality System Certified to Ensure Every Product is Made with Care and Quality Control



**ABS Marine & Offshore**  
American Bureau of Shipping Type Approval of Metal SANDPIPER Pumps and Tranquillizer Surge Suppressors



**FDA**  
FDA Accepted Materials of Construction



**EC1935**  
Food Processing T-Series Model Plastic and Elastomer Food Contact Components Meet the Requirements of EU Regulation 1935/2004/EC



**Underwriters Laboratories**  
U1F Model Pumps are UL Listed to UL79 Standard for Use in Fuel Transfer and Pumping Flammable Fluids

## Table of Contents

Why Choose AODD Pumps .....	6	Heavy Duty Flap Valve Pumps .....	20
AODD Pump Operation .....	8	Heavy Duty Ball Valve Pumps .....	28
Installation Versatility .....	9	Containment Duty Ball Valve Pumps .....	32
The SANDPIPER Advantage .....	10	Standard Duty Ball Valve Pumps .....	36
Engineering Capabilities .....	12	Special Duty Pumps .....	44
Markets & Applications .....	14	Accessories .....	62
Pump Selection .....	16	Diaphragm Selection .....	68
Exclusive Pump Configurations .....	18	Genuine Parts Service Kits .....	70

# WHY CHOOSE AODD PUMPS

PERFORMING IN THE MOST CHALLENGING APPLICATIONS, AODD PUMPS DELIVER UNIQUE BENEFITS THAT ARE UNRIVALED BY OTHER PUMP TECHNOLOGIES

AODD pumps are air (or natural gas) operated displacement type pumps which uniquely differ from all other positive displacement pumps. As a result of air pressure acting on the entire surface of the diaphragm, the diaphragm is in a balanced condition while pumping. This measurably extends diaphragm life over that of mechanically operated diaphragm pumps. Because compressed air is limited, the maximum pressure developed by the pump is also safely limited. Thus, AODD pumps are appropriately selected for on-demand intermittent requirements.

## Unique Performance

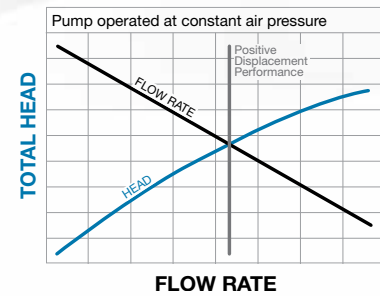

Although the AODD pump is a displacement type, it is actually a hybrid and defies strict classification. While its pressure versus capacity characteristics resemble those of a centrifugal pump, it is best defined as a sealless, non (or semi) positive displacement pump.



## Features & Benefits

-  Dry-run without damaging the pump or system
-  Pumps solid laden fluids without pump or product damage
-  Self-priming, works in suction lift applications
-  Deadheads safely, with no pump or product damage
-  Shear sensitive, does not shear or separate product being pumped
-  No electricity required, and can be fully grounded
-  Low initial purchase price compared to other technologies
-  Submersible, can be submerged completely without safety or performance issues
-  Sealless design, no expensive mechanical seals or packing are required
-  Variable flow and head pressures, without sophisticated controls
-  Optional bottom discharge porting depending on fluid characteristics

AODD VS. OTHERS	PUMPING PRINCIPLE						
	AODD	Kinetic Centrifugal	Positive Displacement				
		Centrifugal	Lobe	Gear	Progressive (Screw)	Peristaltic (Hose)	Piston/Plunger
Variable Flow & Head Control <i>(inherently adjustable)</i>	✓	✓	✓	✓	!	!	✓
Deadheads Safely <i>(at zero energy consumption)</i>	✓	!	!	!	!	!	!
Dry-Running	✓	X	X	X	X	X	X
Dry-Priming <i>(lift installations)</i>	✓	X	X	✓	X	X	!
No Installation Alignment Required	✓	X	X	X	X	X	X
No Electrical Installation Required	✓	X	X	X	X	X	X
Portability	✓	✓	!	!	!	✓	!
Submersible	✓	!	X	X	X	X	X
Sealless <i>(no packing or mechanical seals)</i>	✓	!	!	!	!	!	!
No Slip <i>(thin liquids)</i>	✓	✓	!	!	!	✓	!
Cavitation Tolerance <i>(low NPSHa)</i>	✓	X	!	!	✓	!	!
Low Shear & Degradation	✓	X	✓	✓	!	!	!

✓ = Suitable    ! = Limitations    X = Not Recommended

# OPERATION & INSTALLATION

FIXED, MOUNTED OR PORTABLE SANDPIPER PUMPS ARE DESIGNED TO PERFORM IN THE MOST DIFFICULT CONDITIONS

## AODD Pump Operation

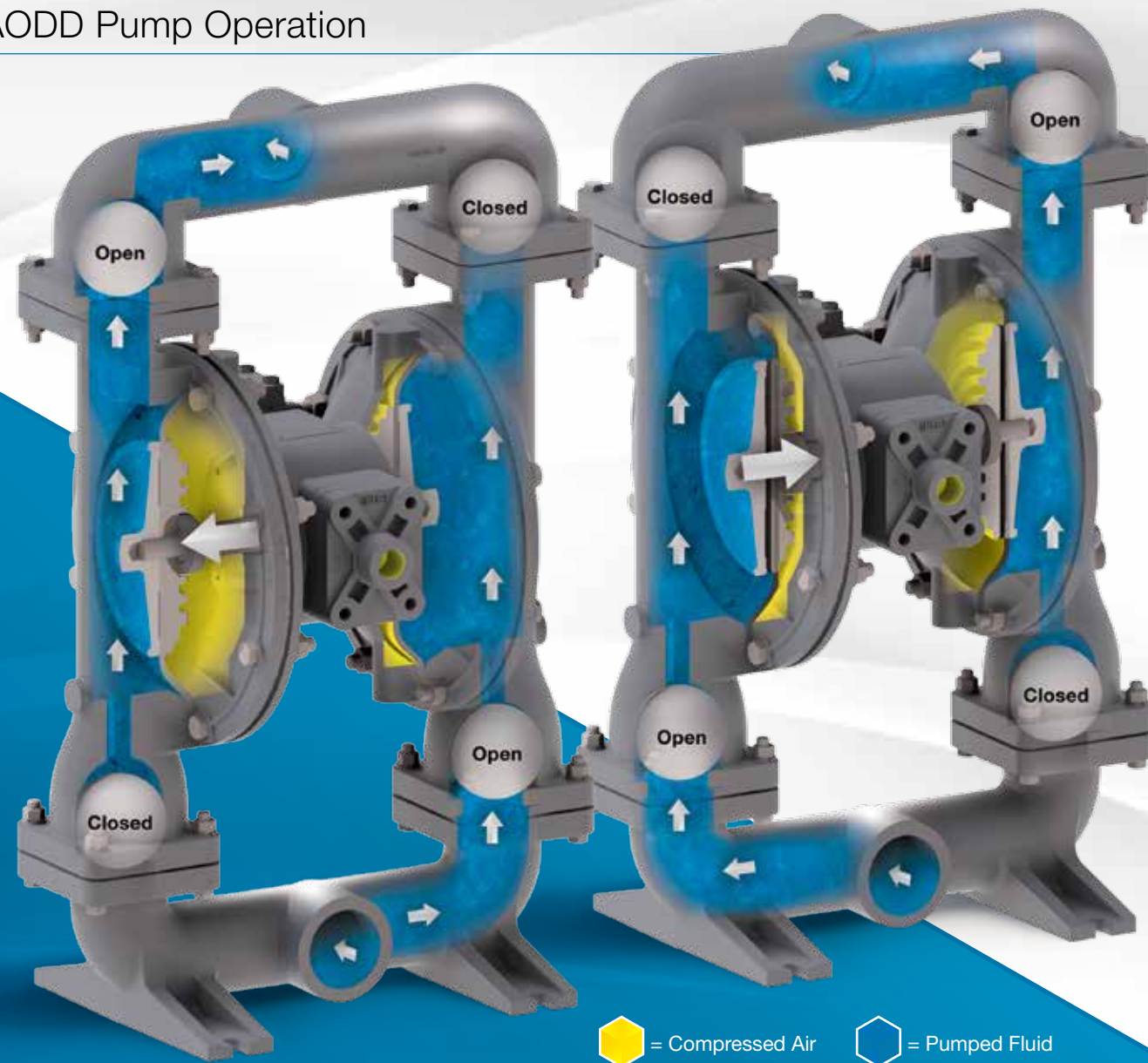

**1 Suction Cycle**  
Compressed air fills left inner chamber, causing the opposing diaphragm to create suction, lifting the lower valve ball, pulling in fluid at inlet. Simultaneously, the left chamber is in "Discharge" cycle.

**2 Discharge Cycle**  
Compressed air fills right inner chamber, causing upper valve ball to open and discharge fluid. Simultaneously, the left chamber is in "Suction" cycle.

## Installation Versatility

All installations are run-dry capable. Electricity and heat generation are not required for optimum performance.

- Suction Lift**
- Self-priming
  - High vacuum capable
  - Max lift of 32' (9.8m)

- Flooded Suction**
- Preferred for viscous fluids
  - Most common application
  - Screened inlet option

- Submerged**
- Capable of full submersion
  - Screened inlet option

NOTE: Consult your distributor or owners manual for proper materials of construction and installation for your application.

# THE SANDPIPER ADVANTAGE

WITH NEARLY 50 YEARS OF PUMPING EXPERTISE, WE PROVIDE APPLICATION DRIVEN PUMPING SOLUTIONS

**All Bolted Construction**  
Superior reliability is defined by our all bolted pump construction that allows for instant part alignment, uniform torquing of seals, and high pressure capabilities

**Various Power Sources**  
SANDPIPER pumps operate at optimum performance using compressed air, but we also have pumps available for running off of your local reserve of natural gas  
[LEARN MORE ON PAGE 46](#)

**Tested Quality**  
SANDPIPER pumps are 100% wet tested after final assembly to ensure proper functionality; Testing includes, but is not limited to, deadheading, priming, and sealing

**ESADS+Plus Air Valve**  
Externally Serviceable Air Distribution System

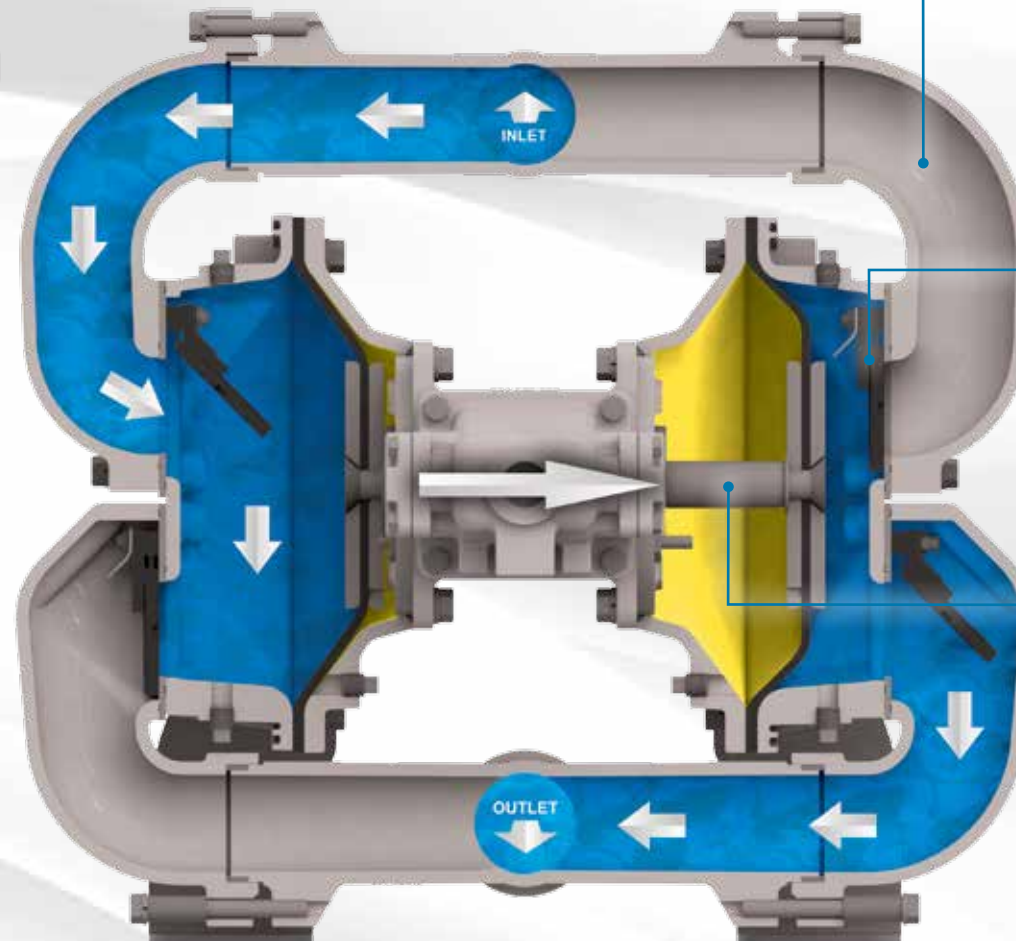
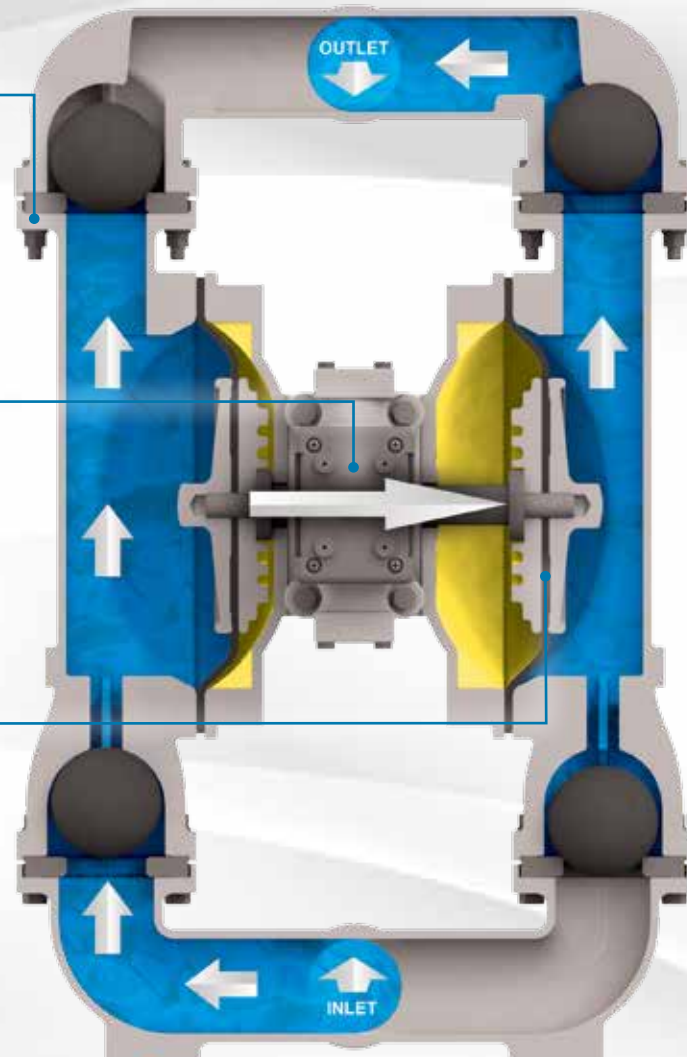

**Superior Performance**  
Hinge pads exert positive pressure on the flaps allowing the pump to operate in virtually any position, helping deliver superior suction lift and flow rates

**Flap Check Valve**  
Flap check valves allow for maximum solids passage of up to 3" (75mm)

**Guaranteed Connecting Rod**  
Our durable, corrosion resistant 416 (Martensitic) and/or 316 (Austenitic) Stainless Steel diaphragm connecting rod is guaranteed not to yield under tension, compression, or bending



**ROBUST DIAPHRAGM CONNECTING ROD**  
Guaranteed not to yield under tension, compression, or bending.



**5 YEAR LIMITED PRODUCT WARRANTY**  
5 Year Guarantee for defects in material or workmanship.



**ESADS+PLUS AIR DISTRIBUTION SYSTEM**  
Allows for quick and easy access to the pilot and spool valves.



## Bottom Discharge Porting

Eliminate the damage from settling solids in your pump, with the exclusive bottom discharge capabilities of our Heavy Duty Ball Valve and Heavy Duty Flap Valve pump lines.

Prevent broken diaphragm plates

Eliminate diaphragm rod damage

Ensure even diaphragm wear for longevity

See our connecting rod guarantee



Bottom Discharge



Top Discharge

# ENGINEERING CAPABILITIES

NO MATTER THE CIRCUMSTANCES, WE PROVIDE CUSTOM ENGINEERED SOLUTIONS TO MAXIMIZE THE PRODUCTIVITY OF ALL PROCESSES

## Custom Engineered Systems

Some examples of our custom systems include:

- Skid systems
- High pressure, filter press feed systems
- Mobile skid systems
- Custom environmental protection packaging
- Heat jacket systems
- Nuclear industry waste handling and flushing systems

## Quality Assurance

To complete the pump assembly process, the following tests are run to ensure a quality built product:

### 1. Dry Cycled Test

- Checked for rhythmic cycling
- Checked for abnormal vibrations
- Checked for motion abnormalities

### 2. Wet Cycled Test

- Checked for dry priming
- Checked for cycling characteristics
- Checked for abnormal noise levels

### 3. Vacuum Characteristics Test

### 4. Dead Head Characteristics Test

- Checked for maximum fluid pressure
- Checked for leakage
- Checked for valving bypass

### 5. Visual Inspection

- Hardware checked
- Mating surfaces checked
- Paint quality checked
- Packaging checked

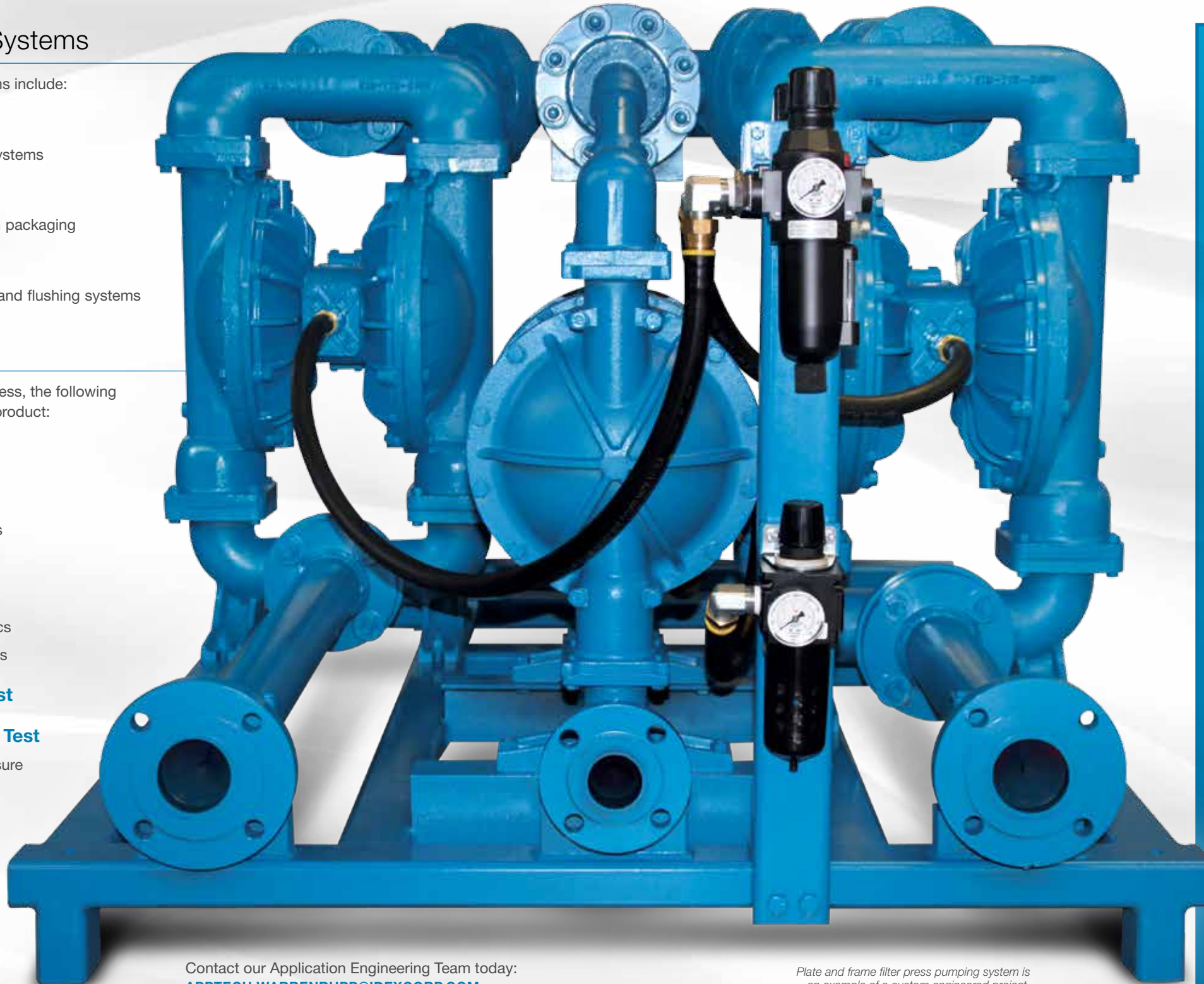

Contact our Application Engineering Team today:  
[APPTECH.WARRENRUPP@IDEXCORP.COM](mailto:APPTECH.WARRENRUPP@IDEXCORP.COM)

Plate and frame filter press pumping system is an example of a custom engineered project.

## Product Services



### Performance Testing

Assembly cycle with hold pressure vacuum readings (standard), one-point head capacity, and dry lift



### Pressure Testing

Hydro/pneumatic testing 90 psi (standard), hydro/pneumatic 1.5 times maximum operating pressure



### Repair Services

Pump repair services for labor only



### Material & Pump Certificates

Certificate of origin, conformance (pump) and compliance (material), material tests reports, non-certified or certified dimensional outlines (contact SANDPIPER Application Engineering to order)



### Custom Coating

Epoxy, water based, two part (exterior only), customer specific, PTFE, Halar®, nickel plated midsection



### Custom Products

Custom and engineered products, product dimensional outlines and systems



### Custom Nameplates

Custom stainless steel nameplates (4 lines, 24 letter maximum)



### Material Testing

PMI (Positive Material Identification), hardness testing, liquid penetrant testing, radiographic testing, magnetic particle testing, and others upon request



### Additional Pump Testing

Impact test, seismic test, sound test, and others upon request

HALAR is a registered trademark of Solvay Solexis, Inc.

# MARKETS & APPLICATIONS

SANDPIPER PUMPS ARE BUILT TO EXCEED THE DEMANDS OF YOUR SUMP WASTE TREATMENT AND OTHER APPLICATIONS LISTED BELOW

## Automotive

Applications include oil transfer, fuel transfer, machine coolant, auto wash, auto lube and much more



## Marine

Applications include oil transfer, fuel transfer, cargo cleanup, deck dewatering, cargo oil transfer, lubricants transfer and much more



## Ceramics

Applications include batching, mixing, casting machines, day tank transfer, mold filling / cleaning, glaze spray, slip transfer / recirculation and much more



## Mining

Applications include oil transfer, fuel transfer, water evacuation, mine face dewatering, drift dewatering and much more



## Chemical

Applications include packaging, drum / tote, processing, injection, mixing and much more



## Pharma / Personal Care

Applications include day tank transfer, batching, chemical feed, FDA compliant, personal hygienic / cosmetics and much more



## Coatings

Applications include pigment milling, paint filtration, mixing tanks, filling machines, tank transfer, low shear requirements and much more



## Pulp & Paper

Applications include bulk transfer, day tank transfer, batching, bleaching, converter / packaging, adhesives / ink and much more



## Construction

Applications include portable utility, oil transfer, fuel transfer, site dewatering, seal coating, road striping, municipal utility and much more



## Oil & Gas

Applications include natural gas fields, service rigs, offshore platform requirements, settling pond transfer, diesel fuel transfer, spill clean-up, salt water transfer / disposal, flare knockout and much more



## Food Processing

Applications include food packaging, product transfer, wine tank over, FDA compliance, low degradation requirements, wine fermentation / pumpover and much more



## Wastewater

Applications include municipal portable utility, neutralize wastewater, waste activated sludge, return activated sludge, thickened sludge, belt press feed and much more



SCAN FOR A COMPLETE LIST OF  
MARKETS & APPLICATIONS  
[SANDPIPERPUMP.COM/MARKETS](http://SANDPIPERPUMP.COM/MARKETS)





# PUMP SELECTION

A FUNDAMENTAL REVIEW OF FLUID CHARACTERISTICS, INTENDED INSTALLATION & DUTY REQUIREMENTS ARE RECOMMENDED FOR "BEST FIT" DESIGN SELECTIONS

## Pump Characteristics

Whether measuring mean time between failures, repairs, changes or maintenance, this design selection best practice will ensure the longest pump life.

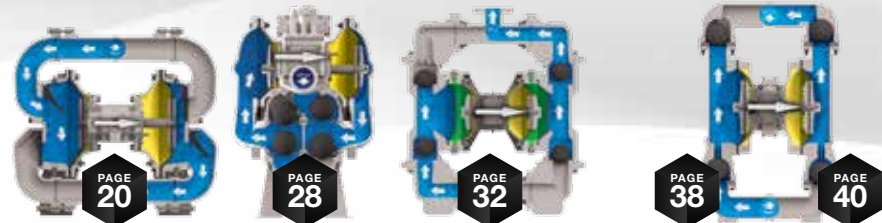

SIGNATURE CONFIGURATIONS		Heavy Duty Flap Valve	Heavy Duty Ball Valve	Containment Duty Ball Valve	Standard Duty Ball Valve - Metallic	Standard Duty Ball Valve - Non-Metallic
Specifications	Suction / Discharge Port Sizes	1" through 4"	1" through 4"	1" through 3"	¼" through 3"	¼" through 3"
	Max Flow Rate Per Minute	310 Gal. (1173 L)	300 Gal. (1136 L)	260 Gal. (988 L)	285 Gal. (1079 L)	280 Gal. (1060 L)
	Max Discharge Heads	289' (88m) of water @125psi	289' (88m) of water @125psi	289' (88m) of water @125psi	289' (88m) of water @125psi	231' (70m) of water @100psi
	Max Displacement Per Stroke	1.62 Gal. (6.15 L)	1.8 Gal. (6.8 L)	1.25 Gal. (4.73 L)	0.94 Gal. (3.56 L)	0.9 Gal. (3.41 L)
	Max Dry Prime	24' (7m)	20' (6m)	18' (5.5m)	20' (6m)	20' (6m)
	Max Solids Handling	3" (75mm)	.88" (22mm)	.44" (10mm)	.38" (10mm)	.71" (18mm)
Fluid Characteristics	Water	+	+	+	+	+
	Suspended Solids	+	+	✓	+	✓
	Non-Suspended Solids	+	!	X	!	X
	Line Size Solids	+	X	X	X	X
	Sludge / Slurry	+	+	!	✓	!
	High Viscosity (Flowable Fluids)	✓	+	✓	✓	✓
	Erosion / Abrasive Fluids	High	+	+	!	!
Moderate	+	+	!	✓	!	
Low	+	+	✓	+	✓	
Corrosion	✓	✓	+	✓	+	
Installation	Permanent	+	+	✓	✓	✓
	Portable	+	+	+	+	+
	Containment / Prevention	!	!	+	!	!
	Flooded Suction	✓	+	✓	✓	✓
	Suction Lift	+	✓	✓	✓	✓
	Submerged	✓	✓	!	✓	!
Duty	Intermittent / On-Demand	+	+	+	+	+
	Continuous	✓	+	✓	✓	✓

+ = Best Type   ✓ = Suitable   ! = Limitations   X = Not Recommended

## Pump Performance

- Select Flow Rate (GPM)**  
Example: 80 GPM
- Determine Discharge Head (PSI)**  
Example: 45 PSI
- See Inlet Air Pressure (PSI)**  
Example: 78 PSI
- See Air Consumption (SCFM)**  
Example: 60 SCFM

### Selection Tip: Size-Up

See the MTBF section below to learn the impact of sizing up your pump to increase energy savings and reduce wear on the pump to measurably reduce total cost of ownership

**2" Curve Example:** 80 GPM, 45 PSI = 60 SCFM.

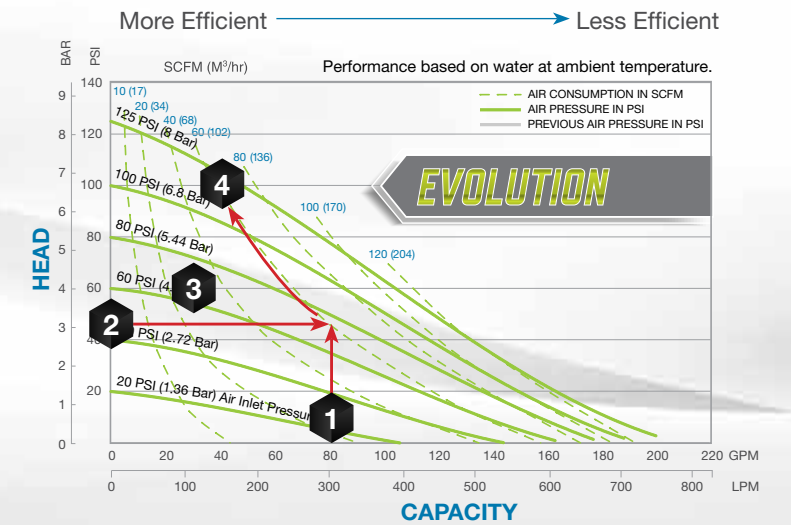

## Sizing to Extend Mean Time Between Failures

Pumping requirements (flow & head) for most applications can be met by multiple sizes of pumps. Talk to SANDPIPER'S application engineers to assist you with a size selection which best fits your total cost of ownership budget. An appropriately sized-up pump will lower the consolidated initial investment, repair, labor and energy costs. This **BEST PRACTICE** ensures desirable returns on the initial investment frequently measurable in weeks.

Experienced application engineers are available to help you determine the best fit pump size for your application. Call our factory or email: [APPTech.WARRENrupp@IDEXCORP.COM](mailto:APPTech.WARRENrupp@IDEXCORP.COM)

**1½" Standard Duty**  
30 PSI, 80 GPM = 90 SCFM

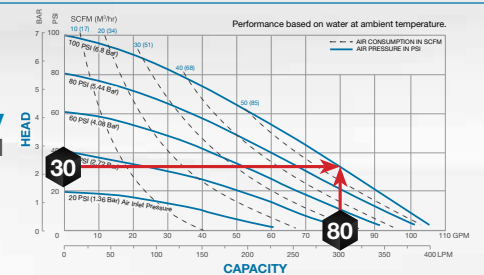

**3" Standard Duty**  
30 PSI, 80 GPM = 38 SCFM

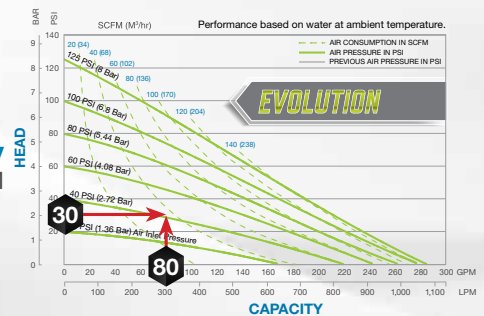

## Additional Resources

**Technical Resources**  
Find further information on sizing and selection of SANDPIPER products at [SANDPIPERPUMP.COM/TECH\\_RESOURCES](http://SANDPIPERPUMP.COM/TECH_RESOURCES)

**Chemical Guide**  
Available as both a free mobile app or PDF, this chemical compatibility guide will help you zero in on the pump that fits your process best. [SANDPIPERPUMP.COM/CHEM](http://SANDPIPERPUMP.COM/CHEM)

# EXCLUSIVE PUMP CONFIGURATIONS

WITH THE BROADEST RANGE OF CONFIGURATIONS, SANDPIPER HAS A SOLUTION FOR YOUR PUMPING PROBLEM, WITH MORE WAYS THAN ONE



PG. 20

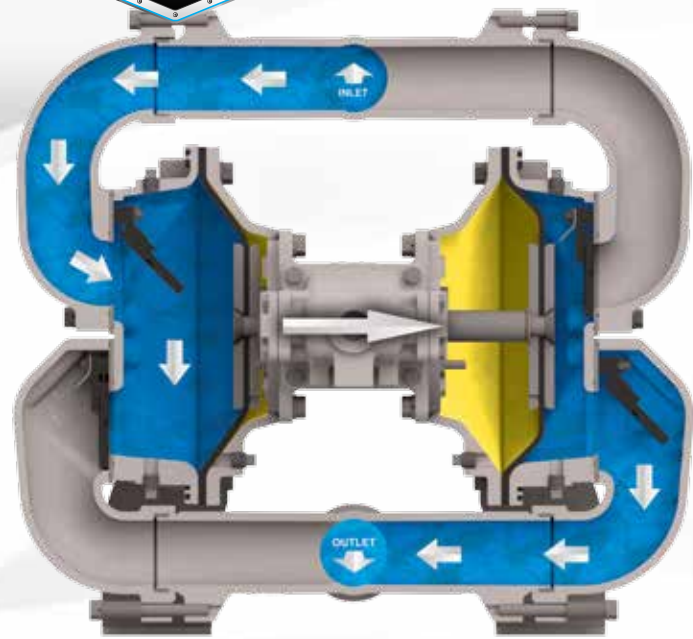

**HEAVY DUTY FLAP VALVE**

**Unique features for this configuration include:**

- Pumps up to line size solids
- Bottom discharge porting, discharges settling solids
- Superior suction lift of up to 24 ft.
- Easy access to serviceable components
- Thick manifold and chamber walls
- Diaphragm wear pads extend service life



PG. 28



**HEAVY DUTY BALL VALVE**

**Unique features for this configuration include:**

- Down ported option, discharges settling solids
- Weighted check balls for handling viscous fluids
- Top ported option, discharges floating solids, suspended solids or entrained gases
- Side ported option for use in confined spaces
- Thick manifold and chamber walls
- Diaphragm wear pads extend service life



PG. 32

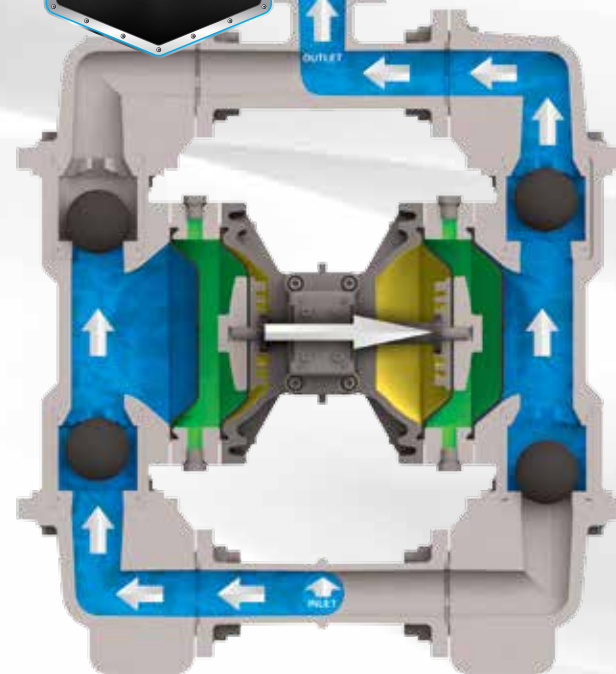

**CONTAINMENT DUTY BALL VALVE**

**Unique features for this configuration include:**

- Containment chamber with leak detection
- Hydraulically balanced / coupled pumping and driver diaphragm assemblies
- Solids range +.25" (6mm) to .71" (18mm)
- Dry primes up to 18' of water
- Free standing support base

PG. 36

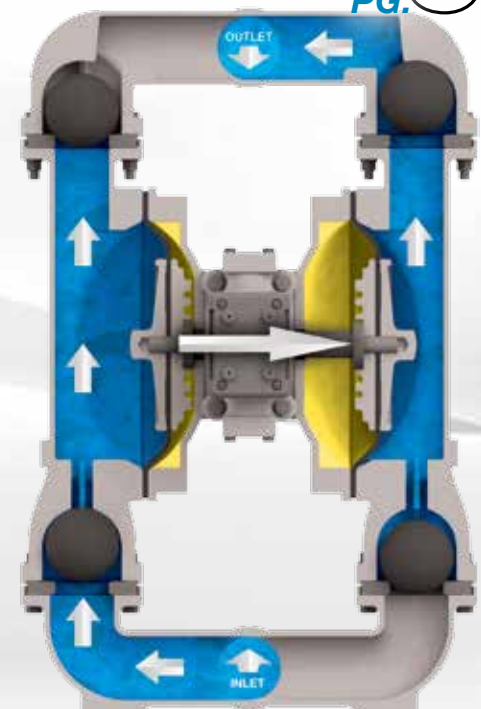

**STANDARD DUTY BALL VALVE**

**Unique features for this configuration include:**

- Solids range +.03" (1mm) to .71" (18mm)
- Dry primes up to 20' of water
- ESADS+ Air Distribution System



**ALL SANDPIPER PUMPS** feature the exclusive ESADS+Plus performance guaranteed, in-line serviceable, air valve system.

SCAN TO LEARN MORE  
SANDPIPERPUMP.COM/ESADS



**ALL SANDPIPER PUMPS** come with a guaranteed diaphragm connecting rod.

# HEAVY DUTY FLAP VALVE PUMPS

**FOR FLUIDS CONTAINING UP TO LINE SIZE SOLIDS**

HDF Pumps are recommended for abrasive slurries, suspended and non-suspended solids and line-size solids requirements. All SANDPIPER Heavy Duty Flap Valve Pumps are configured in bottom discharge porting arrangements and provide superior suction lift. HDF pumps are thick wall constructed of Sand Casted Aluminum, Cast Iron and Stainless Steel with elastomer, TPE (thermal plastic elastomers) and PTFE options in diaphragms and check valves. HDF pumps are enhanced with an extended wear package.

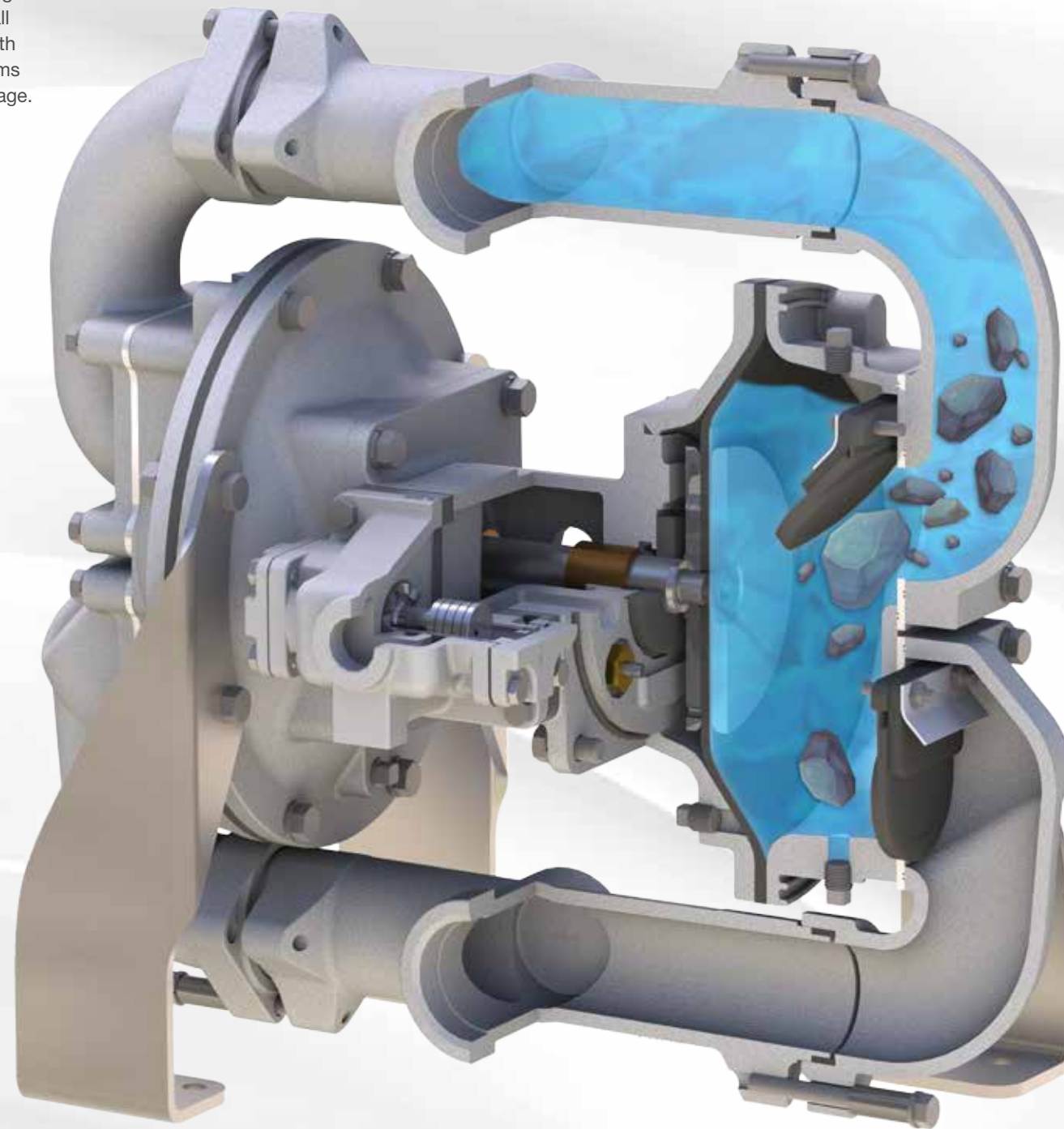

**Durable Diaphragm Connecting Rods**  
Reliable and consistent diaphragm control

**Lightweight & Portable**  
Weights range from 48 lbs (21 kg)

**ESADS+Plus Air Valve**  
Externally Serviceable Air Distribution System

**Bottom Discharge**  
For pumping out of tough areas

**Flap Check Valves**  
Provide large solid abilities

**All Bolted Construction**  
Durable and high pressure capable

**Dynamic Manifold Connections**  
90° - 180° rotation options

**Solids Range**  
+1" (25mm) to 3" (75mm)

**Superior Dry Prime**  
Up to 24' (7m) of water

**Certifications Available**  
CE, Ex, ATEX

PUMP CHARACTERISTICS		Metallic
Fluid Characteristics	Water	+
	Suspended Solids	✓
	Non-Suspended Solids	+
	Line Size Solids	+
	Sludge / Slurry	+
	High Viscosity (Flowable Fluids)	✓
	Erosion / Abrasive Fluids	High
Moderate		+
Low		+
Corrosion	✓	
Installation	Permanent	+
	Portable	+
	Containment / Prevention	!
	Flooded Suction	✓
	Suction Lift	+
	Submerged	✓
Duty	Intermittent / On-Demand	+
	Continuous	✓

+ = Best Type    ✓ = Suitable    ! = Limitations    X = Not Recommended

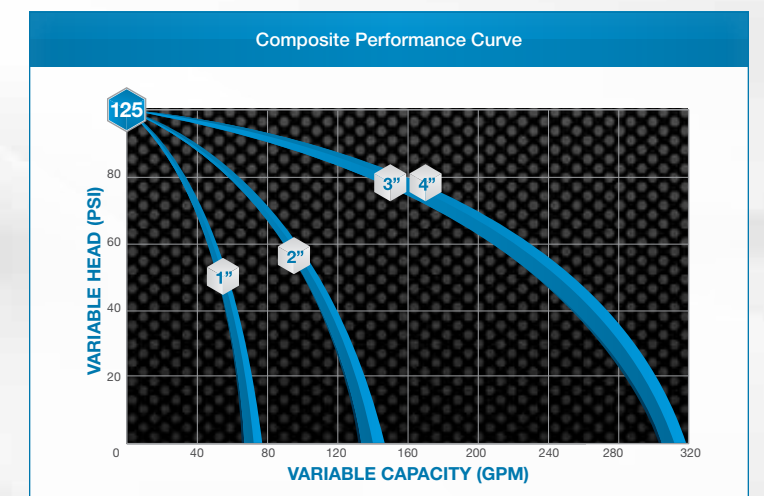

# HEAVY DUTY FLAP VALVE PUMPS

PERFORMANCE & SPECIFICATIONS

1"  
25mm

## HDF1 Metallic Performance



- MAX FLOW** • 70 GPM (265 LPM)  
**PORTING** • NPT / BSP  
**AIR END** • Aluminum • Cast Iron  
**WET END** • Aluminum • Stainless Steel • Cast Iron

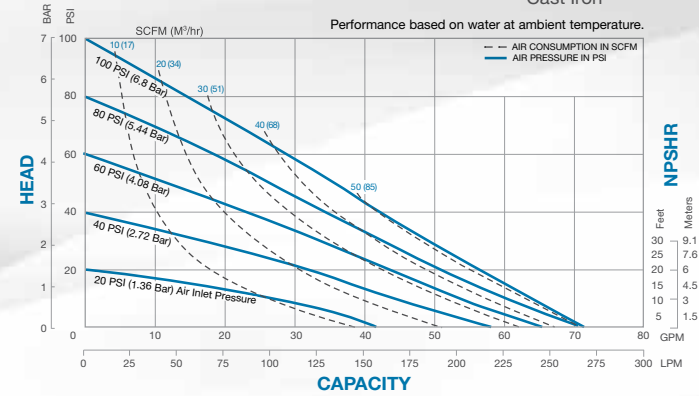

2"  
50mm

## HDF2 Metallic Performance



- MAX FLOW** • 208 GPM (787 LPM)  
**PORTING** • NPT / BSP  
**AIR END** • Aluminum • Cast Iron  
**WET END** • Aluminum • Stainless Steel • Cast Iron

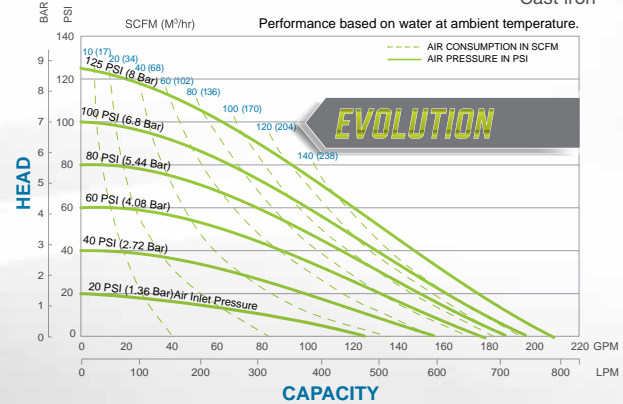

3-4"  
75-102mm

## HDF3-A / 4-A Metallic Performance



- MAX FLOW** • 310 GPM (1173 LPM)  
**PORTING** • ANSI Flange  
**AIR END** • Aluminum  
**WET END** • Aluminum

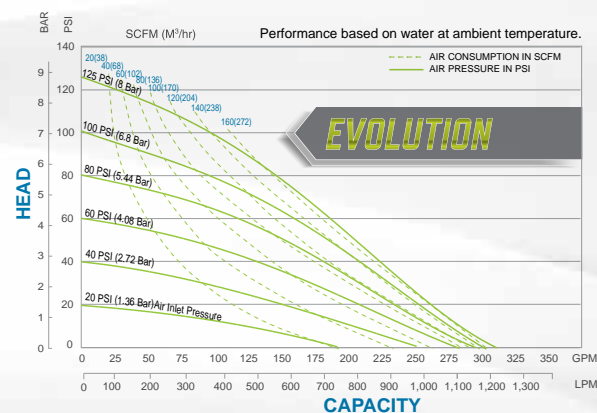

3-4"  
75-102mm

## HDF3-M / 4-M Metallic Performance



- MAX FLOW** • 303 GPM (1147 LPM)  
**PORTING** • ANSI Flange  
**AIR END** • Cast Iron  
**WET END** • Cast Iron

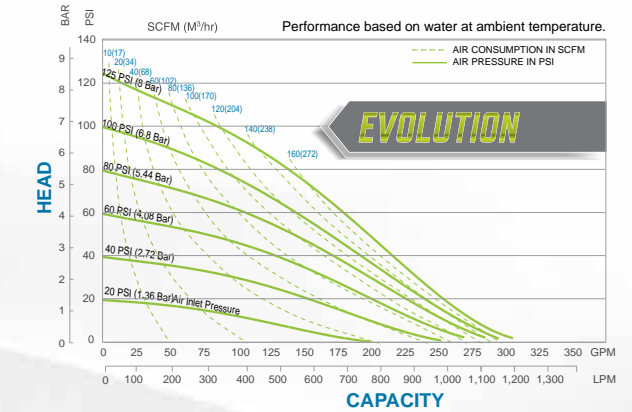

1"  
25mm

## SA1 Metallic Performance



- MAX FLOW** • 42 GPM (159 LPM)  
**PORTING** • NPT / BSP  
**AIR END** • Aluminum • Cast Iron  
**WET END** • Aluminum • Stainless Steel

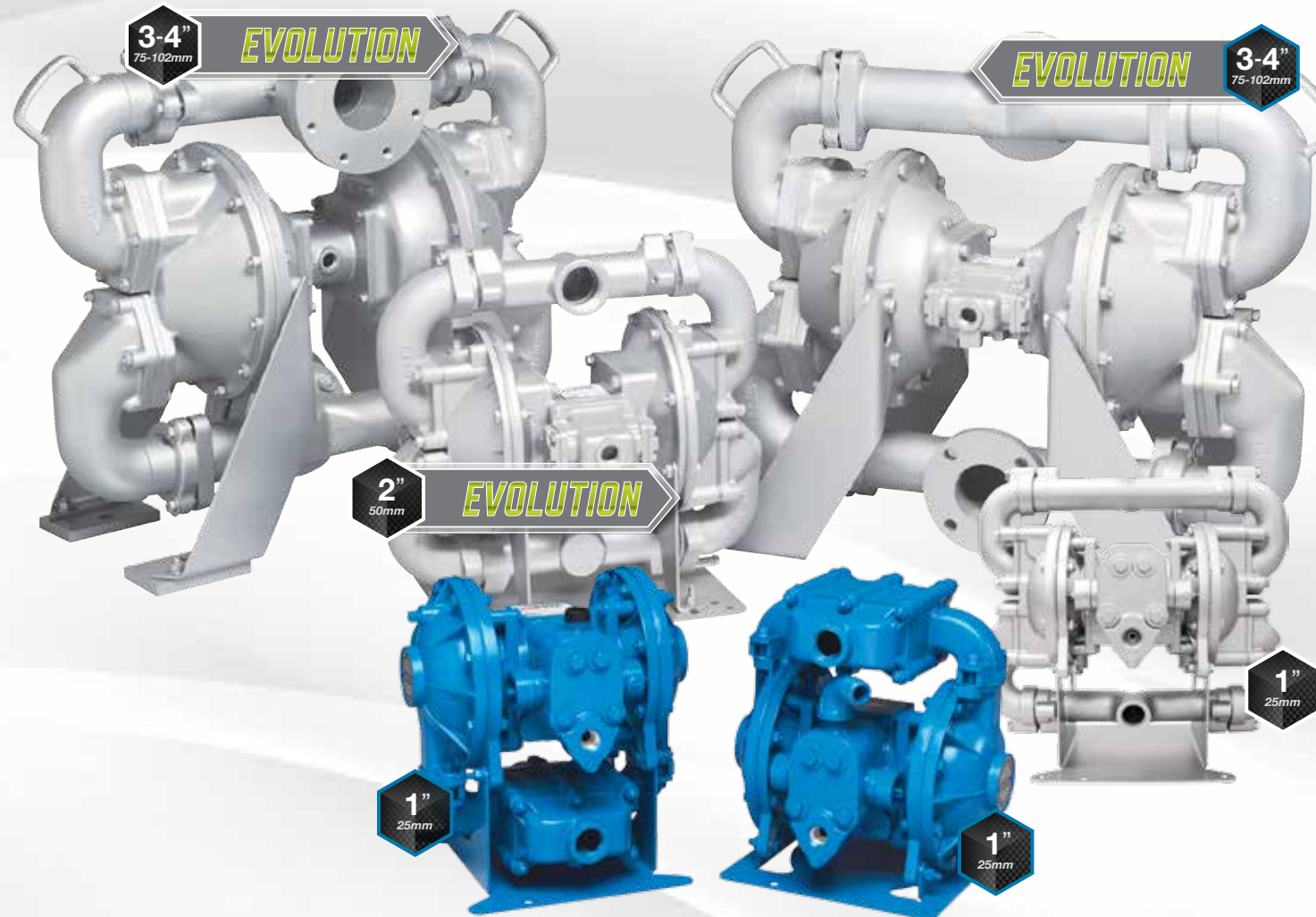
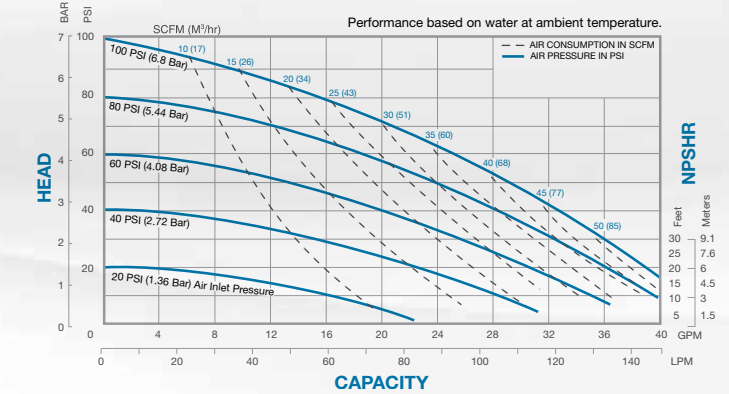

Bottom Discharge

Top Discharge

### SPECIFICATIONS

PUMP MODELS	A	B	C	D	E	Connection Style	Pipe Size	Displacement Per Stroke	Max Flow Per Minute	Max Solids Handling	Max Discharge Pressure
	Height	Width	Depth	Bottom of Base to Center Line of Suction	Bottom of Base to Center Line of Discharge		inch (mm)	gal (liter)	gal (liter)	inch (mm)	psi (bar)
HDF1	15.69 (398)	16.75 (425)	10.81 (274)	14.06 (356)	2.56 (65)	1" NPT / BSP	1 (25)	.10 (.38)	70 (265)	1 (25)	125 (8.6)
HDF2	20.31 (516)	21.75 (552)	13.63 (346)	17.69 (449)	2.56 (65)	2" NPT only	2 (50)	.47 (1.78)	208 (787)	2 (50)	125 (8.6)
HDF3-A	29.5 (749)	36.56 (929)	16.25 (413)	25.75 (654)	4.25 (108)	3" 125# ANSI	3 (75)	1.60 (6.06)	310 (1173)	3 (75)	125 (8.6)
HDF3-M	30.25 (768)	32.31 (821)	16.19 (411)	26.5 (673)	5 (127)	3" 125# ANSI	3 (75)	1.15 (4.35)	303 (1147)	3 (75)	125 (8.6)
HDF4-A	31 (787)	36.56 (929)	21.25 (540)	26.5 (673)	5 (127)	4" 125# ANSI	4 (102)	1.60 (6.06)	310 (1173)	3 (75)	125 (8.6)
HDF4-M	31 (787)	32.31 (821)	16.19 (411)	26.5 (673)	5 (127)	4" 125# ANSI	4 (102)	1.15 (4.35)	303 (1147)	3 (75)	125 (8.6)
SA1	12.38 (314)	11.36 (288)	11.26 (286)	10.69 (271)	10.69 (271)	1" NPT / BSP	1 (25)	.09 (.34)	42 (159)	1 (25)	125 (8.6)

Dimensional Tolerance: ±1/8" (± 3mm) • See service manual for complete specifications.

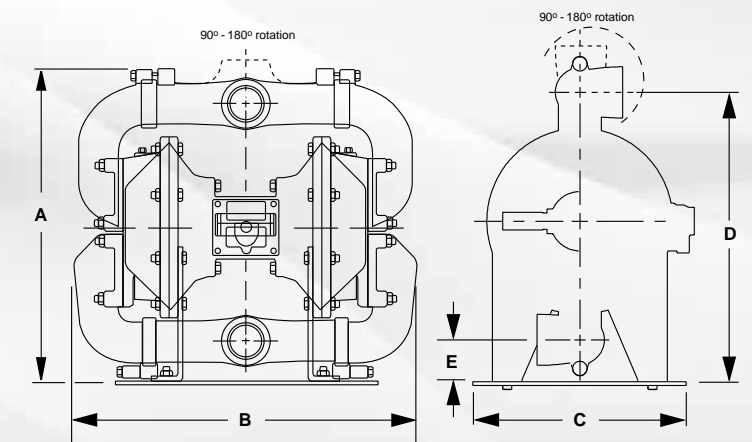

# 2" NON-METALLIC FLAP VALVE PUMP

**YOUR MINING, GENERAL INDUSTRIAL AND CHEMICAL SOLUTION**

The robust, yet lightweight design allows for ease of maintenance and movement, and is ideal for handling solids and corrosive fluids. This unique pump has been engineered to fully function in any position, includes lifting handles and hanging points, and has durable mounting feet. This is an ideal solution for numerous applications.

**Lightweight & Durable**  
The non-metallic, lightweight design makes it easily portable at 53 lbs (24 kg)

**Reliability Guarantee**  
Strongest diaphragm connecting rod in the industry is guaranteed to not bend or yield in operation

**Rugged Design**  
Stainless steel seats prevent abrasion when pumping solids laden fluids

**Optimum Solids Handling**  
Hinge pads exert positive pressure on the flaps, allowing the pump to operate in virtually any position; they help deliver superior suction lift and flow rates

**Long Life**  
A proven diaphragm design in conjunction with exclusive wear pads reduce plate abrasion, delivering extended life

**Purpose Built Base**  
The threaded version features stainless steel mounting feet and the flanged version features Polypropylene mounting feet

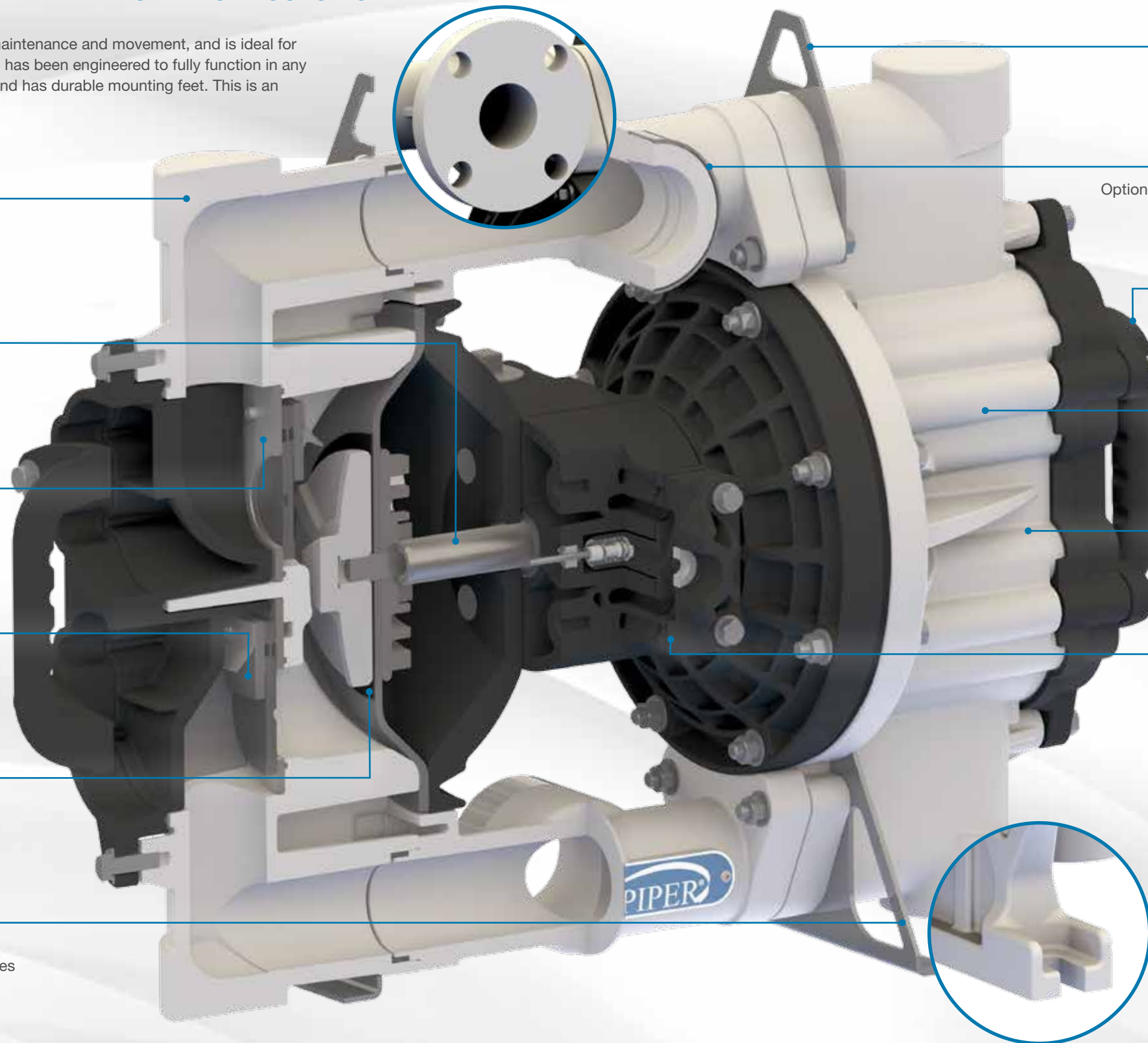

**Industrial Mounting Capabilities**  
Addition of stainless steel hanging points located on the manifold allow for multiple mounting options

**Strong Manifold Connections**  
Optional flanged or threaded connection for additional flexibility: Stainless steel reinforcing rings help protect the threaded manifold connections from being damaged

**Ergonomic Handle**  
Lifting handles come standard, allowing for easy pump transport; handles can be rotated 90 degrees for proper ergonomics, depending on desired use

**Unsurpassed Performance**  
Industry leading flow rates, suction lift, air efficiency and displacement per stroke

**Versatile Design**  
This pump will function in any position, including uneven surfaces

**Simple Maintenance**  
With our signature ESADS+Plus (Externally Serviceable Air Distribution System) air valve design and externally serviceable flap valve modules, in-field service is quick and easy, saving you from unnecessary downtime



Visit [SANDPIPERPUMP.COM/ESADSVideos](http://SANDPIPERPUMP.COM/ESADSVideos) to see how easy the ESADS air valve makes maintaining the 2" Non-Metallic Flap Valve.

# HEAVY DUTY NON-METALLIC FLAP VALVE PUMP

PERFORMANCE & SPECIFICATIONS

2"  
50mm

## HD20F Non-Metallic Performance



- MAX FLOW**  
• 150 GPM (567 LPM)
- PORTING**  
• NPT / BSPT
- AIR END**  
• Polypropylene
- WET END**  
• Polypropylene  
• Stainless Steel (seats only)

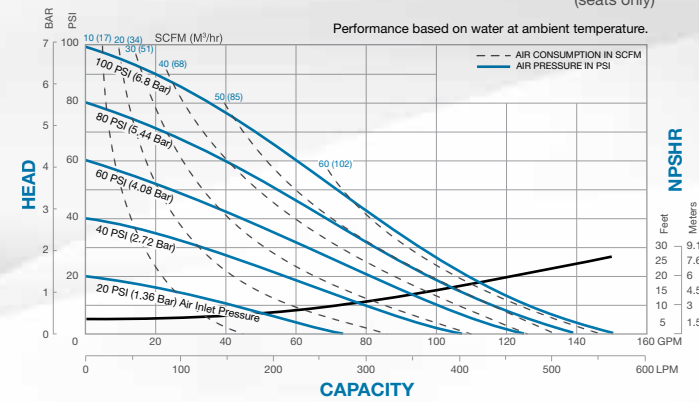

## Ease of Valve Maintenance

To help increase productivity and reduce downtime, the 2" Non-Metallic Flap Valve Pump was engineered with ease of maintenance in mind.

## QUICK ACCESS TO SERVICEABLE COMPONENTS

### 1. Remove Clean-Out Cap

By simply removing six bolts securing the clean-out cap in place, it allows access to clear simple clogs without disassembling the entire pump.

### 2. Modular Check Valve Access

With the clean-out cap removed, the flap valves can be inspected and / or replaced as needed. Four bolts hold the modular flap valves in place for quick maintenance and repair.

### 3. ESADS+Plus

Proven air distribution system allows for maintenance and / or repair of both pilot valve and air valve components without removing the pump from service.

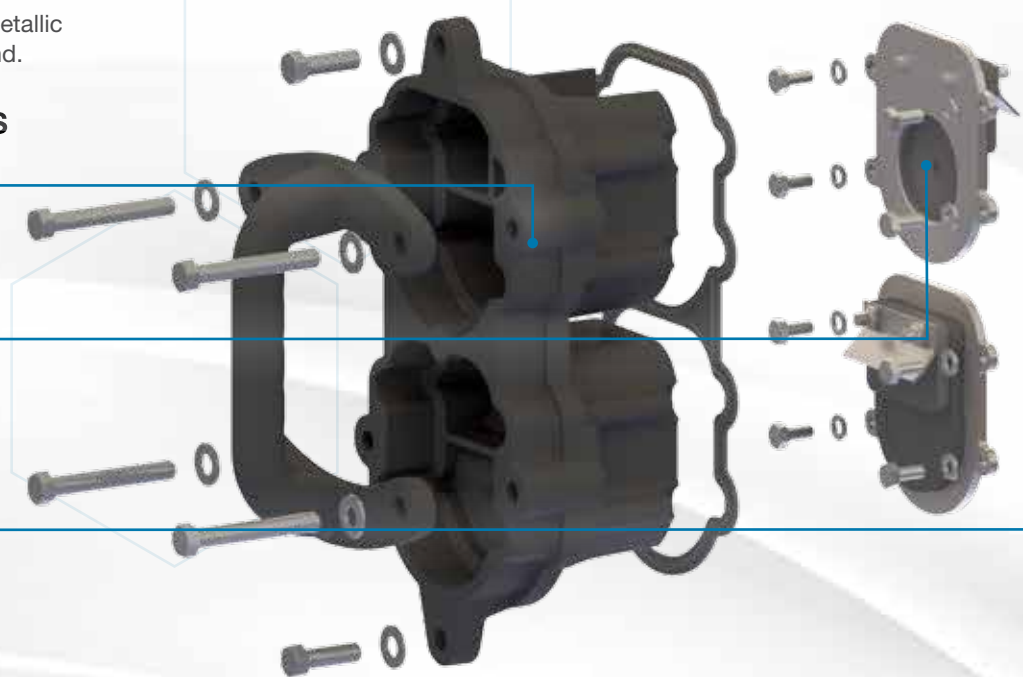

Visit [SANDPIPERPUMP.COM/ESADSVIDEO](http://SANDPIPERPUMP.COM/ESADSVIDEO) to see how easy the ESADS air valve makes maintaining the 2" Non-Metallic Flap Valve.

## SPECIFICATIONS

PUMP MODEL	A	B	C	D	E	Connection Style	Pipe Size	Displacement Per Stroke	Max Flow Per Minute	Max Solids Handling	Max Discharge Pressure
	Height	Width	Depth	Bottom of Base to Center Line of Suction	Center Line of Discharge		inch (mm)	gal (liter)	gal (liter)	inch (mm)	psi (bar)
HD20F	20.89 (531)	29.7 (754)	12.65 (321)	17.56 (446)	2 (50)	2" NPT / BSPT	2 (50)	.50 (1.9)	150 (567)	1.8 (46)	100 (7)

Dimensional Tolerance: ±1/8" (± 3mm) • See service manual for complete specifications.

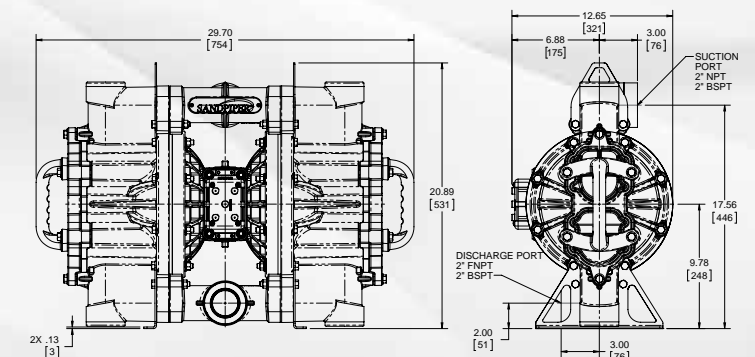

# HEAVY DUTY BALL VALVE PUMPS

**FOR FLUIDS CONTAINING SETTLING, SUSPENDED & FLOATING SOLIDS**

HDB Metallic Pumps are ideal for thin to highly viscous and small solids-laden fluids, while providing excellent suction lift capability and exclusive variable porting options (side, top, bottom and dual). HDB pumps are thick wall constructed of Sand Casted Aluminum, Cast Iron, Stainless Steel or Alloy C with elastomer, TPE (thermal plastic elastomers) and PTFE options in diaphragms and check valves. HDB pumps are enhanced with an extended wear package.



**Top Porting Position**

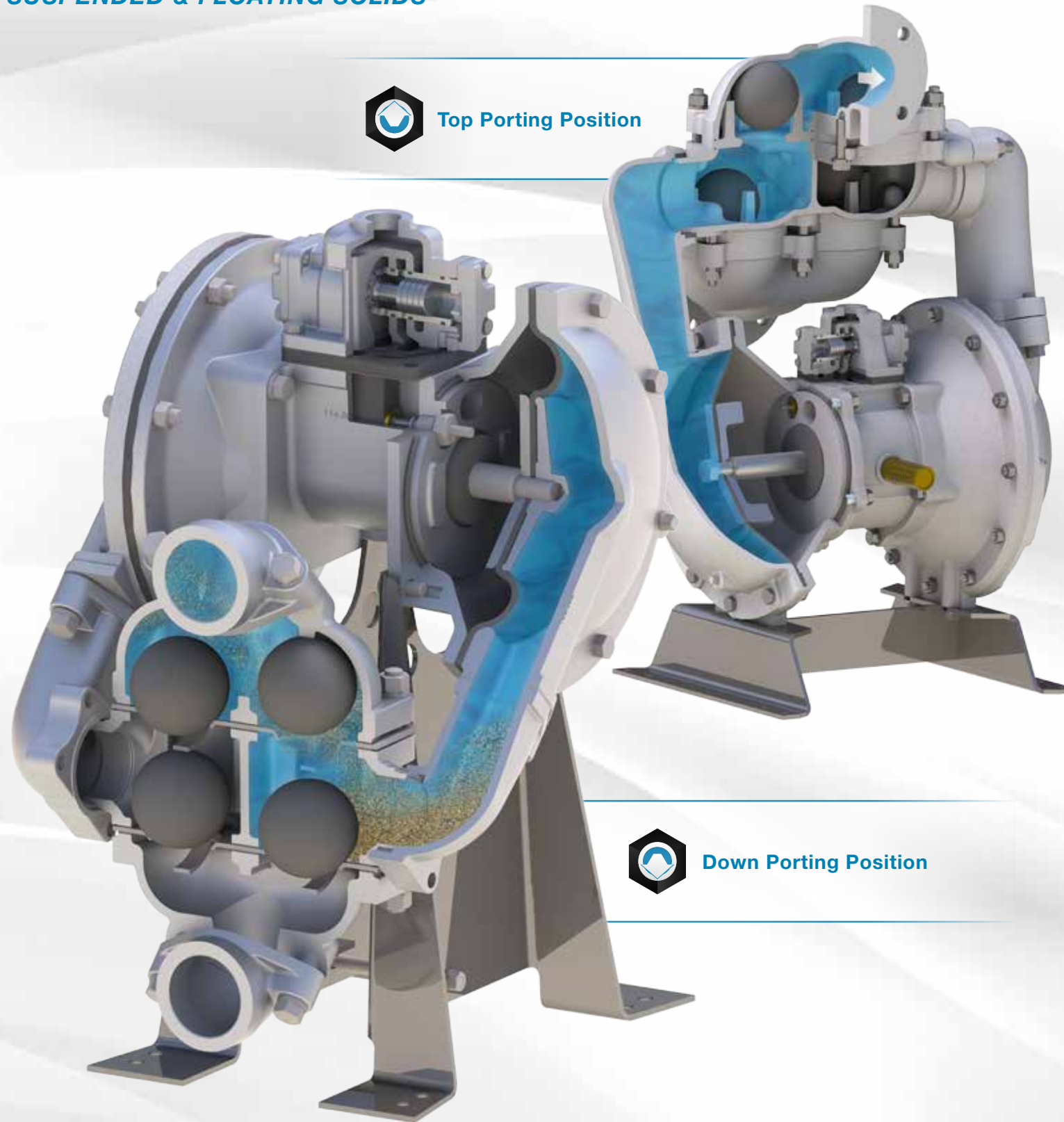

**Down Porting Position**



**Bottom or Top Porting Positions**

Greater process connection flexibility



**All Bolted Construction**

Durable and high pressure capable



**Lightweight & Portable**

Weights as low as 31 lbs (14 kg)



**Ball Check Valves**

Provide powerful, high flow pumping



**Diaphragm Connecting Rods**

Reliable and consistent diaphragm control



**ESADS+Plus Air Valve**

Externally Serviceable Air Distribution System



**Dynamic Manifold Connections**

Can be vertically or horizontally mounted



**Certifications Available**



PUMP CHARACTERISTICS		Metallic
Fluid Characteristics	Water	+
	Suspended Solids	+
	Non-Suspended Solids	+
	Line Size Solids	X
	Sludge / Slurry	+
	High Viscosity (Flowable Fluids)	+
	Erosion / Abrasive Fluids	High
Moderate		+
Low		+
Corrosion	✓	
Installation	Permanent	+
	Portable	✓
	Containment / Prevention	!
	Flooded Suction	+
	Suction Lift	✓
	Submerged	✓
Duty	Intermittent / On-Demand	+
	Continuous	+

+ = Best Type    ✓ = Suitable    ! = Limitations    X = Not Recommended

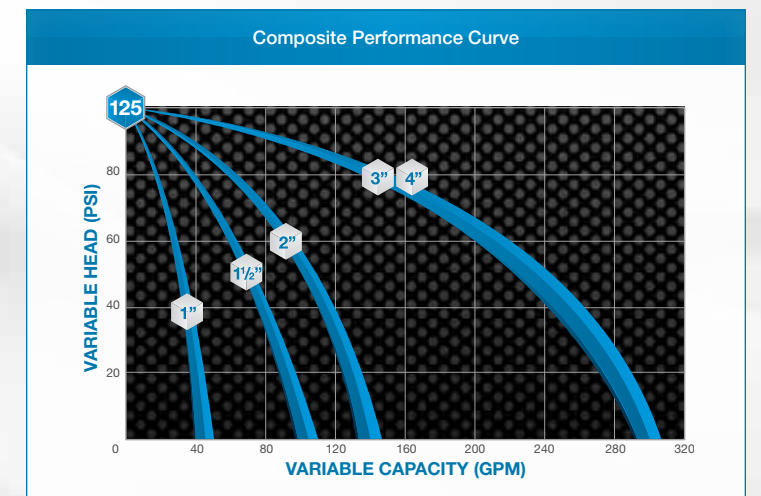

# HEAVY DUTY BALL VALVE PUMPS

PERFORMANCE & SPECIFICATIONS

**1 1/2"**  
38mm

## HDB1 1/2 Metallic Performance



- MAX FLOW**  
• 122 GPM (462 LPM)
- PORTING**  
• NPT / BSP
- AIR END**  
• Aluminum  
• Cast Iron
- WET END**  
• Aluminum  
• Stainless Steel  
• Alloy C  
• Cast Iron

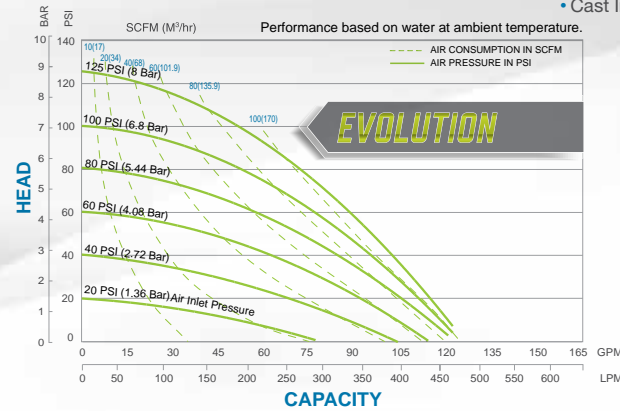

**2"**  
50mm

## HDB2 Metallic Performance



- MAX FLOW**  
• 135 GPM (511 LPM)
- PORTING**  
• NPT
- AIR END**  
• Aluminum  
• Cast Iron
- WET END**  
• Aluminum  
• Stainless Steel  
• Alloy C  
• Cast Iron

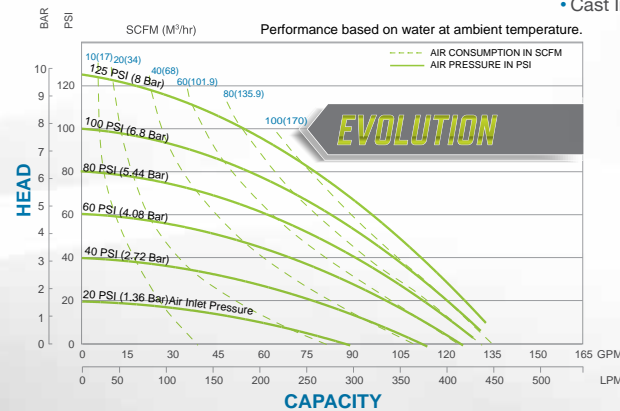

**3-4"**  
75-102mm

## HDB3 / HDB4 Metallic Performance



- MAX FLOW**  
• 300 GPM (1136 LPM)
- PORTING**  
• ANSI Flange
- AIR END**  
• Cast Iron
- WET END**  
• Stainless Steel  
• Cast Iron

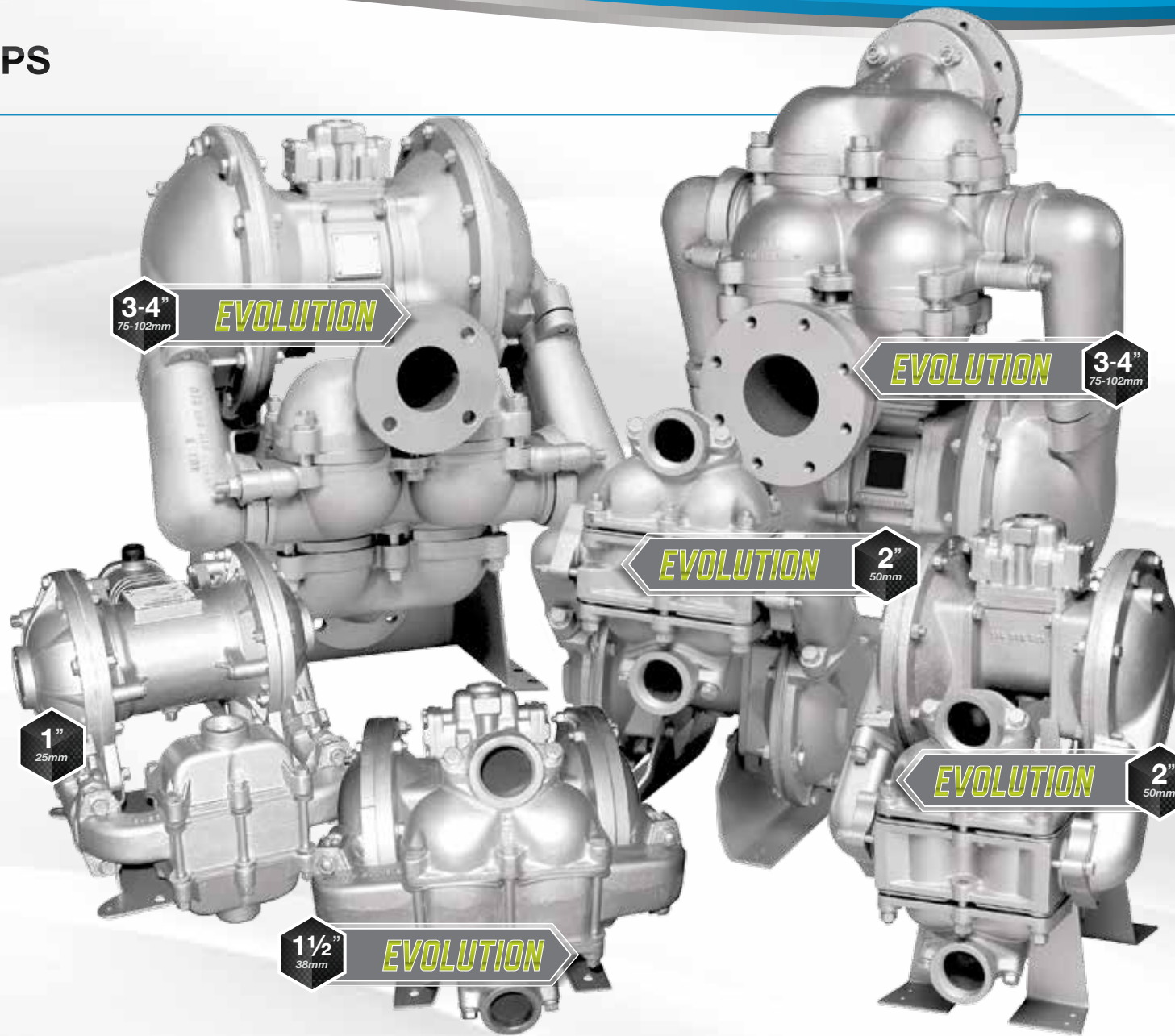
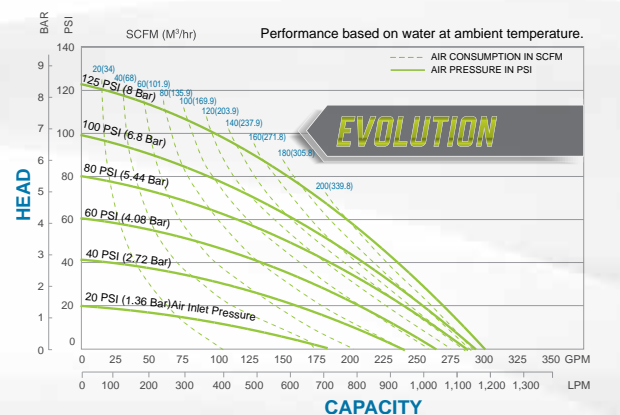

**1"**  
25mm

## SB1 / SB25 Metallic Performance



- MAX FLOW**  
• 42 GPM (159 LPM)
- PORTING**  
• NPT / BSP
- AIR END**  
• Aluminum  
• Cast Iron
- WET END**  
• Aluminum  
• Stainless Steel  
• Alloy C

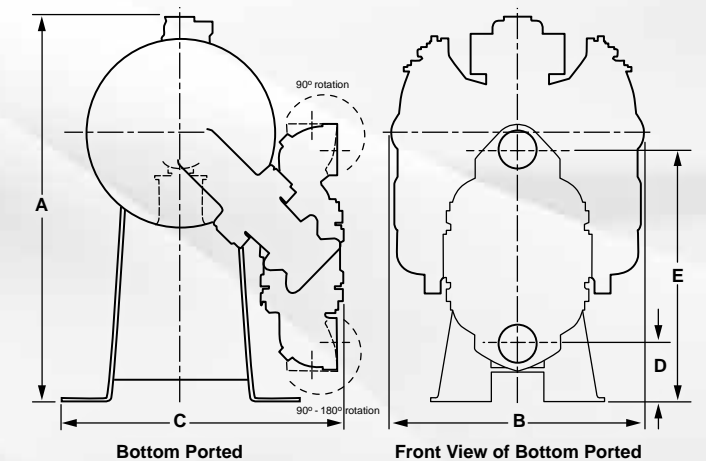
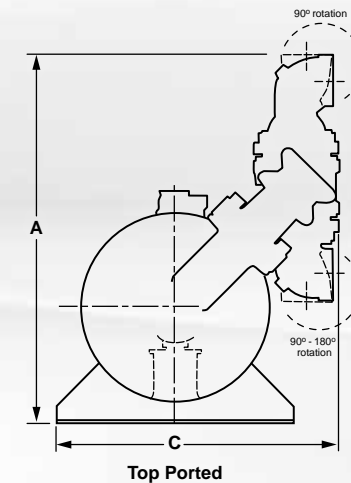
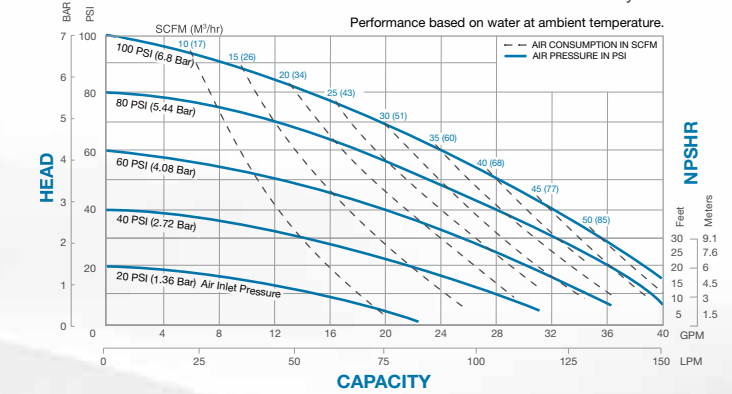

PUMP MODELS	SPECIFICATIONS					Connection Style	Pipe Size	Displacement Per Stroke	Max Flow Per Minute	Max Solids Handling	Max Discharge Pressure
	A	B	C	D	E						
	Height	Width	Depth	Bottom of Base to Center Line of: Suction	Discharge						
	inches (mm)	inches (mm)	inches (mm)	inches (mm)	inches (mm)		inch (mm)	gal (liter)	gal (liter)	inch (mm)	psi (bar)
SB1 / SB25	14.44 (367)	11.75 (298)	13.28 (337)	5.25 (133)	13 (330)	1" NPT/BSP	1 (25)	.09 (.34)	42 (159)	.25 (6)	125 (8.6)
SB1 TOP	13.5 (342)	11.75 (298)	14.88 (378)	5.62 (142)	13.5 (342)	1" NPT/BSP	1 (25)	.09 (.34)	42 (159)	.25 (6)	125 (8.6)
SB1 BOTTOM	13.69 (347)	11.75 (298)	14.88 (378)	2.22 (21)	8.44 (214)	1" NPT/BSP	1 (25)	.09 (.34)	42 (159)	.25 (6)	125 (8.6)
HDB1 1/2 TOP	19.22 (488)	15.5 (419)	17 (432)	8.14 (207)	18.08 (459)	1 1/2" NPT/BSP	1.5 (38)	.37 (1.4)	122 (462)	.25 (6)	125 (8.6)
HDB1 1/2 BOTTOM	18.56 (471)	15.5 (419)	17 (432)	6.14 (156)	16 (406)	1 1/2" NPT/BSP	1.5 (38)	.37 (1.4)	122 (462)	.25 (6)	125 (8.6)
HDB2 TOP	22.19 (564)	15.5 (394)	16.81 (427)	9.12 (232)	20.88 (530)	2" NPT	2 (50)	.46 (1.7)	135 (511)	.38 (9)	125 (8.6)
HDB2 BOTTOM	23.25 (591)	15.5 (394)	16.81 (427)	3.44 (87)	15.19 (386)	2" NPT	2 (50)	.46 (1.7)	135 (511)	.38 (9)	125 (8.6)
HDB3 TOP	37.13 (943)	26 (661)	20.75 (527)	20 (509)	33.33 (848)	3" 125# ANSI	3 (75)	2.0 (7.6)	300 (1136)	.87 (22)	125 (8.6)
HDB3 BOTTOM	31.25 (794)	26 (661)	24.62 (625)	5.75 (146)	19.33 (492)	3" 125# ANSI	3 (75)	2.0 (7.6)	300 (1136)	.87 (22)	125 (8.6)
HDB4 TOP	37.88 (962)	26 (661)	23.75 (603)	20 (509)	33.33 (848)	4" 125# ANSI	4 (102)	2.0 (7.6)	300 (1136)	.87 (22)	125 (8.6)
HDB4 BOTTOM	31.25 (793)	26 (661)	27.5 (699)	5.75 (146)	19.33 (492)	4" 125# ANSI	4 (102)	2.0 (7.6)	300 (1136)	.87 (22)	125 (8.6)

Dimensional Tolerance: ±1/8" (± 3mm) • See service manual for complete specifications.



# CONTAINMENT DUTY BALL VALVE PUMPS

THE ONLY COMPLETE LINE OF AODD PUMPS FEATURING SUPERIOR FLUID CONTAINMENT; PROTECTING YOUR PEOPLE, ENVIRONMENT, AND PUMP.

Containment Duty Metallic and Non-Metallic Pumps are ideal for highly corrosive and hazardous chemical fluid requirements. All containment duty pumps are exclusively designed with containment chambers, hydraulically balanced/coupled pumping diaphragm and driver diaphragm assemblies. All containment chambers are designed to accommodate visual, mechanical and low voltage leak detection devices. CD pumps are constructed of Aluminum, Cast Iron, Stainless Steel, Alloy C, Polypropylene and PVDF with TPE (thermal plastic elastomers), PTFE options in diaphragms and check valves.

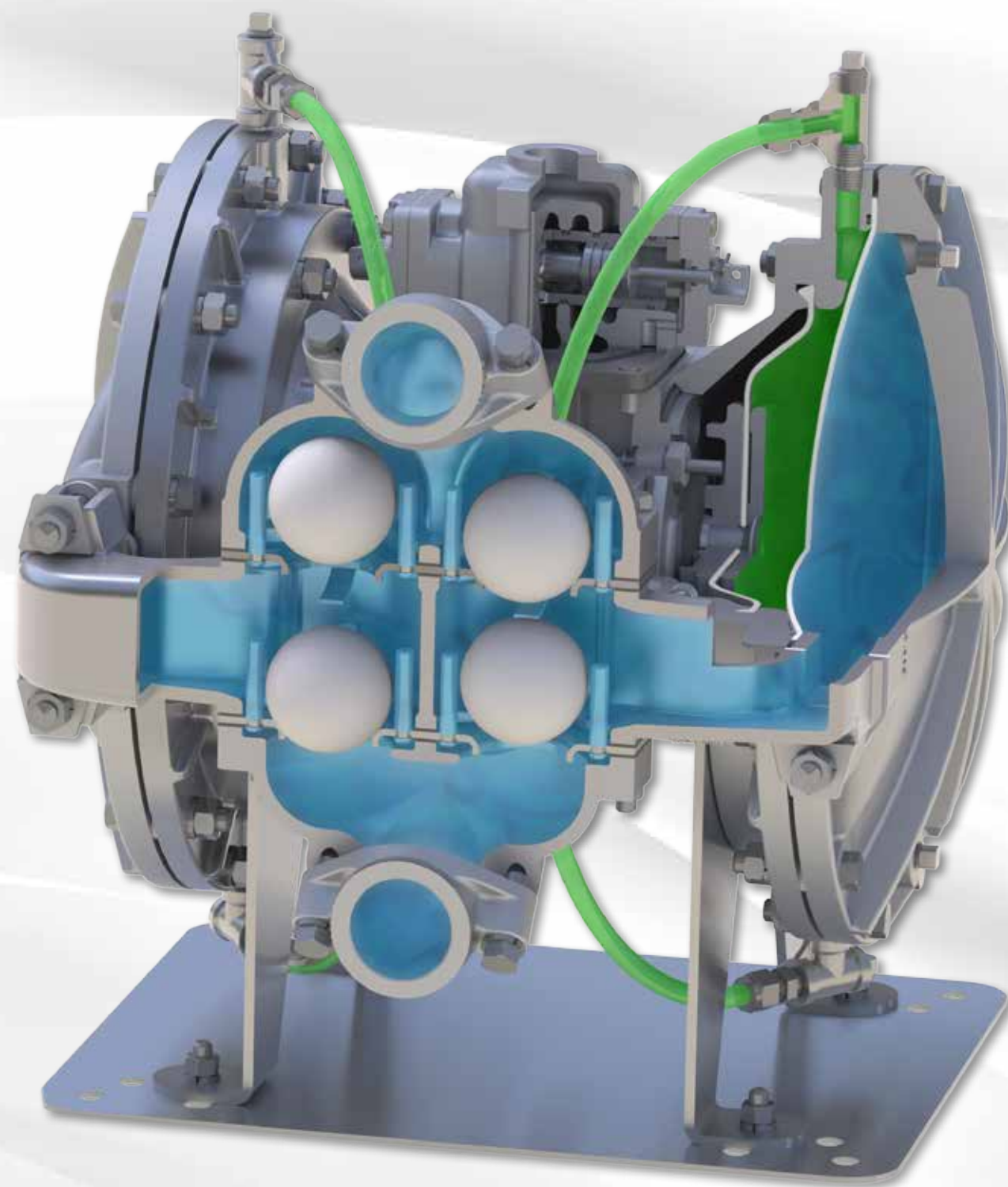

**All Bolted Construction**  
Durable and high pressure capable



**Top Discharge**  
For pumping out of tough areas



**Diaphragm Connecting Rods**  
Reliable and consistent diaphragm control



**Ball Check Valves**  
Provides powerful, high flow pumping



**ESADS+Plus Air Valve**  
Externally Serviceable Air Distribution System



**Dynamic Manifold Connections**  
90° - 180° rotation options



**Certifications Available**



PUMP CHARACTERISTICS		Non-Metallic	
Fluid Characteristics	Water	+	
	Suspended Solids	✓	
	Non-Suspended Solids	X	
	Line Size Solids	X	
	Sludge / Slurry	!	
	High Viscosity (Flowable Fluids)	✓	
	Erosion / Abrasive Fluids	High	!
		Moderate	!
		Low	✓
	Corrosion	+	
Installation	Permanent	✓	
	Portable	+	
	Containment / Prevention	+	
	Flooded Suction	✓	
	Suction Lift	✓	
	Submerged	!	
Duty	Intermittent / On-Demand	+	
	Continuous	✓	

+ = Best Type    ✓ = Suitable    ! = Limitations    X = Not Recommended

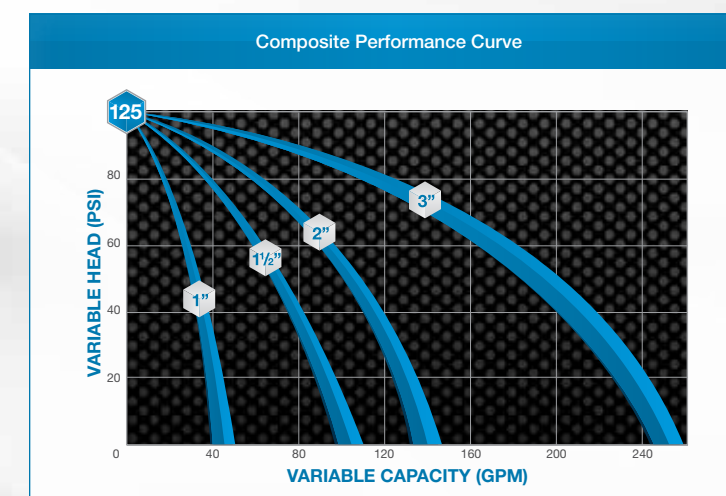

# CONTAINMENT DUTY BALL VALVE PUMPS

PERFORMANCE & SPECIFICATIONS

1"  
25mm

## ST1 / ST25 Metallic Performance



- MAX FLOW**  
• 42 GPM (159 LPM)
- PORTING**  
• NPT / BSP
- AIR END**  
• HDPE\*  
• Aluminum
- WET END**  
• Aluminum  
• Stainless Steel  
• Alloy C

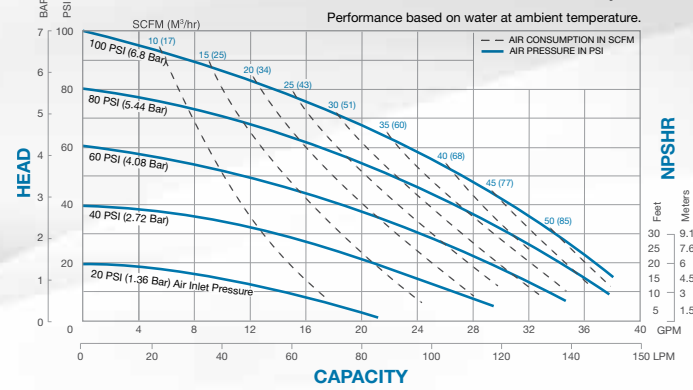

1 1/2"  
38mm

## ST1 1/2 / ST40 Metallic Performance



- MAX FLOW**  
• 106 GPM (401 LPM)
- PORTING**  
• NPT / BSP
- AIR END**  
• Cast Iron  
• Aluminum
- WET END**  
• Aluminum  
• Stainless Steel  
• Alloy C  
• Cast Iron

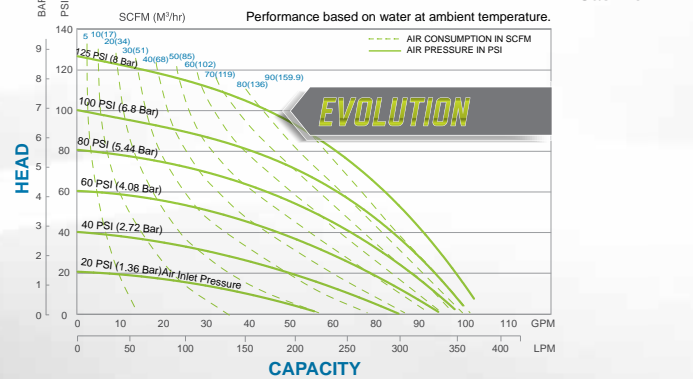

1"  
25mm

## S1F Non-Metallic Performance



- MAX FLOW**  
• 53 GPM (200 LPM)
- PORTING**  
• ANSI Flange  
• DIN Flange
- AIR END**  
• Polypropylene
- WET END**  
• Polypropylene  
• PVDF\*

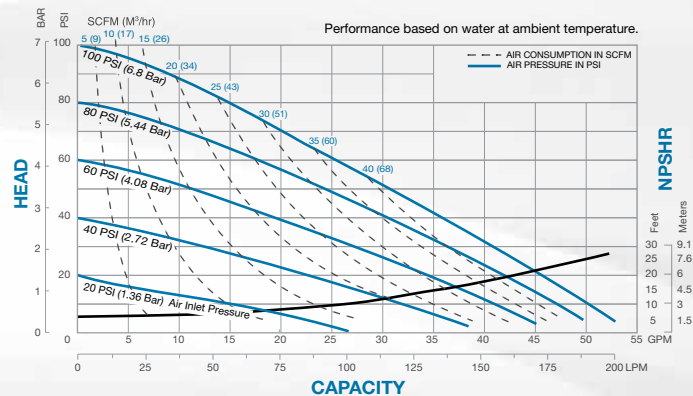

1 1/2"  
38mm

## S15 Non-Metallic Performance



- MAX FLOW**  
• 100 GPM (378 LPM)
- PORTING**  
• ANSI Flange  
• DIN Flange
- AIR END**  
• Polypropylene
- WET END**  
• PVDF  
• Polypropylene

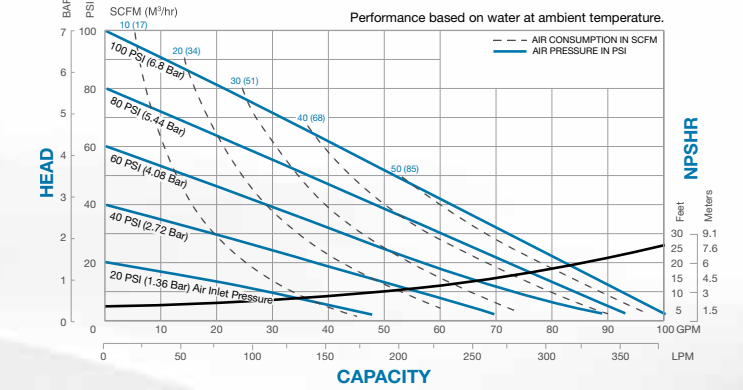

2"  
50mm

## S20 Non-Metallic Performance



- MAX FLOW**  
• 160 GPM (605 LPM)
- PORTING**  
• Universal Flange
- AIR END**  
• Polypropylene
- WET END**  
• Polypropylene  
• PVDF

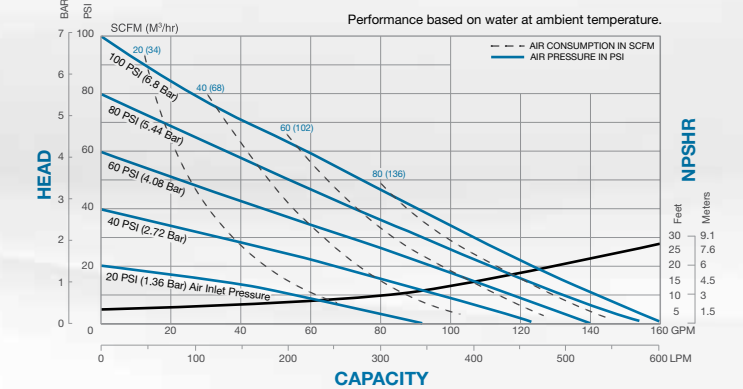

3"  
75mm

## S30 Non-Metallic Performance



- MAX FLOW**  
• 280 GPM (1,061 LPM)
- PORTING**  
• ANSI Flange  
• DIN Flange
- AIR END**  
• Glass Filled Polypropylene
- WET END**  
• Polypropylene  
• PVDF

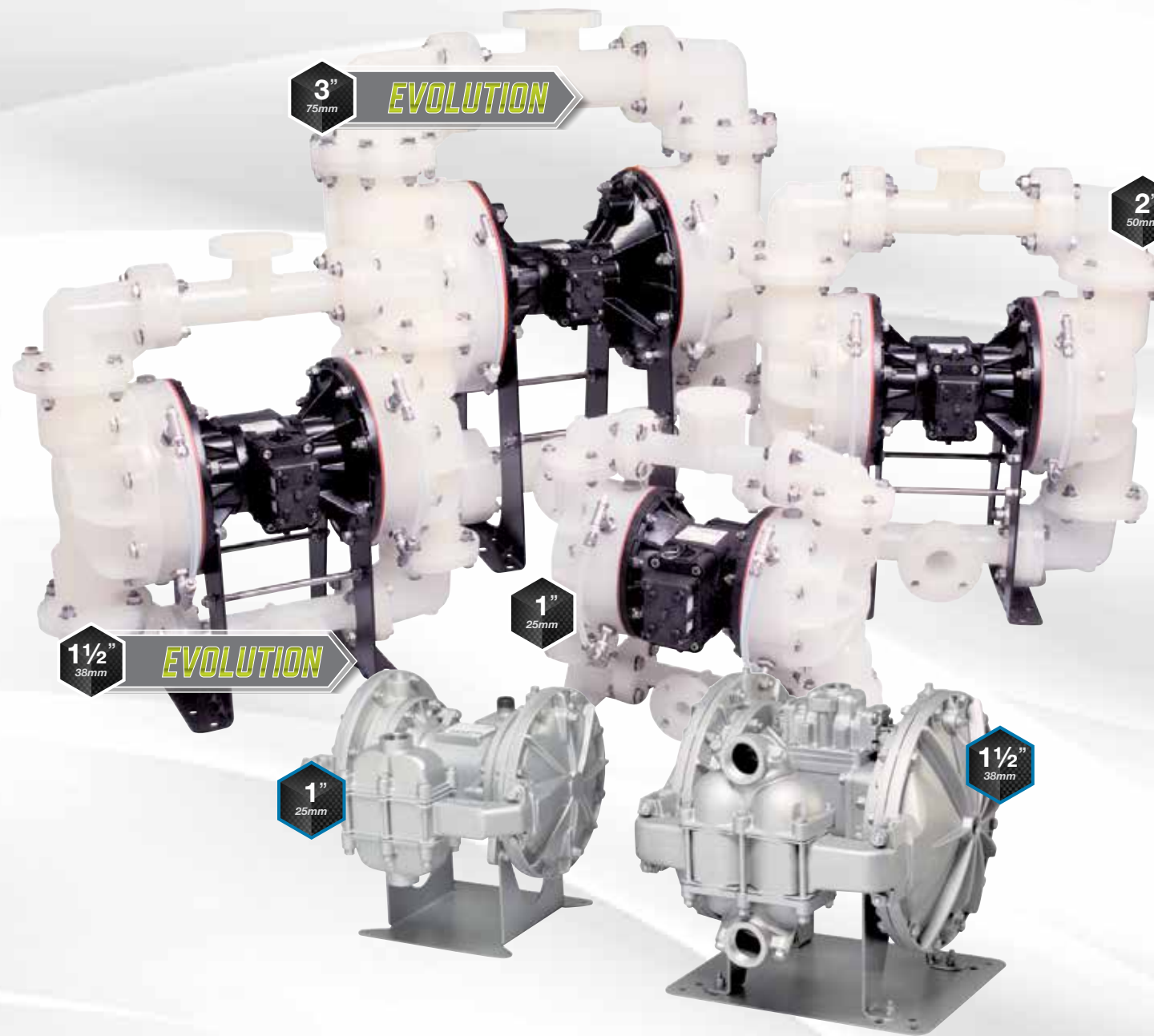
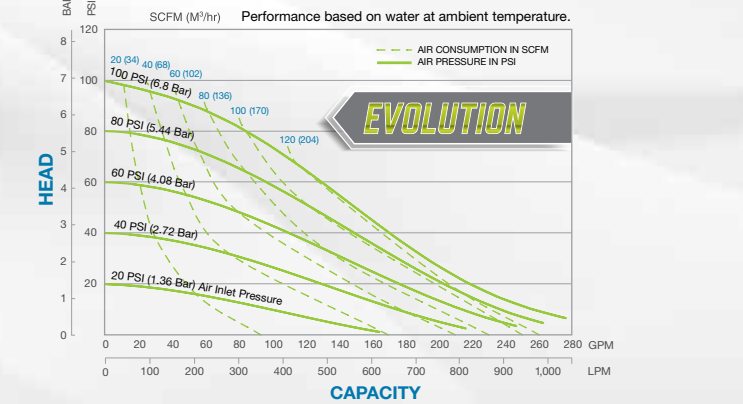

## Genuine Parts Service Videos

We make it easy for you to repair your pump with detailed service videos that teach you how to maintain your SANDPIPER pump right, from the advice of our experienced and certified support team.

LEARN MORE AT [SANDPIPERPUMP.COM/VIDEOS](http://SANDPIPERPUMP.COM/VIDEOS)



\*Conductive versions of this material are available.

# STANDARD DUTY BALL VALVE PUMPS

OFFERING THE WIDEST RANGE OF PERFORMANCE AND APPLICATION CAPABILITIES

Standard Duty Metallic Pumps are ideally suited for intermittent / on-demand, portable, moderately abrasive fluids, and suspended solids. Standard duty pumps are constructed in Aluminum, Cast Iron, Stainless Steel and non-metallic materials such as PTFE, Polypropylene, and PVDF with elastomer TPE (thermal plastic elastomers) and PTFE options in diaphragms and check valves.



## Lightweight & Portable

Weights as low as 4 lbs (1.8 kg)



## All Bolted Construction

Durable and high pressure capable



## Top Discharge

For pumping out of tough areas



## Ball Check Valves

Provide powerful, high flow pumping



## Diaphragm Connecting Rods

Reliable and consistent diaphragm control



## ESADS+Plus Air Valve

Externally Serviceable Air Distribution System



## Dynamic Manifold Connections

90° - 180° rotation options



## Certifications Available

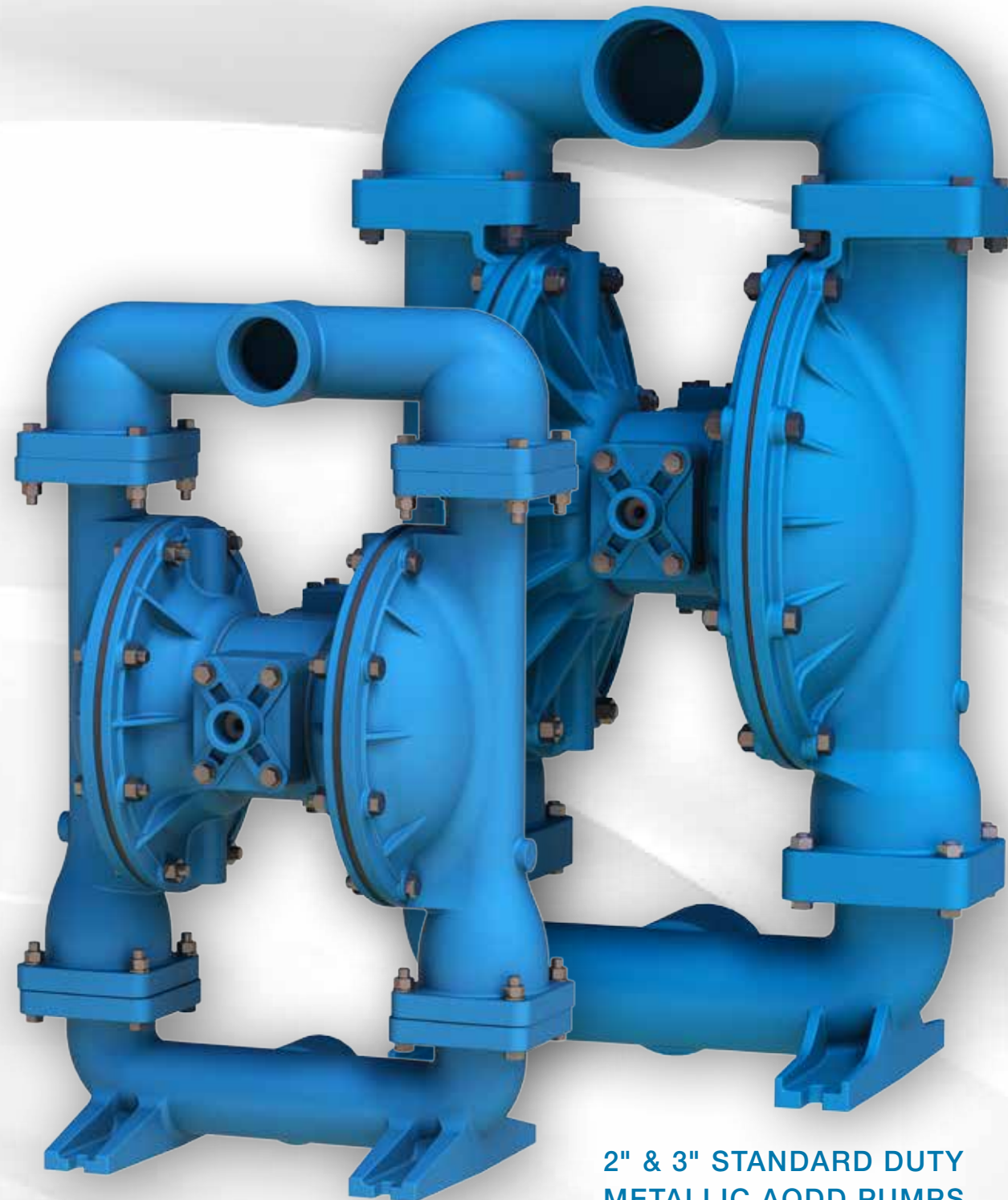

2" & 3" STANDARD DUTY METALLIC AODD PUMPS

CHARACTERISTICS		Metallic	Non-Metallic	
Fluid Characteristics	Water	+	+	
	Suspended Solids	+	✓	
	Non-Suspended Solids	!	X	
	Line Size Solids	X	X	
	Sludge / Slurry	✓	!	
	High Viscosity (Flowable Fluids)	✓	✓	
	Erosion / Abrasive Fluids	High	✓	!
		Moderate	✓	!
		Low	+	✓
	Corrosion	✓	+	
Installation	Permanent	✓	✓	
	Portable	+	+	
	Containment / Prevention	!	!	
	Flooded Suction	✓	✓	
	Suction Lift	✓	✓	
	Submerged	✓	!	
Duty	Intermittent / On-Demand	+	+	
	Continuous	✓	✓	

+ = Best Type   ✓ = Suitable   ! = Limitations   X = Not Recommended

What is

**EVOLUTION** ?

OPTIMIZED PERFORMANCE |

**Optimized performance** without sacrificing **proven reliability**. These pumps have undergone an engineering **EVOLUTION**, leveraging trusted and proven product designs to **improve their performance** by application of advanced engineering methods. Unlike the competition, these pumps are **fully interchangeable** with prior models.

Check out the **S20 & S30 Metallic updates** on page 39. Watch for **more Engineering Evolutions** to come in the near future!

# STANDARD DUTY BALL VALVE PUMPS

PERFORMANCE & SPECIFICATIONS

1/4"  
6mm

## E02 / X02 Metallic Performance



- MAX FLOW** • 4.75 GPM (18 LPM)
- PORTING** • BSP Parallel
- AIR END** • Stainless Steel
- WET END** • Stainless Steel

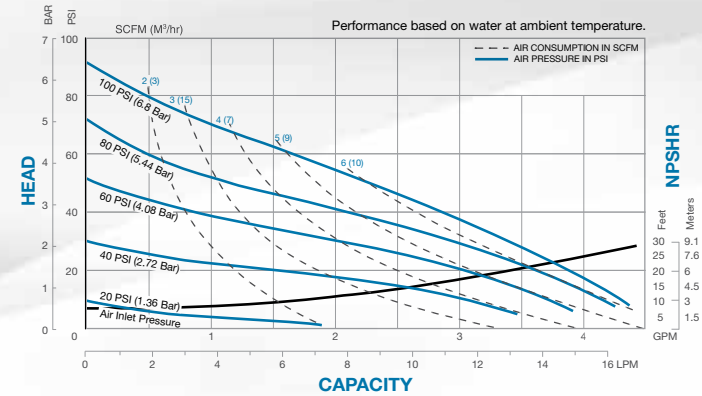

1/2"  
12mm

## S05 Metallic Performance



- MAX FLOW** • 15 GPM (57 LPM)
- PORTING** • NPT / BSP  
• ANSI Flange
- AIR END** • Aluminum
- WET END** • Aluminum  
• Stainless Steel

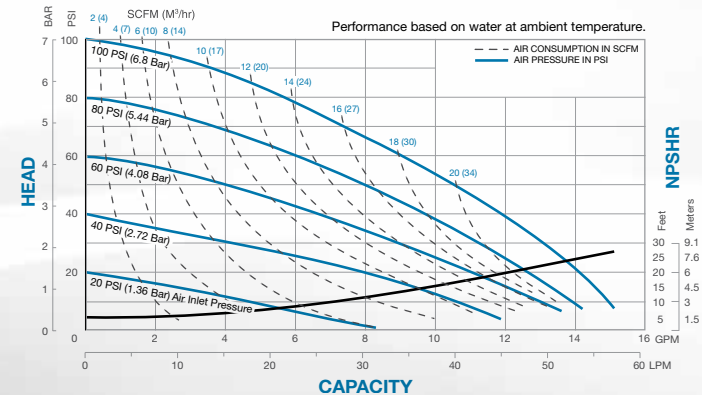

1"  
25mm

## S1F Metallic Performance



- MAX FLOW** • 45 GPM (170 LPM)
- PORTING** • NPT / BSP  
• ANSI Flange
- AIR END** • Aluminum
- WET END** • Cast Iron  
• Aluminum  
• Stainless Steel

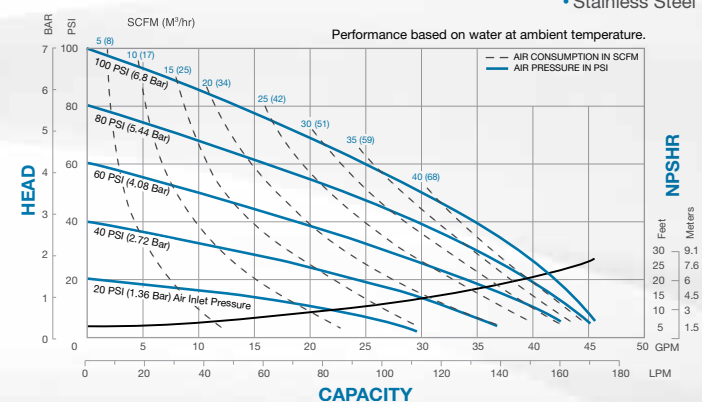

1 1/2"  
38mm

## S15 Metallic Performance



- MAX FLOW** • 106 GPM (401 LPM)
- PORTING** • NPT / BSP  
• ANSI Flange
- AIR END** • Aluminum
- WET END** • Cast Iron  
• Aluminum  
• Stainless Steel

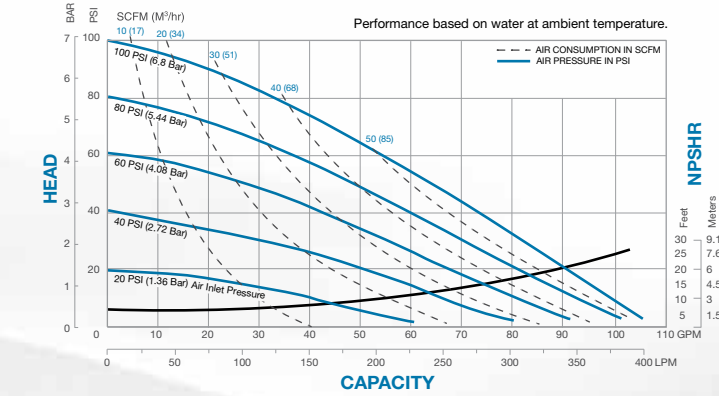

2"  
50mm

## S20 Metallic Performance



- MAX FLOW** • 198 GPM (750 LPM)
- PORTING** • NPT / BSP  
• ANSI / DIN Flange
- AIR END** • Aluminum
- WET END** • Aluminum  
• Stainless Steel  
• Cast Iron

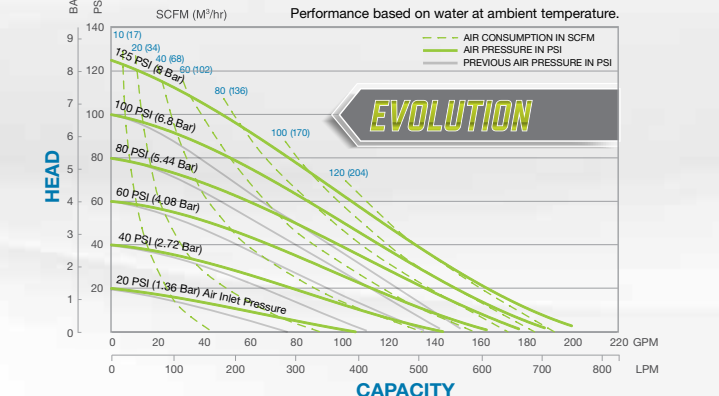

3"  
75mm

## S30 Metallic Performance



- MAX FLOW** • 285 GPM (1,078 LPM)
- PORTING** • NPT / BSP  
• ANSI / DIN Flange
- AIR END** • Aluminum
- WET END** • Aluminum  
• Stainless Steel  
• Cast Iron

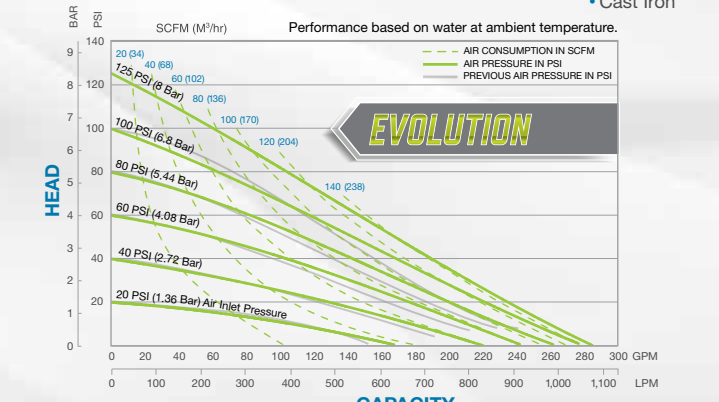

### Genuine Parts Service Kits

- Everything in One Place.
- Increase Uptime.
- Reduce Frequency of Repairs.
- Save Time and Money.

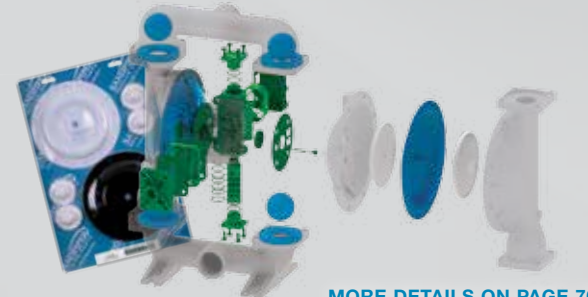

MORE DETAILS ON PAGE 70

# STANDARD DUTY BALL VALVE PUMPS

PERFORMANCE & SPECIFICATIONS

## 1/4" Non-Metallic Performance

- MAX FLOW** • 4 GPM (15 LPM)  
**PORTING** • NPT  
**AIR END** • Polypropylene  
 • Conductive Acetal  
**WET END** • Polypropylene  
 • PVDF  
 • Conductive Acetal

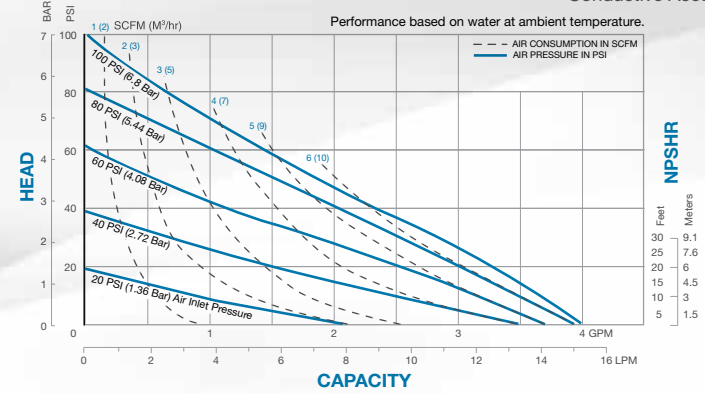

## 3/8" Non-Metallic Performance

- MAX FLOW** • 6.8 GPM (26 LPM)  
**PORTING** • NPT / BSP  
**AIR END** • PTFE  
**WET END** • PTFE  
 • PVDF

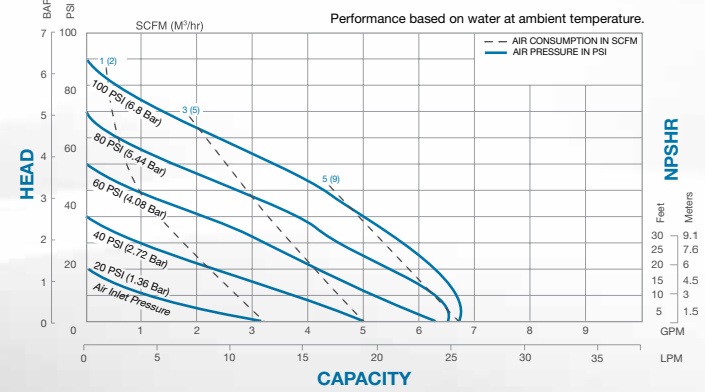

## 1/2" Non-Metallic Performance

- MAX FLOW** • 14 GPM (52 LPM)  
**PORTING** • NPT / BSP  
**AIR END** • Polypropylene  
 • Conductive Polypropylene  
**WET END** • Polypropylene / Conductive Polypropylene  
 • Nylon  
 • PVDF / Conductive PVDF  
 • Conductive Acetal

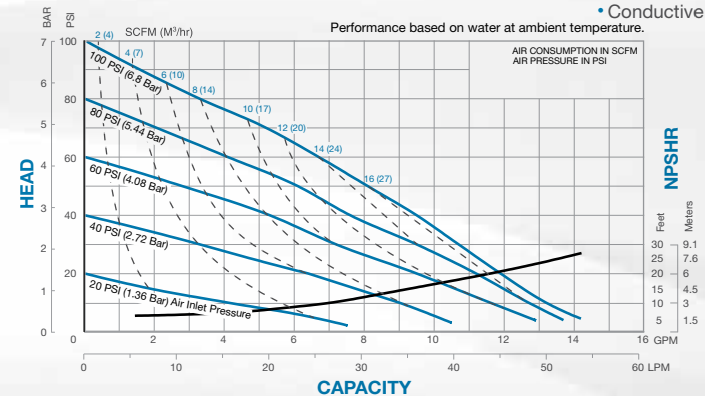

## 3/4" S07 Non-Metallic Performance

- MAX FLOW** • 23 GPM (87 LPM)  
**PORTING** • NPT / BSP  
**AIR END** • Polypropylene  
**WET END** • Polypropylene  
 • Nylon  
 • PVDF

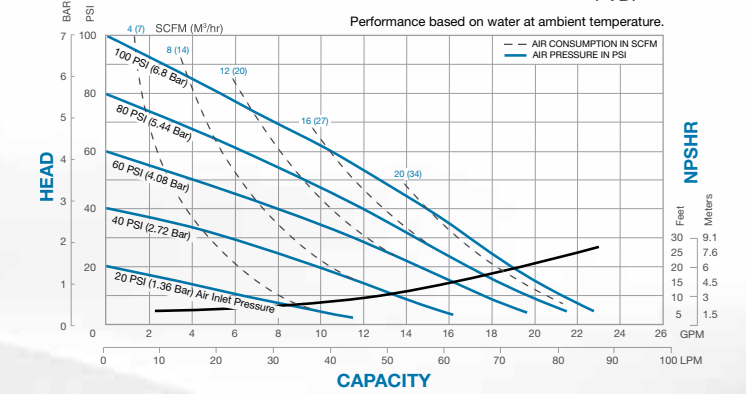

## 1" S10 Non-Metallic Performance

- MAX FLOW** • 23 GPM (87 LPM)  
**PORTING** • ANSI Flange  
**AIR END** • Polypropylene  
**WET END** • Polypropylene  
 • Nylon  
 • PVDF

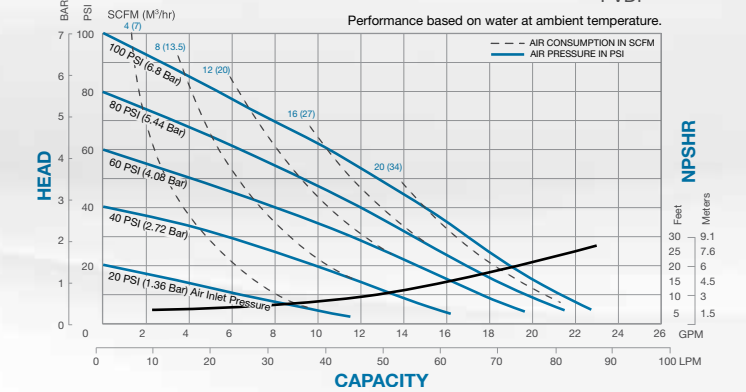

## 1" S1F Non-Metallic Performance

- MAX FLOW** • 53 GPM (200 LPM)  
**PORTING** • ANSI Flange  
 • DIN Flange  
 • NPT  
**AIR END** • Polypropylene  
 • 40% Glass Filled Polypropylene  
 • Conductive Polypropylene  
**WET END** • Polypropylene  
 • PVDF  
 • Conductive Polypropylene  
 • Conductive PVDF

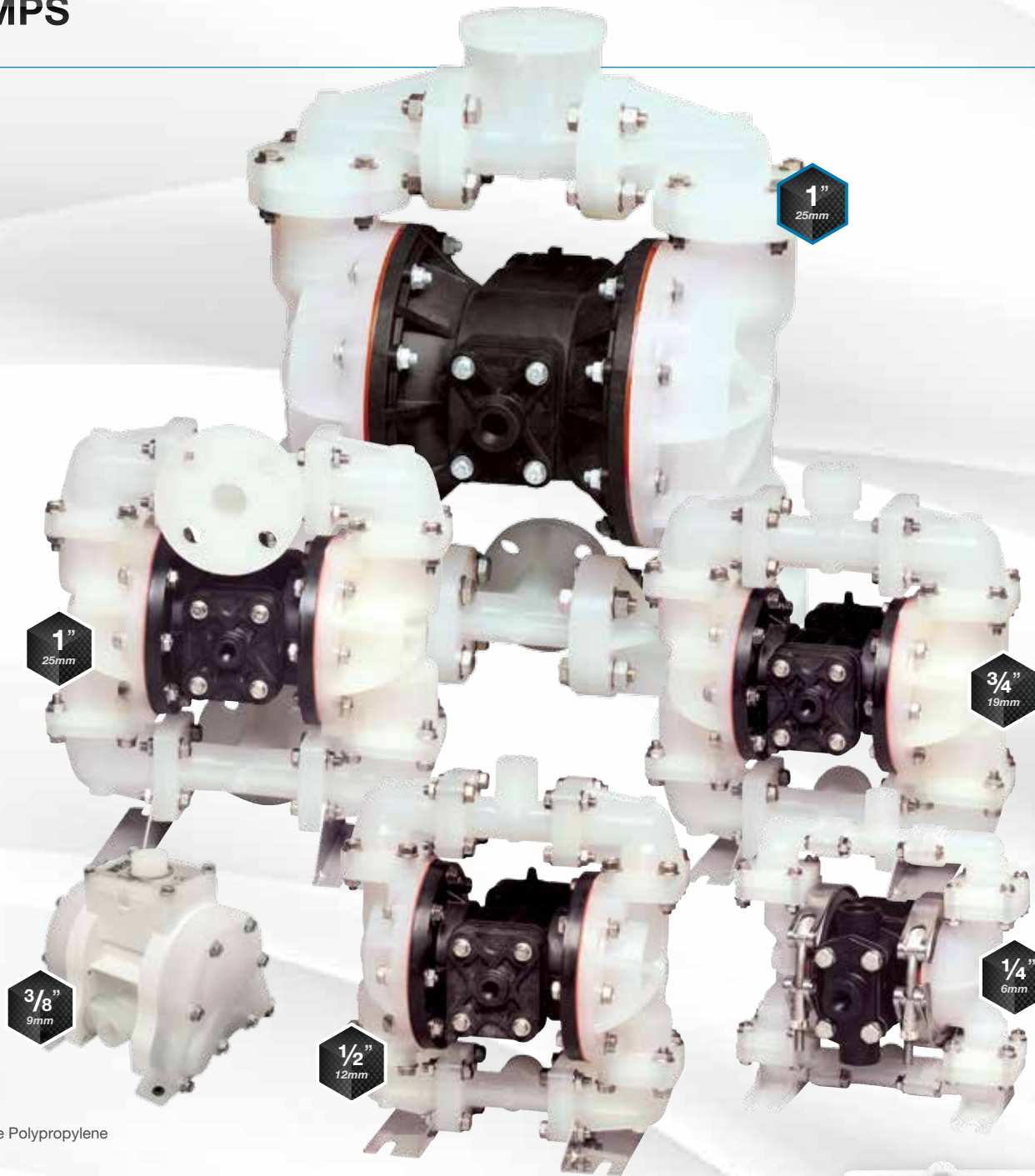
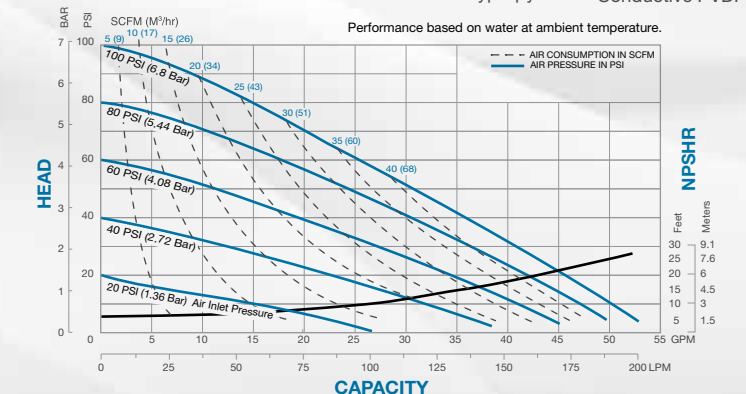

### SANDPIPER Mobile App

The SANDPIPER Mobile App can save you time and money by allowing you to track your pump maintenance, submit quotes for kit purchasing and have instant access to many other tools and resources.

[LEARN MORE AT SANDPIPERPUMP.COM/MOBILEAPP](http://SANDPIPERPUMP.COM/MOBILEAPP)

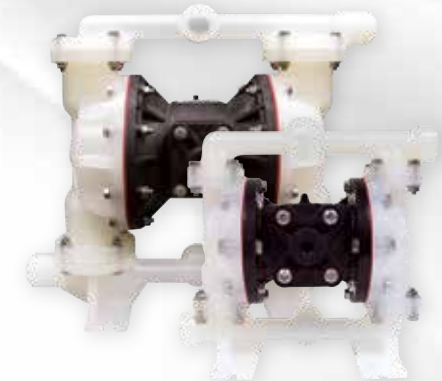

In-line ported options also available on S05 and S1F

# STANDARD DUTY BALL VALVE PUMPS

PERFORMANCE & SPECIFICATIONS

1 1/2"  
38mm

## S15 Non-Metallic Performance



- MAX FLOW**  
• 100 GPM (378 LPM)
- PORTING**  
• ANSI Flange  
• DIN Flange
- AIR END**  
• Polypropylene  
• Conductive Polypropylene
- WET END**  
• Polypropylene  
• PVDF  
• Conductive Polypropylene

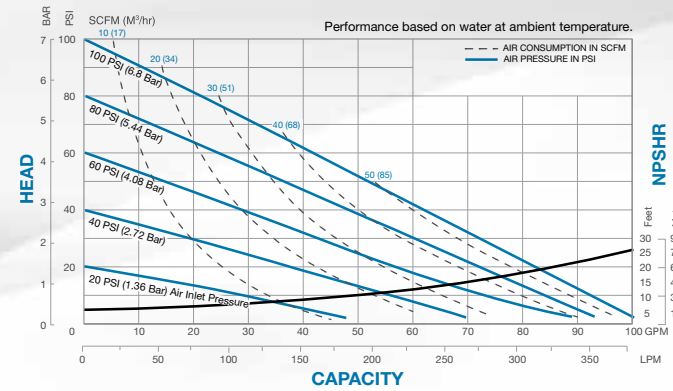

2"  
50mm

## S20 Non-Metallic Performance



- MAX FLOW**  
• 160 GPM (605 LPM)
- PORTING**  
• Universal Flange
- AIR END**  
• Polypropylene  
• Conductive Polypropylene
- WET END**  
• Polypropylene  
• PVDF  
• Conductive Polypropylene

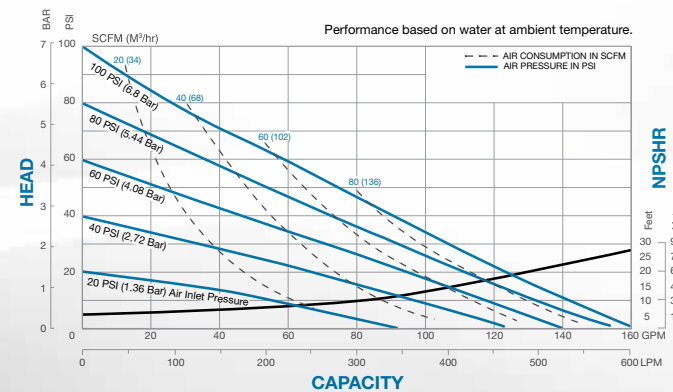

3"  
75mm

## S30 Non-Metallic Performance



- MAX FLOW**  
• 280 GPM (1,061 LPM)
- PORTING**  
• ANSI Flange  
• DIN Flange
- AIR END**  
• Glass Filled Polypropylene
- WET END**  
• Polypropylene  
• PVDF

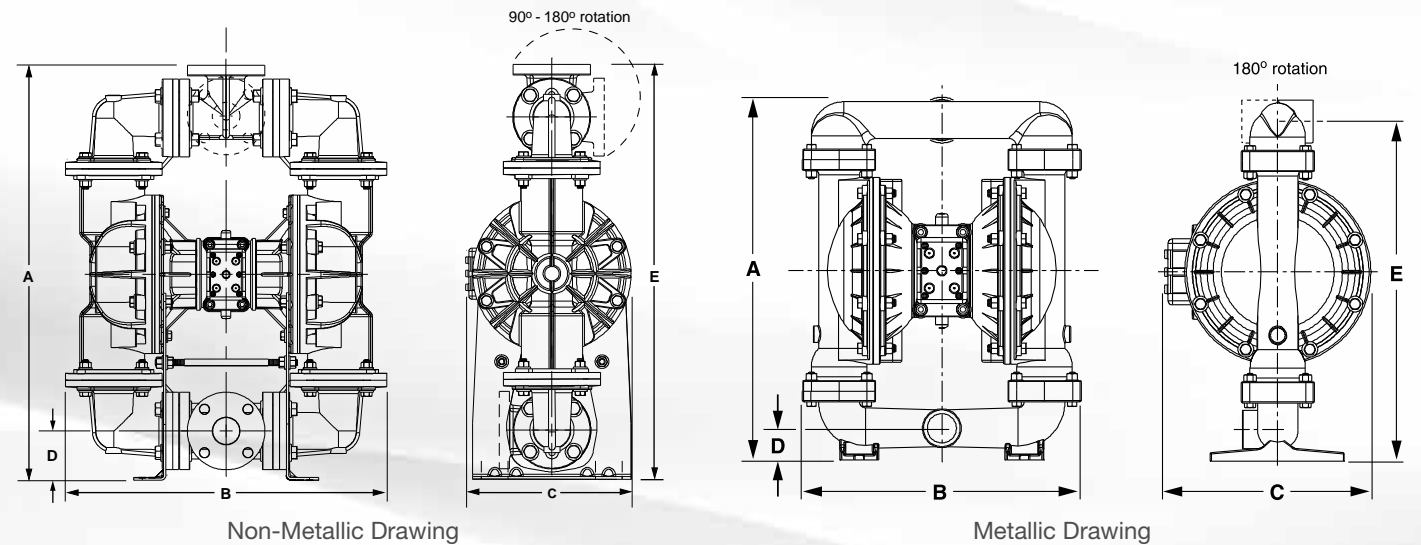
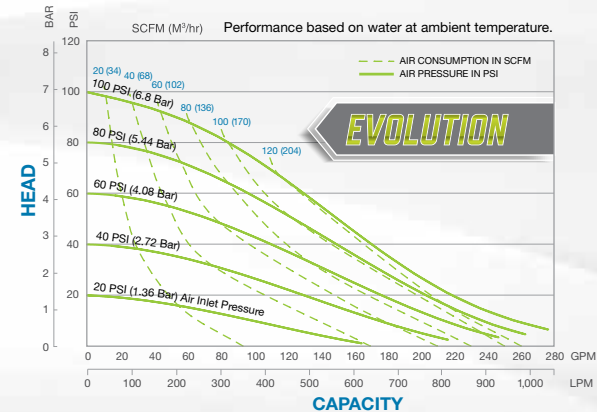

### METALLIC SPECIFICATIONS

PUMP MODELS	A	B	C	E		Connection Style	Pipe Size	Displacement Per Stroke	Max Flow Per Minute	Max Solids Handling	Max Discharge Pressure
	Height	Width	Depth	Bottom of Base to Suction	Center Line of Discharge						
	inches (mm)	inches (mm)	inches (mm)	inches (mm)	inches (mm)		inch (mm)	gal (liter)	gal (liter)	inch (mm)	psi (bar)
E02 / X02	5.81 (148)	7.44 (189)	4.38 (111)	.63(16)	5.41 (138)	1/4" NPT/BSP	.25 (6)	.003 (.01)	4.75 (18)	.08 (2)	125 (8.6)
S05 AL	11.5 (292)	10.25 (260)	7.44 (179)	1.94 (33)	11.5 (292)	1/2" NPT/BSP	.5 (12)	.026 (.098)	15 (57)	.13 (3)	125 (8.6)
S05 SS	10.38 (264)	10.25 (260)	7.44 (179)	1.31 (33)	9.72 (247)	1/2" NPT/BSP	.5 (12)	.026 (.098)	15 (57)	.13 (3)	125 (8.6)
S1F AL / CI	12.72 (323)	10.25 (260)	10.38 (264)	1.09 (28)	11.84 (301)	1" NPT/BSP	1 (25)	.11 (.42)	45 (170)	.25 (6)	125 (8.6)
S1F SS	12.84 (326)	10.25 (260)	10.38 (264)	1.22 (31)	11.97 (304)	1" NPT/BSP	1 (25)	.11 (.42)	45 (170)	.25 (6)	125 (8.6)
S15 AL / CI	21.58 (548)	16.66 (423)	12.36 (314)	1.91 (49)	20.31 (516)	1 1/2" NPT/BSP	1.5 (38)	.41 (1.55)	106 (401)	.25 (6)	125 (8.6)
S15 SS	21.66 (550)	16.66 (423)	12.36 (314)	1.97 (50)	20.38 (518)	1 1/2" NPT/BSP	1.5 (38)	.41 (1.55)	106 (401)	.25 (6)	125 (8.6)
S20 AL / CI	26.31 (669)	16.88 (428)	12.59 (320)	1.88 (48)	24.63 (625)	2" NPT/BSP	2 (50)	.42 (1.59)	198 (750)	.25 (6)	125 (8.6)
S20 SS	26.31 (669)	16.88 (428)	12.59 (320)	2 (50)	24.75 (629)	2" NPT/BSP	2 (50)	.42 (1.59)	198 (750)	.25 (6)	125 (8.6)
S30 AL/CI	32.06 (814)	19.66 (499)	15.75 (400)	2.34 (60)	29.97 (761)	3" NPT/BSP	3 (75)	.94 (3.56)	285 (1,078)	.38 (9.5)	125 (8.6)
S30 SS	32.28 (820)	19.66 (499)	15.75 (400)	2.28 (65)	30.19 (767)	3" NPT/BSP	3 (75)	.94 (3.56)	285 (1,078)	.38 (9.5)	125 (8.6)

Dimensional Tolerance: ±1/8" (±3mm) • See service manual for complete specifications.

### NON-METALLIC SPECIFICATIONS

PUMP MODELS	A	B	C	E		Connection Style	Pipe Size	Displacement Per Stroke	Max Flow Per Minute	Max Solids Handling	Max Discharge Pressure
	Height	Width	Depth	Bottom of Base to Suction	Center Line of Discharge						
	inches (mm)	inches (mm)	inches (mm)	inches (mm)	inches (mm)		inch (mm)	gal (liter)	gal (liter)	inch (mm)	psi (bar)
PB1/4	7.81 (198)	7 (178)	5.5 (140)	.75 (19)	7.81 (198)	1/4" NPT	.25 (6)	.01 (.04)	4 (15)	.03 (1)	100 (6.9)
WR10	5.32 (135)	4.09 (104)	5.72 (145)	0.94 (24)	0.94 (24)	3/8" NPT	.375 (10)	.009 (.034)	6.8 (26)	0.1 (2.25)	100 (6.9)
S05	11.31 (287)	10.13 (257)	7.06 (179)	1.38 (35)	11.31 (287)	1/2" NPT	.5 (13)	.026 (.098)	14 (52)	.125 (3)	100 (6.9)
S07T*	13.34 (339)	11.81 (300)	7.06 (179)	1.81 (46)	13.34 (339)	3/4" NPT	.75 (19)	.026 (.098)	13 (48)	.38 (9)	100 (6.9)
S07	13.34 (339)	11.81 (300)	7.06 (179)	1.81 (46)	13.34 (339)	3/4" NPT	.75 (19)	.026 (.098)	23 (87)	.15 (4)	100 (6.9)
S10	13.81 (351)	11.81 (300)	7.56 (192)	2.5 (64)	11.69 (297)	1" ANSI	1 (25)	.026 (.098)	23 (87)	.15 (4)	100 (6.9)
S1F	21 (533)	17 (433)	11.63 (295)	2.5 (64)	21 (533)	1" U	1 (25)	.19 (.72)	53 (200)	.25 (6)	100 (6.9)
S15	28.75 (730)	23 (584)	13 (330)	3.5 (89)	25.19 (640)	1 1/2" ANSI or DIN	1.5 (38)	.36 (1.36)	100 (378)	.47 (12)	100 (6.9)
S20	32.25 (819)	23.81 (605)	13 (330)	3.81 (97)	28.19 (716)	2" U	2 (50)	.36 (1.36)	160 (605)	.66 (17)	100 (6.9)
S30	40.66 (1033)	32.31 (821)	16.19 (411)	4.85 (123)	40.66 (1033)	3" ANSI or DIN	3 (75)	1.0 (3.78)	280 (1061)	.75 (19)	100 (6.9)

Dimensional Tolerance: ±1/8" (±3mm) • See service manual for complete specifications.

U = Universal: Fits both ANSI or DIN.  
\*T = Trihedral.

# SPECIAL DUTY PUMPS

THE SAME QUALITY SANDPIPER PRODUCTS DESIGNED TO FIT SPECIFIC NEEDS

PAGE  
46

## NATURAL GAS PUMPS

CSA certified to ANSI LC6 standard and Canadian Technical Letter No. R-14 for operation using sweet or sour natural gas

PAGE  
50

## UL LISTED PUMPS



Designed to meet UL79 standards for diaphragm pumps handling flammable liquids

PAGE  
51

## SUBMERSIBLE CENTRIFUGAL PUMPS

Lightweight and powerful pumps great for high flow and close quarters pumping situations

PAGE  
52

## PREMIUM FDA COMPLIANT PUMPS

Regulation 1935/2004/EC Compliant and the ultimate in leak protection and clean pumping with the paired performance of AODD technology

PAGE  
54

## FDA COMPLIANT PUMPS

Regulation 1935/2004/EC Compliant and ideally suited for a variety of food processing, pharmaceutical and cosmetic industry applications

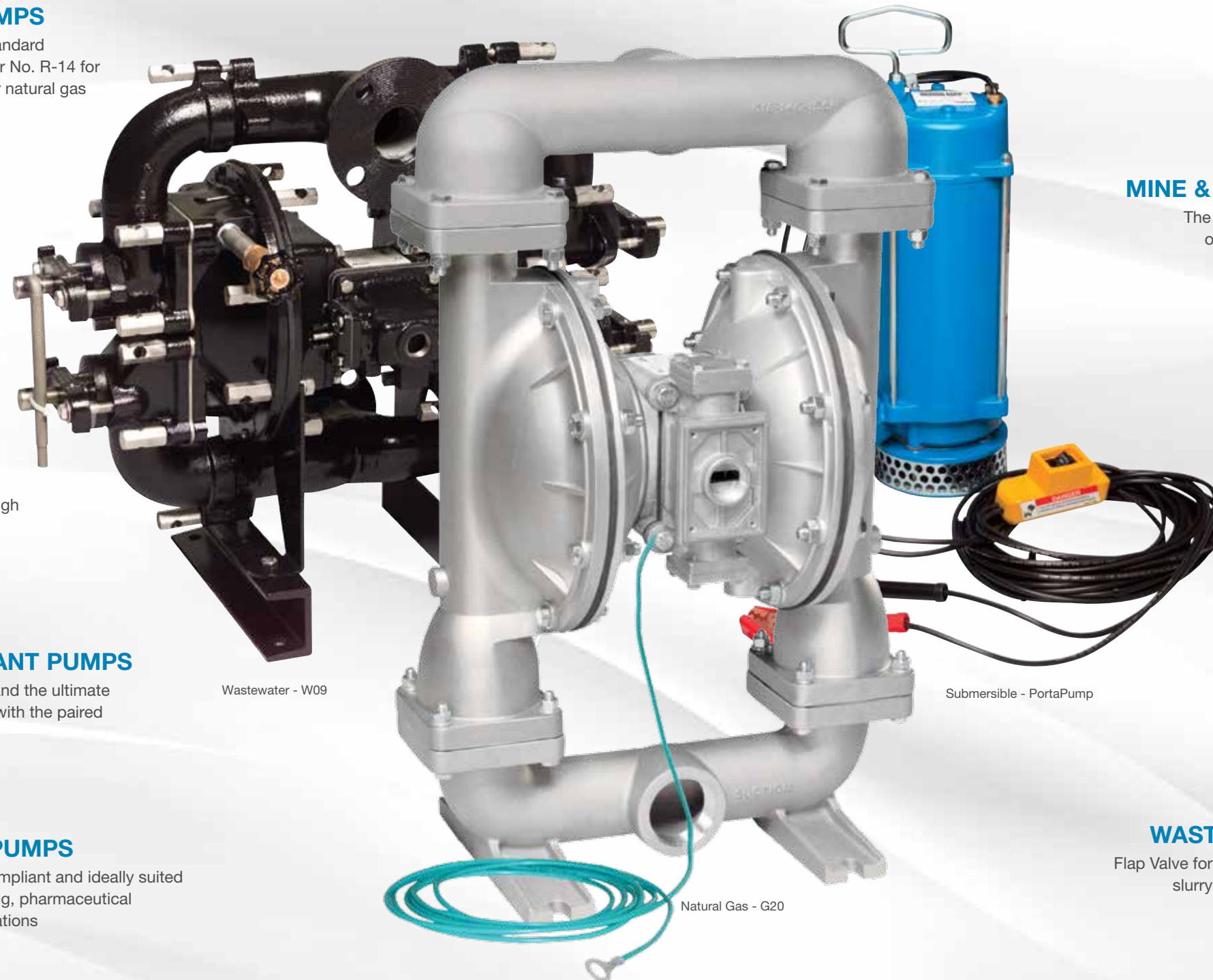

Wastewater - W09

Submersible - PortaPump

Natural Gas - G20

## MINE & CONSTRUCTION PUMPS

The most durable and reliable pump line we offer, for the best quality at your next site

PAGE  
56

## HIGH PRESSURE PUMPS

Deliver discharge pressure twice the inlet pressure, up to 250 PSI (17 BAR)

PAGE  
58

## FILTER PRESS SYSTEMS

Combine a high volume fill pump with a high pressure feed pump

PAGE  
60

## WASTEWATER PUMPS

Flap Valve for superior performance with slurry and solids-laden materials

PAGE  
61

# DUAL POWER NATURAL GAS OR AIR OPERATED PUMPS

CSA CERTIFIED

FLAP VALVE PUMPS

## 1" 25mm G10F Metallic Performance

- MAX FLOW**  
• 70 GPM (265 LPM)
- PORTING**  
• NPT / BSP (tapered)
- GAS / AIR END**  
• Aluminum  
• Nitrile or FKM Elastomers
- WET END**  
• Aluminum  
• Stainless Steel  
• Nitrile or FKM Diaphragm / Check Valves
- MAX SOLIDS**  
• 1" (25mm)

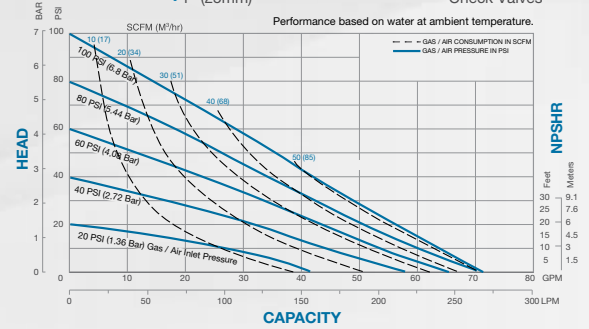

## 2" 50mm G20F Metallic Performance

- MAX FLOW**  
• 208 GPM (787 LPM)
- PORTING**  
• NPT
- GAS / AIR END**  
• Aluminum  
• Nitrile or FKM Elastomers
- WET END**  
• Aluminum  
• Stainless Steel  
• Nitrile or FKM Diaphragm / Check Valves
- MAX SOLIDS**  
• 2" (50mm)

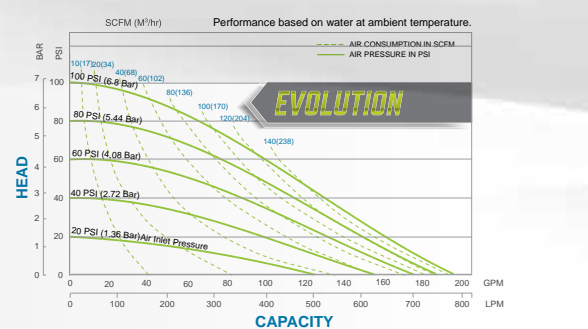

## 1/2" 12mm G05 Metallic Performance

- MAX FLOW**  
• 15 GPM (57 LPM)
- PORTING**  
• NPT / BSP (tapered)  
• ANSI Flange\*
- GAS / AIR END**  
• Aluminum  
• Nitrile or FKM Elastomers
- WET END**  
• Aluminum  
• Stainless Steel  
• Nitrile or PTFE Diaphragm / Check Valves

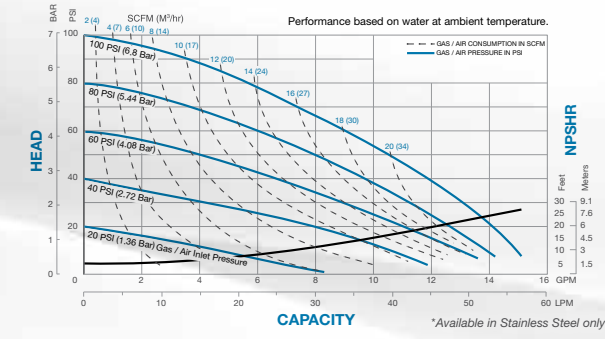

## 1" 25mm G1F Metallic Performance

- MAX FLOW**  
• 45 GPM (170 LPM)
- PORTING**  
• NPT / BSP (tapered)  
• ANSI Flange
- GAS / AIR END**  
• Aluminum  
• Nitrile or FKM Elastomers
- WET END**  
• Aluminum  
• Stainless Steel  
• Nitrile or PTFE Diaphragm / Check Valves

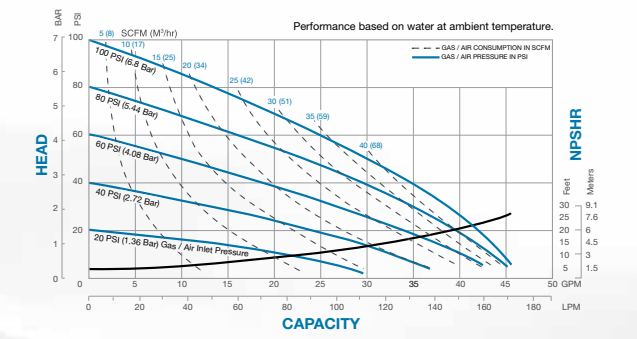

**Remote Site Serviceability**  
ESADS+Plus Air / Gas System allows for an on-site maintenance time of only 5 minutes

**Hydrostatic Strength Test**  
500 PSI (34.5 BAR)

**Temperature Limits**  
-10°F (-23°C) to 180°F (82°C)

**Nitrile or FKM Elastomers**  
Air / Gas End options for varying temperatures and chemical compatibility

## 1 1/2" 38mm G15 Metallic Performance

- MAX FLOW**  
• 106 GPM (401 LPM)
- PORTING**  
• NPT / BSP (tapered)  
• ANSI Flange
- GAS / AIR END**  
• Aluminum  
• Stainless Steel  
• Nitrile or FKM Elastomers
- WET END**  
• Aluminum  
• Stainless Steel  
• Nitrile or PTFE Diaphragm / Check Valves

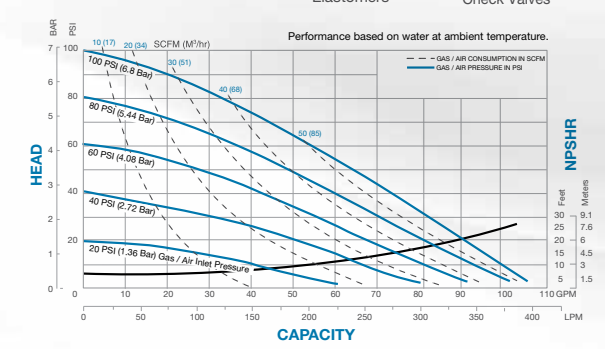

## 2" 50mm G20 Metallic Performance

- MAX FLOW**  
• 198 GPM (750 LPM)
- PORTING**  
• NPT / BSP (tapered)  
• ANSI Flange
- GAS / AIR END**  
• Aluminum  
• Stainless Steel  
• Nitrile or FKM Elastomers
- WET END**  
• Aluminum  
• Stainless Steel  
• Nitrile or PTFE Diaphragm / Check Valves

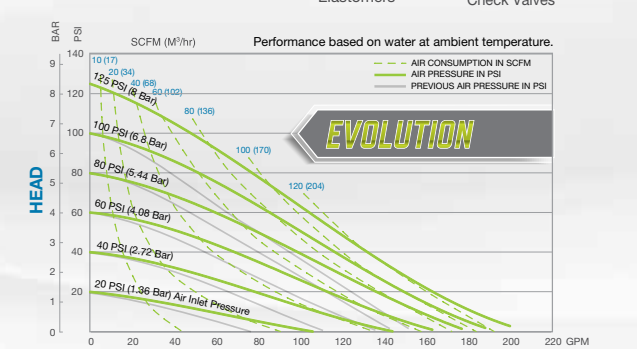

## 3" 75mm G30 Metallic Performance

- MAX FLOW**  
• 285 GPM (1,078 LPM)
- PORTING**  
• NPT / BSP (tapered)  
• ANSI Flange  
• DIN Flange
- GAS / AIR END**  
• Aluminum  
• Stainless Steel  
• Nitrile or FKM Elastomers
- WET END**  
• Aluminum  
• Stainless Steel  
• Nitrile or PTFE Diaphragm / Check Valves

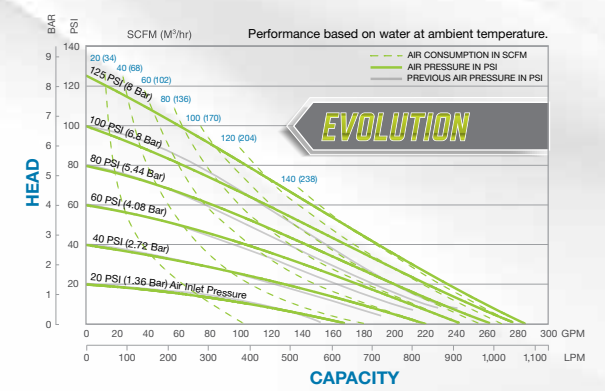

## SANDPIPER G-SERIES™



## DUAL POWER

DESIGNED & TESTED TO BE SAFELY POWERED BY COMPRESSED AIR OR NATURAL GAS

All SANDPIPER G-Series™ pumps feature *Dual Power* capabilities and may be safely powered by compressed air or natural gas depending on the application, which offers simplified purchasing, maintenance and training while reducing inventory.

CSA is the Canadian Standards Association, an international organization for testing products to ensure public safety, and the governing agency for the Natural Gas Industry.



# OIL & GAS INDUSTRY PUMPS

PERFORMANCE & SPECIFICATIONS



2"  
50mm

## DMF2 Metallic Performance



- MAX FLOW** • 140 GPM (530 LPM) | **PORTING** • NPT | **AIR END** • Aluminum • Nitrile Elastomers | **WET END** • Aluminum • Nitrile Diaphragm / Check Valves

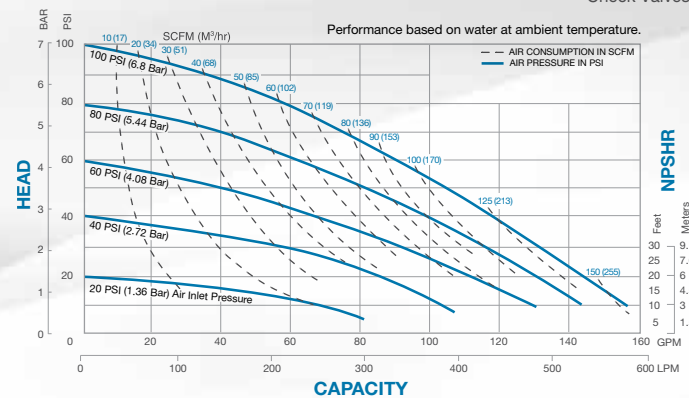

SANDPIPER Drillers Series pumps operate on compressed air and are designed for the toughest drilling applications. The durable roll cage and skid base configurations provide portability and pump protection. The flap check valve design allows passage of larger solids than traditional ball valve pumps and is ideal for your drilling applications. The exclusive bottom suction discharge porting arrangement provides superior suction lift and eliminates the damage from settling solids in your pump. This Heavy Duty pump features thick wall construction and is enhanced with an extended wear package.

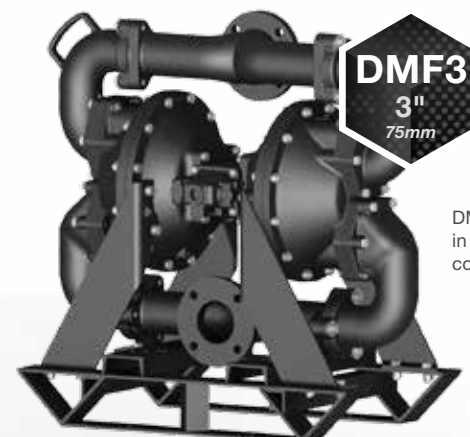

DMF3  
3"  
75mm

DMF3 is available in Skid Base configuration

3"  
75mm

## DMF3 Metallic Performance



- MAX FLOW** • 260 GPM (988 LPM) | **PORTING** • ANSI Flange | **AIR END** • Aluminum • Nitrile Elastomers | **WET END** • Aluminum • Nitrile Diaphragm / Check Valves

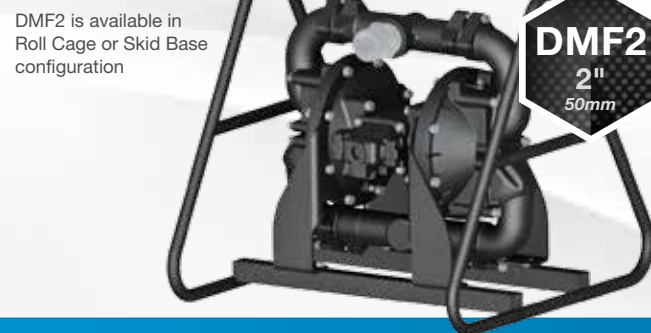
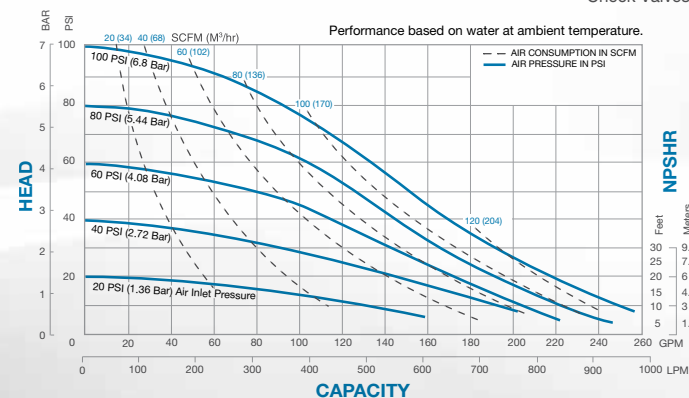

DMF2  
2"  
50mm

DMF2 is available in Roll Cage or Skid Base configuration

### SPECIFICATIONS

PUMP MODELS	A	B	C	D	E	Porting (Standard)	Pipe Size	Displacement Per Stroke	Max Flow Per Minute	Max Solids Handling	Max Fluid Discharge Pressure	Max Air/ Gas Inlet Pressure
	Height	Width	Depth	Bottom of Base to Center Line of Suction	Center Line Discharge							
	inches (mm)	inches (mm)	inches (mm)	inches (mm)	inches (mm)		inch (mm)	gal (liter)	gal (liter)	inch (mm)	psi (bar)	psi (bar)
G05	11.5 (292)	10.25 (260)	7.06 (179)	1.31 (33)	11.5 (292)	½" NPT / BSP	.5 (12)	.026 (.098)	15 (57)	.125 (3)	100 (7)	100 (7)
G1F	12.72 (323)	10.25 (260)	10.38 (264)	1.09 (28)	11.84 (301)	1" NPT / BSP	1 (25)	.11 (.42)	45 (170)	.25 (6)	100 (7)	100 (7)
G10F	15.69 (398)	16.75 (425)	10.81 (274)	14.06 (356)	2.56 (65)	1" NPT / BSP	1 (25)	.10 (.38)	70 (265)	1 (25)	100 (7)	100 (7)
G15	21.58 (548)	16.66 (423)	12.36 (314)	1.91 (49)	20.31 (516)	1½" NPT / BSP	1.5 (38)	.41 (4.55)	106 (401)	.25 (6)	100 (7)	100 (7)
G20F	20.31 (516)	21.75 (552)	13.63 (346)	17.69 (449)	2.56 (65)	2" NPT	2 (50)	.47 (1.78)	208 (787)	2 (50)	100 (7)	100 (7)
G20	26.31 (668)	16.88 (428)	12.59 (320)	1.88 (48)	24.63 (625)	2" NPT / BSP	2 (50)	.42 (1.59)	198 (750)	.25 (6)	100 (7)	100 (7)
G30	32.06 (814)	19.66 (499)	15.75 (400)	2.34 (60)	29.97 (761)	3" NPT / BSP	3 (75)	.94 (3.56)	285 (1,078)	.38 (9)	100 (7)	100 (7)
DMF2	26.04 (661)	32 (813)	18.5 (470)	8.73 (222)	23.85 (606)	2" NPT	2 (50)	.42 (1.59)	140 (530)	2 (50)	125 (8.6)	125 (8.6)
DMF3	34.09 (866)	36.72 (933)	18.5 (470)	8.84 (224)	30.34 (771)	3" ANSI	3 (75)	1.62 (6.15)	260 (988)	3 (75)	125 (8.6)	125 (8.6)

Dimensional Tolerance: ±1/8" (± 3mm) • See service manual for complete specifications. G05 (Stainless Steel only), G1F, G15, G20 also available in ANSI Raised Face or Weld Neck flange. G30 available in DIN & ANSI Raised Face.



# VS COMPETITOR

SANDPIPER PUMPS EXCEL IN EVERY ASPECT OF SAFETY AND RELIABILITY WITHIN THE OIL & GAS INDUSTRY

### WIDEST AVAILABLE RANGE



### SIZE & FLOW

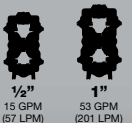

### WIDEST TEMPERATURE RANGE



### TEMP



### BROADEST CERTIFICATIONS IN THE INDUSTRY

SAFETY COMPLIANCE WITH:



### SAFETY

SAFETY COMPLIANCE WITH:



### LARGEST SOLIDS PASSAGE



### SOLIDS HANDLING

TOP DISCHARGE ONLY Up to ¼"

### EASE OF REPAIR AND LESS DOWNTIME

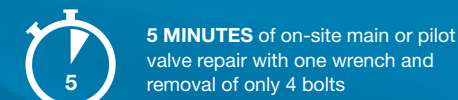

### GAS / AIR VALVE REPAIR

55 MINUTES of off-site main and pilot valve repair with a variety of tools needed to remove pump from line and transport for repair

### ENHANCED TEMPERATURE RESISTANCE AND CHEMICAL COMPATIBILITY



### GAS / AIR END MATERIALS

LIMITED Aluminum only Nitrile Elastomers only

### BEST GUARANTEE IN THE INDUSTRY

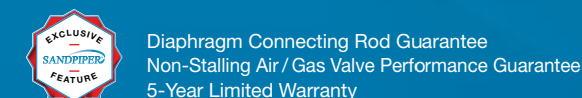

### PERFORMANCE RELIABILITY

LIMITED Connecting Rod prone to bending 5-year Limited Warranty

# UL LISTED PUMPS

PERFORMANCE & SPECIFICATIONS

UL (Underwriters Laboratories) Listed Pumps are designed to meet UL79 standards for diaphragm pumps handling flammable liquids. All Aluminum construction with approved Nitrile or Virgin PTFE UL elastomers. Fully groundable to prevent static discharge.



## 1" 25mm U1F Metallic Performance

- MAX FLOW** • 45 GPM (170 LPM)
- PORTING** • NPT / BSP
- AIR END** • Aluminum
- WET END** • Aluminum

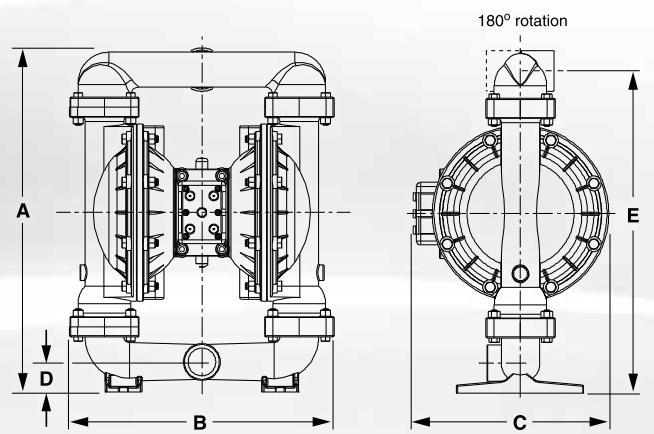
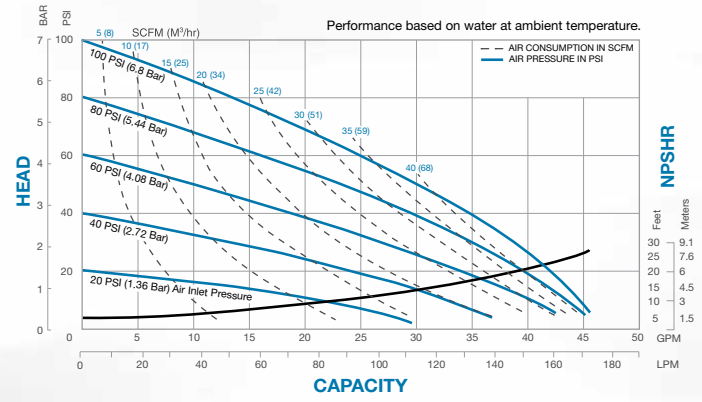

SCAN TO LEARN MORE  
SANDPIPERPUMP.COM/ULPUMPS



PUMP MODELS	A	B	C	D	E	Connection Style	Pipe Size	Displacement Per Stroke	Max Flow Per Minute	Max Solids Handling	Max Discharge Pressure
	Height	Width	Depth	Bottom of Base to Center Line of Suction	Center Line Discharge						
U1F	12.72 (323)	10.25 (260)	10.38 (264)	1.09 (28)	11.84 (301)	1" NPT	1 (25)	.11 (.42)	45 (170)	.25 (6)	125 (8.6)

Dimensional Tolerance: ±1/8" (± 3mm) • See service manual for complete specifications

# SUBMERSIBLE CENTRIFUGAL PUMPS

PERFORMANCE & SPECIFICATIONS

The PortaPump® Submersible, Battery-Powered Pump operates using any 12-volt car or truck battery. It comes equipped with cables and battery clips. Extremely portable, the pump weighs only 33 pounds (15 kg) and can fit through openings as small as 10" (25cm). Electrically safe and whisper quiet.

## 1 1/2" 38mm SPA1 1/2-E Metallic Performance

- MAX FLOW** • 43 GPM (163 LPM)
- PORTING** • NPT / BSP
- WET END** • Aluminum

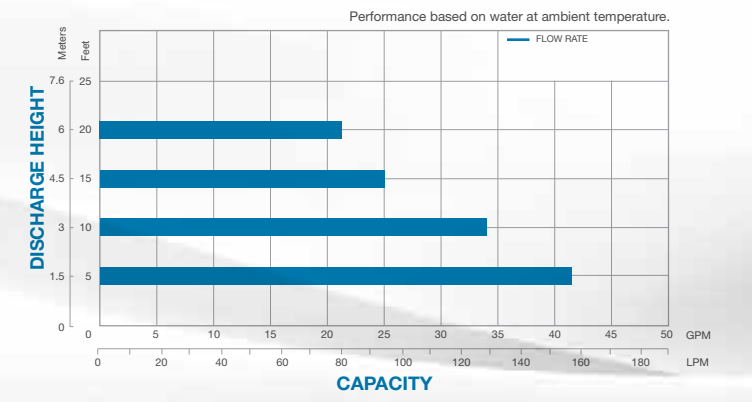

The SludgeMaster™ Submersible, Air-Powered Trash Pump handles mud, leaves, twigs, sand, sludge, trash-laden water and soft solids to 1 1/2" (3.8cm). High capacity, low head. The pump weighs only 59 pounds (26kg), and can fit through an opening as small as 14" (35cm). Sturdy construction for rough handling and long life. Optional rock screen available.

## 3" 75mm SMA3 Metallic Performance

- MAX FLOW** • 300 GPM (1140 LPM)
- PORTING** • NPT / BSP
- AIR END** • Aluminum
- WET END** • Aluminum

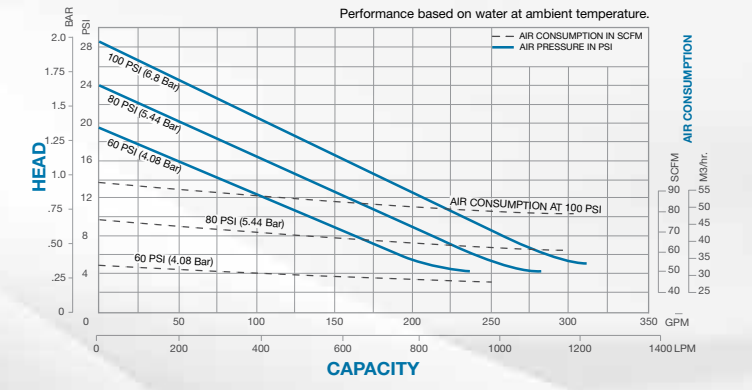

SCAN TO LEARN MORE  
SANDPIPERPUMP.COM/SUBMERSIBLE



PUMP MODELS	A	B	C	D	E	Connection Style	Pipe Size	Max Flow Per Minute	Max Solids Handling	Max Discharge Height
	Height	Width	Depth	Base to Center Discharge	Weight					
SPA1 1/2-E	22 (560)	8.88 (225)	6.19 (157)	4.71 (119)	33 (15)	1 1/2" NPT	1.5 (38)	43 (163)	.06 (1)	25 (7.6)
SMA3	23.51 (597)	13 (330)	9 (229)	7.11 (180)	59 (26)	3" NPT	3 (75)	300 (1140)	1.5 (40)	65 (19.8)

Dimensional Tolerance: ±1/8" (± 3mm) • See service manual for complete specifications

# PREMIUM FDA COMPLIANT PUMPS

## PERFORMANCE & SPECIFICATIONS

Our Premium FDA (Food & Drug Administration) Material Compliant Pumps are ideally suited for the ultimate in leak protection and clean pumping with the paired performance of AODD technology. Whether in a clean-in-place or clean-out-of-place application, these pumps will exceed the need for reliability and cleanability. Some of their most exceptional features include:

- Leak Detection**  
Pair with Electronic Leak Detection [LEARN MORE ON PAGE 63](#)
- Materials Of Construction**  
Electropolished 316 and 302/304 Stainless Steel Components
- Porting Options**  
Rotatable manifolds

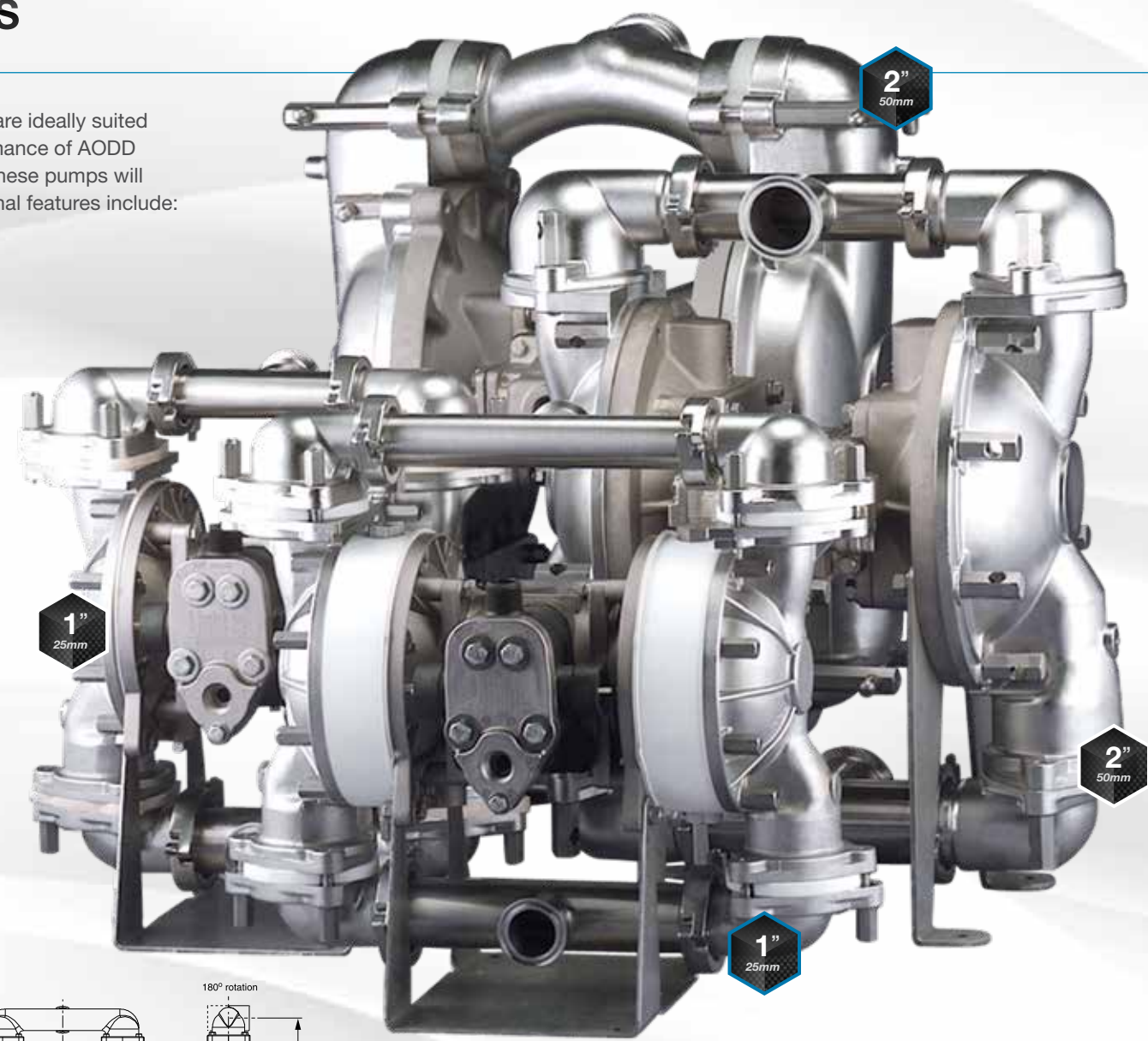

### 1" 25mm SSB1 / DSB1 Metallic Performance

- MAX FLOW** • 54 GPM (204 LPM)
- PORTING** • Tri-Clamp
- AIR END** • Nickel Plated Aluminum
- WET END** • Stainless Steel

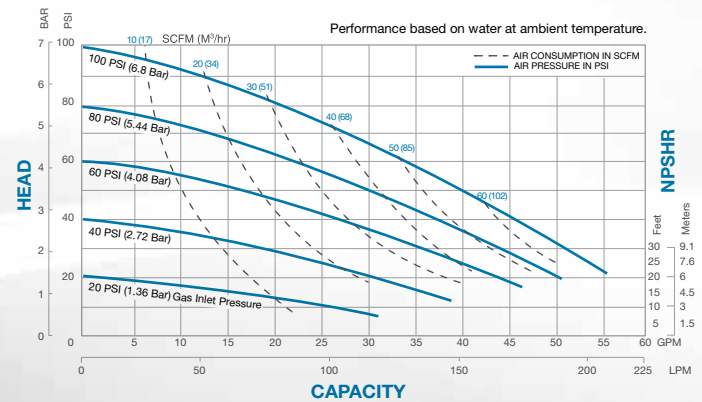

### 2" 50mm SSB2 Metallic Performance

- MAX FLOW** • 125 GPM (473 LPM)
- PORTING** • Tri-Clamp
- AIR END** • Nickel Plated Aluminum
- WET END** • Stainless Steel

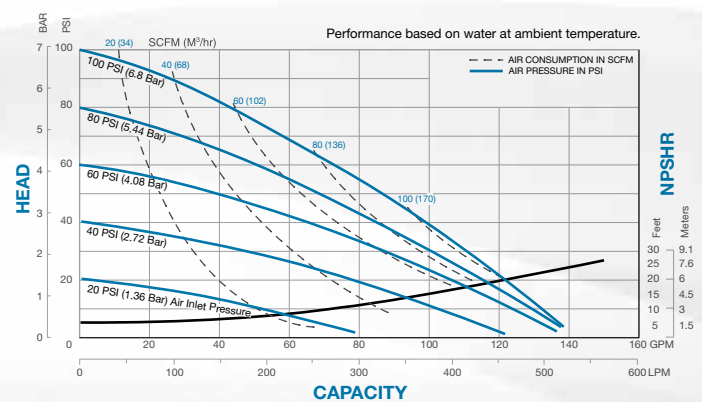

### 2" 50mm SSA2 Metallic Performance

- MAX FLOW** • 150 GPM (567 LPM)
- PORTING** • Tri-Clamp
- AIR END** • Nickel Plated Aluminum
- WET END** • Stainless Steel

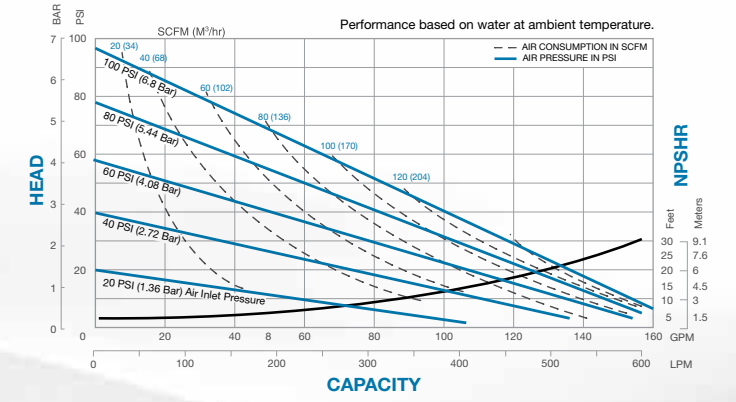

### 1" 25mm SET1 Metallic Performance

- MAX FLOW** • 54 GPM (204 LPM)
- PORTING** • Tri-Clamp
- AIR END** • Nickel Plated Aluminum
- WET END** • Stainless Steel

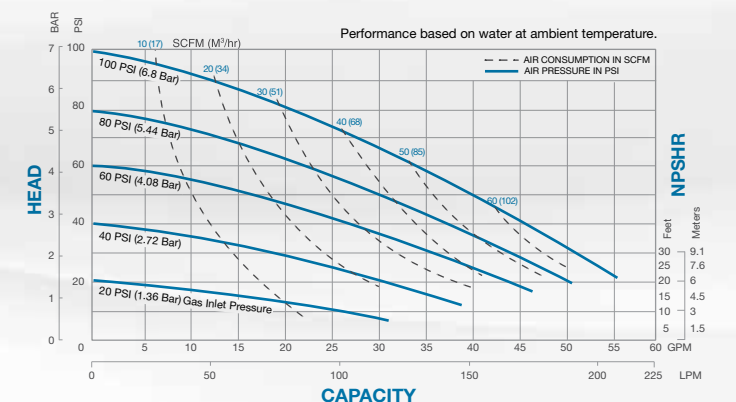

### 2" 50mm SET2 Metallic Performance

- MAX FLOW** • 123 GPM (465 LPM)
- PORTING** • Tri-Clamp
- AIR END** • Nickel Plated Aluminum
- WET END** • Stainless Steel

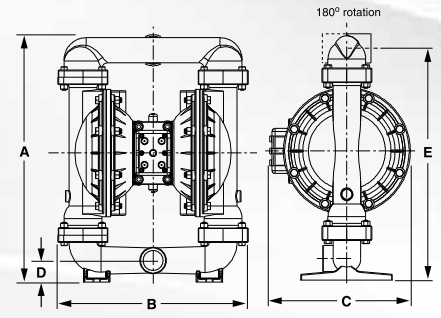
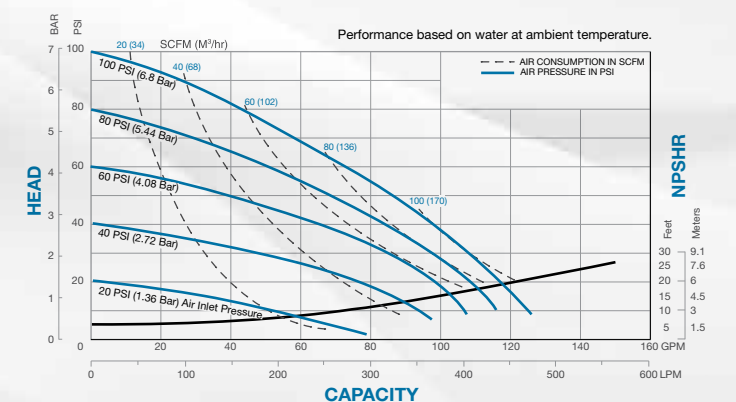

**EC-1935**  
Food Processing plastic and elastomer food contact components meet the requirements of EU Regulation 1935/2004/EC. Refer to declaration of conformity for compliant models.

PUMP MODELS	SPECIFICATIONS					Connection Style	Pipe Size inch (mm)	Displacement Per Stroke gal (liter)	Max Flow Per Minute gal (liter)	Max Solids Handling inch (mm)	Max Discharge Pressure psi (bar)
	A	B	C	D	E						
	Height inches (mm)	Width inches (mm)	Depth inches (mm)	Bottom of Base to Center Line of Suction inches (mm)	Bottom of Base to Center Line of Discharge inches (mm)						
SSB1/DSB1	17.44 (443)	15.69 (398)	10.69 (271)	2.38 (60)	15.94 (404)	1½" Tri-Clamp	1 (25)	.09 (.34)	54 (204)	.25 (6)	125 (8.6)
SSB2	22.63 (575)	18.88 (479)	12.81 (325)	2.75 (70)	21 (533)	2" Tri-Clamp	2 (50)	.36 (1.36)	125 (473)	.25 (6)	125 (8.6)
SSA2	25.63 (651)	20.06 (510)	16.25 (413)	3.94 (100)	24.13 (612)	2½" Tri-Clamp	2 (50)	.63 (2.39)	150 (570)	1.06 (27)	125 (8.6)
SET1	17.88 (454)	19 (483)	10.19 (268)	2.38 (60)	15.75 (400)	1" Tri-Clamp	1 (25)	.09 (.34)	54 (204)	.25 (6)	125 (8.6)
SET2	23.5 (597)	24.13 (613)	13 (330)	2.38 (60)	21.25 (540)	2" Tri-Clamp	2 (50)	.36 (1.36)	123 (465)	.25 (6)	125 (8.6)

Dimensional Tolerance: ±1/8" (± 3mm) • See service manual for complete specifications.

# STANDARD FDA COMPLIANT PUMPS

PERFORMANCE & SPECIFICATIONS

FDA (Food & Drug Administration) Material Compliant Pumps are ideally suited for a variety of food processing, pharmaceutical and cosmetic industry applications. The pumps are available in 1" through 3" ball check valve designs and a 2" (line size solids handling) flap check valve design. Variable flow capacities across the range are 0–235 gallons per minute. These special duty pumps are constructed of FDA compliant material components of Stainless Steel (wetted castings) and a selection of FDA Santoprene®, FDA Nitrile and PTFE diaphragms, check valves and valve seats. Standard non-wetted components are white Epoxy Coated Aluminum with Stainless Steel hardware. 1", 1½", 2", 3" pumps are offered with sanitary clamp fittings and 3" pumps are offered with an ANSI flange.

**Materials Of Construction**  
316 Stainless Steel components

**Porting Options**  
Rotatable manifolds and top or bottom discharge available

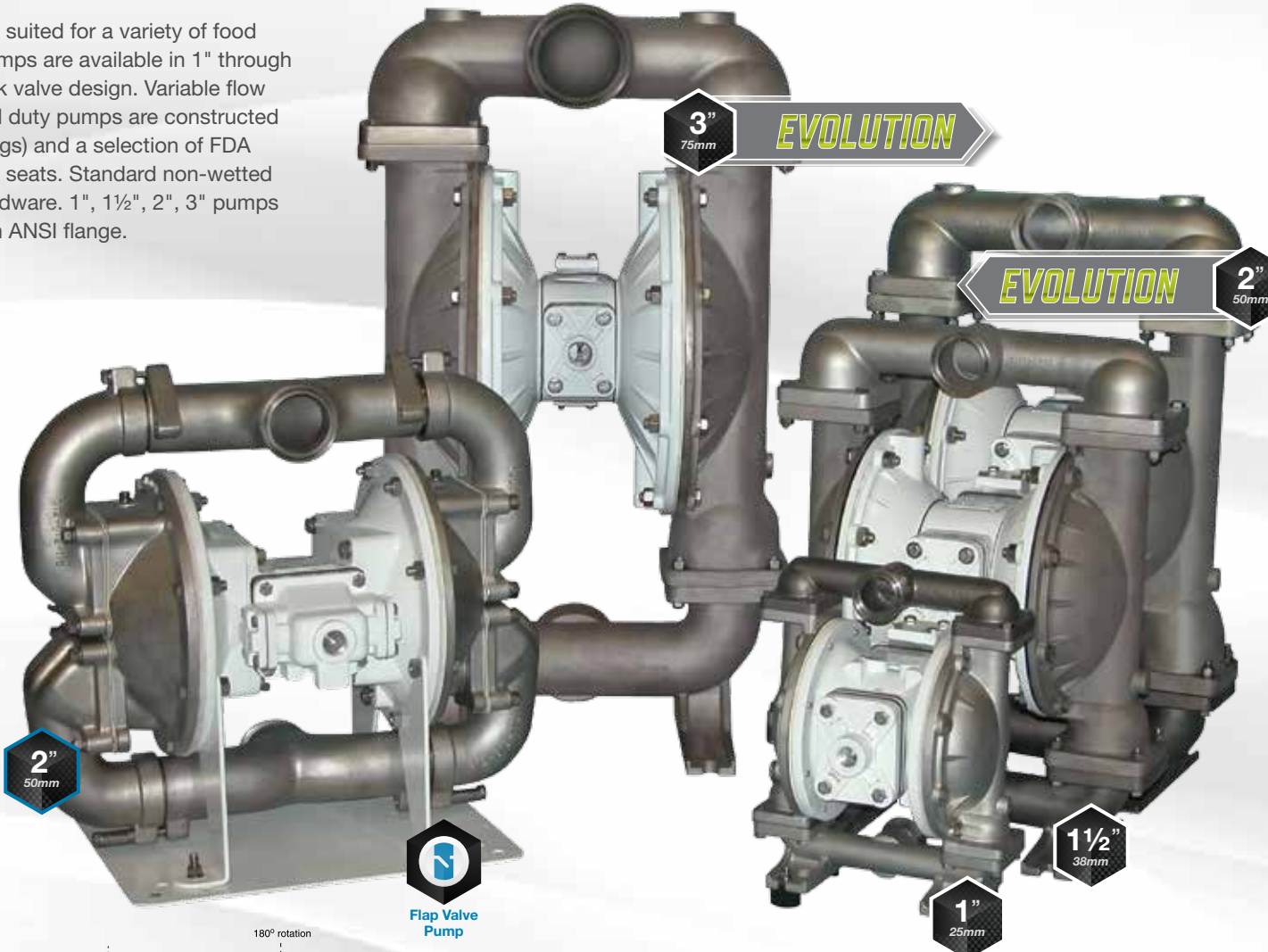

**1" 25mm T1F Metallic Performance**

**MAX FLOW** • 45 GPM (170 LPM)  
**PORTING** • Tri-Clamp  
**AIR END** • Epoxy Coated Aluminum  
**WET END** • Stainless Steel

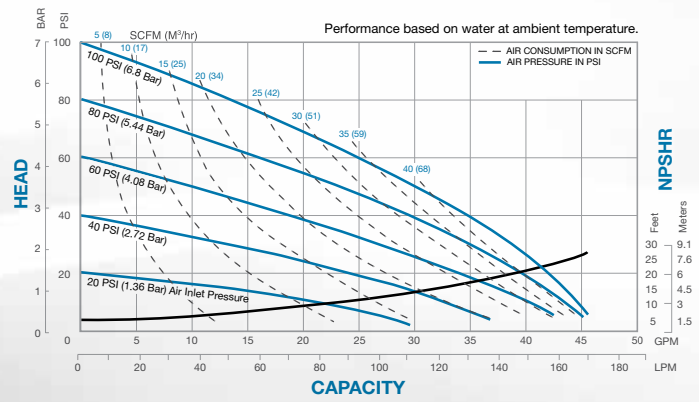

**1½" 38mm T15 Metallic Performance**

**MAX FLOW** • 106 GPM (401 LPM)  
**PORTING** • Tri-Clamp  
**AIR END** • Epoxy Coated Aluminum  
**WET END** • Stainless Steel

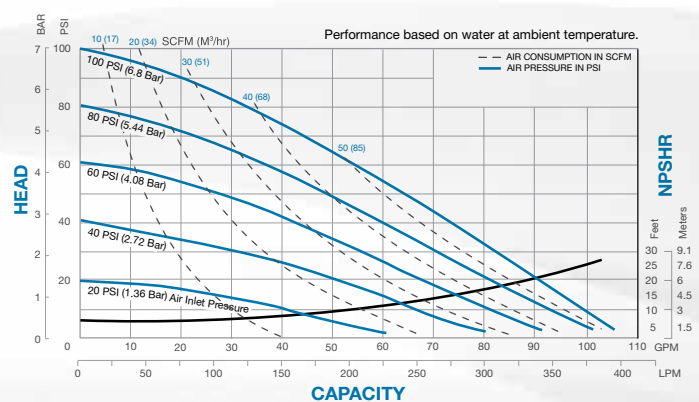

**2" 50mm T20 Metallic Performance**

**MAX FLOW** • 198 GPM (750 LPM)  
**PORTING** • Tri-Clamp  
**AIR END** • Epoxy Coated Aluminum  
**WET END** • Stainless Steel

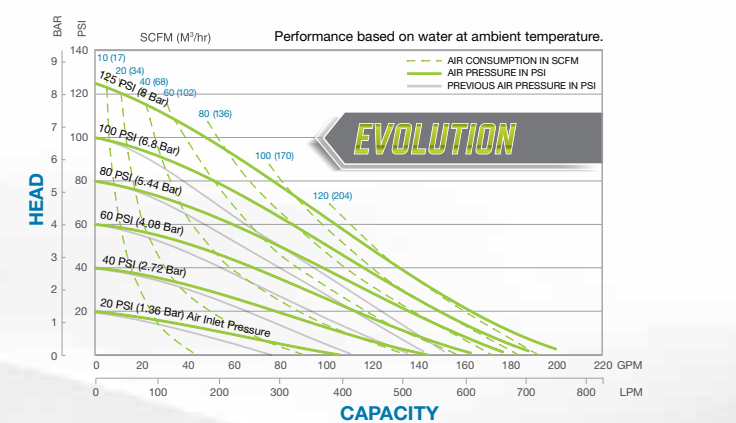

**3" 75mm T30 Metallic Performance**

**MAX FLOW** • 285 GPM (1,078 LPM)  
**PORTING** • ANSI Flange  
**AIR END** • Epoxy Coated Aluminum  
**WET END** • Stainless Steel

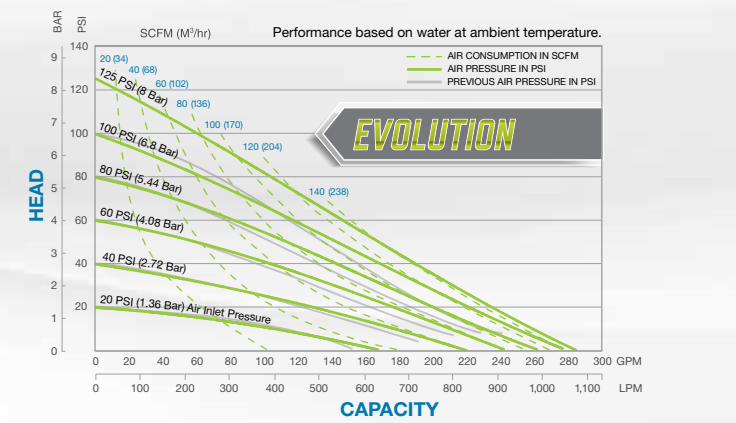

**1½" 38mm T15 Metallic Performance**

**MAX FLOW** • 106 GPM (401 LPM)  
**PORTING** • Tri-Clamp  
**AIR END** • Epoxy Coated Aluminum  
**WET END** • Stainless Steel

**2" 50mm TSA2 Metallic Performance**

**MAX FLOW** • 140 GPM (530 LPM)  
**PORTING** • Tri-Clamp  
**AIR END** • Epoxy Coated Aluminum  
**WET END** • Stainless Steel

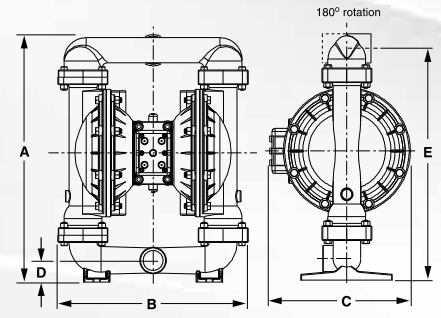
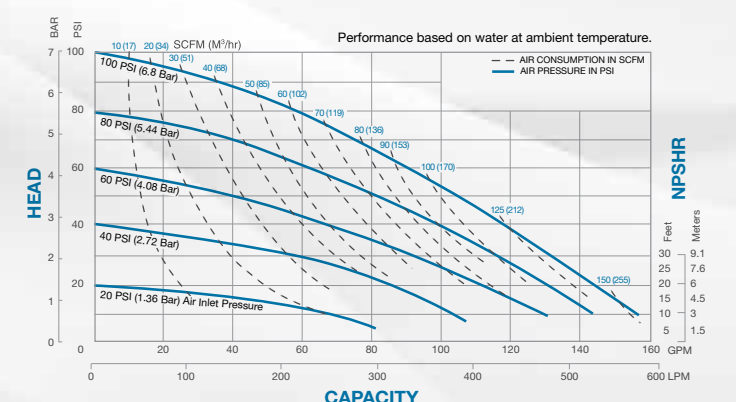

PUMP MODELS	A	B	C	D	E	Connection Style	Pipe Size	Displacement Per Stroke	Max Flow Per Minute	Max Solids Handling	Max Discharge Pressure
	Height	Width	Depth	Bottom of Base to Center Line of Suction	Center Line to Discharge						
T1F	12.97 (326)	10.25 (260)	10.38 (264)	1.22 (31)	11.97 (304)	1½" Tri-Clamp	1 (25)	.11 (.42)	45 (170)	.25 (6)	125 (8.6)
T15	21.81 (554)	16.66 (423)	12.36 (314)	1.97 (50)	20.38 (518)	2" Tri-Clamp	1.5 (38)	.41 (1.55)	106 (401)	.25 (6)	125 (8.6)
T20	26.56 (674)	16.88 (428)	12.59 (320)	2 (50)	24.75 (629)	2½" Tri-Clamp	2 (50)	.42 (1.59)	198 (750)	.25 (6)	125 (8.6)
T30	32.28 (820)	19.66 (499)	15.75 (400)	4.22 (107)	30.84 (808)	4" Tri-Clamp	3 (75)	.94 (3.56)	285 (1,078)	.38 (9.5)	125 (8.6)
TSA2	20.81 (529)	21.25 (539)	13 (330)	2.56 (65)	17.56 (447)	2½" Tri-Clamp	2 (50)	.43 (1.60)	140 (530)	2 (50)	125 (8.6)

Dimensional Tolerance: ±1/8" (± 3mm) • See service manual for complete specifications.

**EC-1935**  
Food Processing plastic and elastomer food contact components meet the requirements of EU Regulation 1935/2004/EC. Refer to declaration of conformity for compliant models.

Santoprene is a registered trademark of Exxon Mobil Corporation.

# MINE & CONSTRUCTION PUMPS

PERFORMANCE & SPECIFICATIONS

When durability and reliability are paramount in the rigorous environments of today's mines and construction sites, our mining and construction pumps are a great solution. With more ways than one, these pumps are designed to be tossed, dragged and crammed into position to get the fluids you need removed in a hurry. Some of the most attractive features of these pumps are:

- Ease of Use**  
Superior on-off-on reliability and easy to move with built in handles
- Base Mounting Options**  
Skid mount, roll cage, and strainer bases available
- Performance**  
High flow and solids size options available

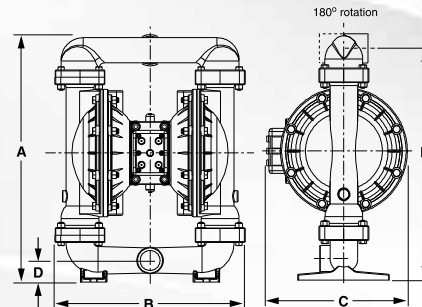
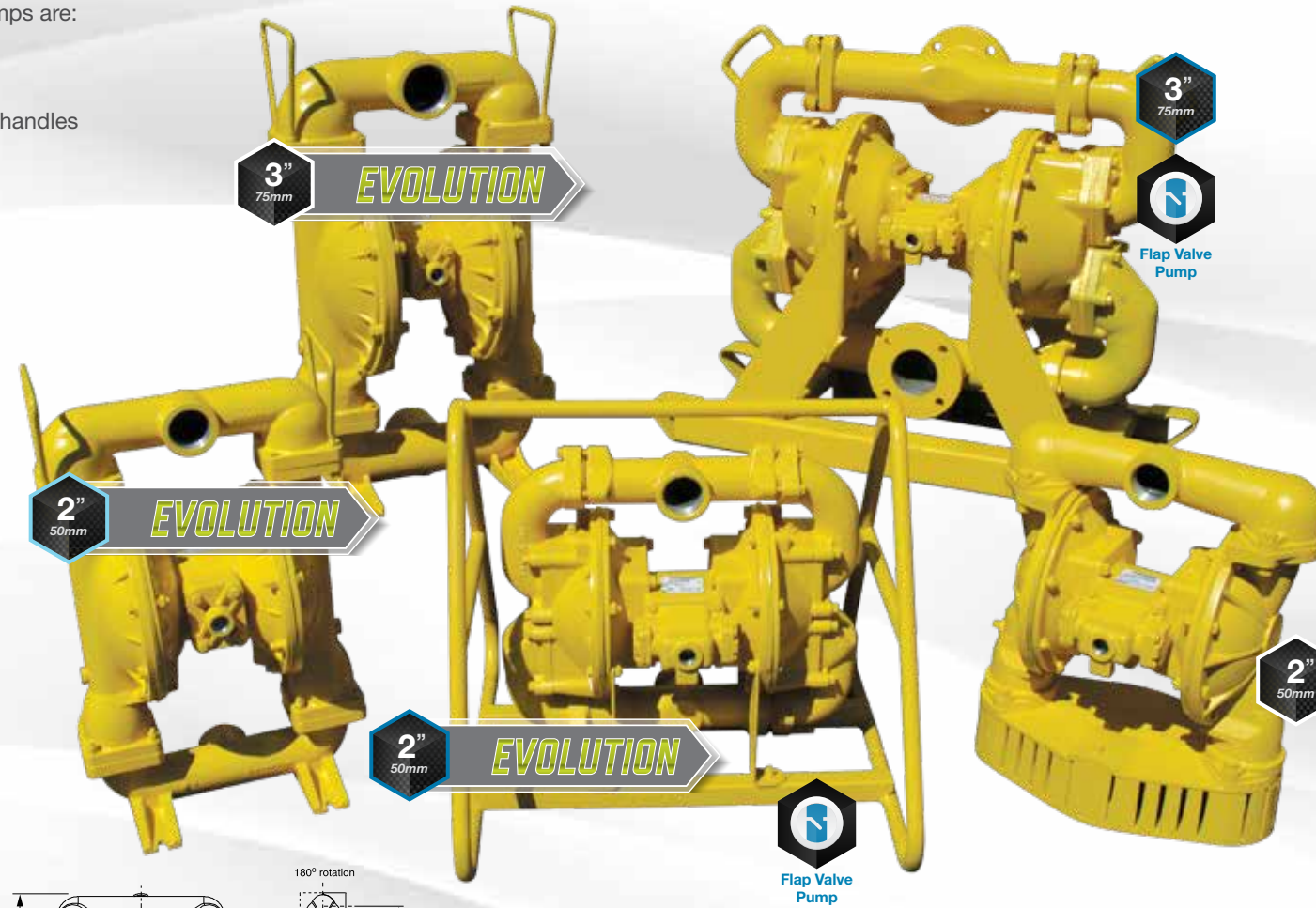

SPECIFICATIONS											
PUMP MODELS	A	B	C	D	E	Connection Style	Pipe Size	Displacement Per Stroke	Max Flow Per Minute	Max Solids Handling	Max Discharge Pressure
	Height	Width	Depth	Bottom of Base to Center Line of Suction	Center Line to Center Line of Discharge						
	inches (mm)	inches (mm)	inches (mm)	inches (mm)	inches (mm)		inch (mm)	gal (liter)	gal (liter)	inch (mm)	psi (bar)
MSB2	Variable	Variable	Variable	Variable	Variable	2" NPT / BSP	2 (50)	.36 (1.36)	125 (473)	.25 (6)	125 (8.6)
MSA3-C	Variable	Variable	Variable	Variable	Variable	3" #125 ANSI	3 (75)	1.62 (6.15)	260 (988)	3 (75)	125 (8.6)
MSA2	Variable	Variable	Variable	Variable	Variable	2" NPT / BSP	2 (50)	.47 (1.78)	208 (787)	2 (50)	125 (8.6)
S20	26.31 (669)	16.88 (428)	12.59 (320)	1.88 (48)	24.63 (625)	2" NPT / BSP	2 (50)	.42 (1.59)	198 (750)	.25 (6)	125 (8.6)
S30	32.06 (814)	19.66 (499)	15.75 (400)	2.34 (60)	29.97 (761)	3" NPT / BSP	3 (75)	.94 (3.56)	285 (1,078)	.38 (9.5)	125 (8.6)

Dimensional Tolerance: ±1/8" (± 3mm) • See service manual for complete specifications.

## 2" 50mm MSA2 / MSA2-B / MSA2-C Metallic Performance

- MAX FLOW**  
• 208 GPM (787 LPM)
- PORTING**  
• NPT / BSP
- AIR END**  
• Aluminum
- WET END**  
• Aluminum

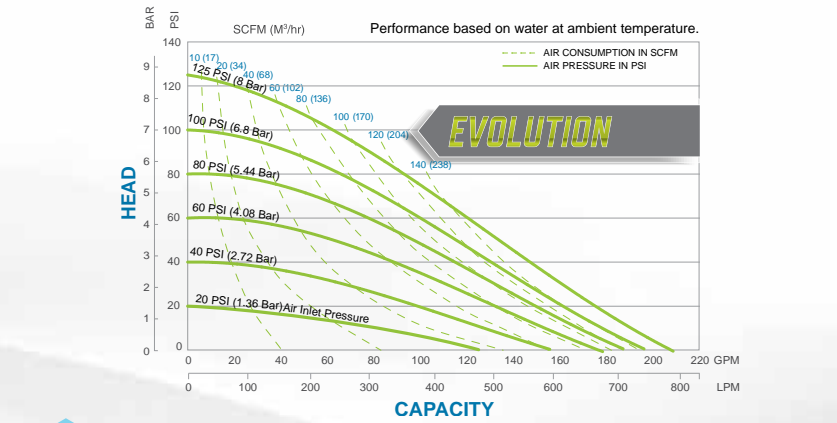

## 2" 50mm S20 Metallic Performance

- MAX FLOW**  
• 198 GPM (750 LPM)
- PORTING**  
• NPT / BSP  
• ANSI / DIN Flange
- AIR END**  
• Aluminum
- WET END**  
• Aluminum  
• Stainless Steel  
• Cast Iron

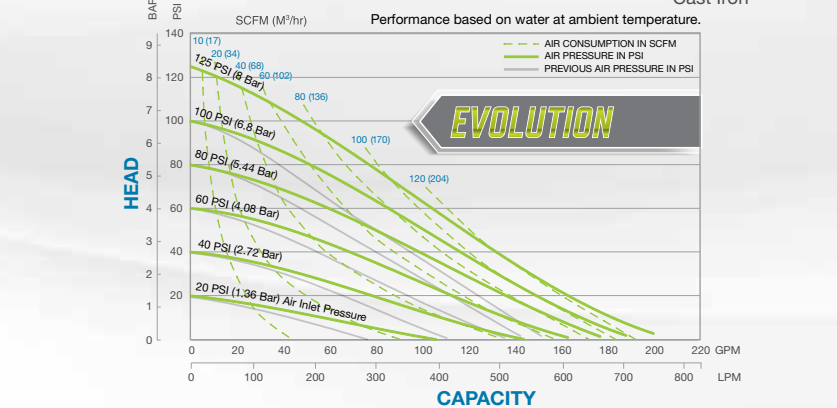

## 3" 75mm S30 Metallic Performance

- MAX FLOW**  
• 285 GPM (1,078 LPM)
- PORTING**  
• NPT / BSP  
• ANSI / DIN Flange
- AIR END**  
• Aluminum
- WET END**  
• Aluminum  
• Stainless Steel  
• Cast Iron

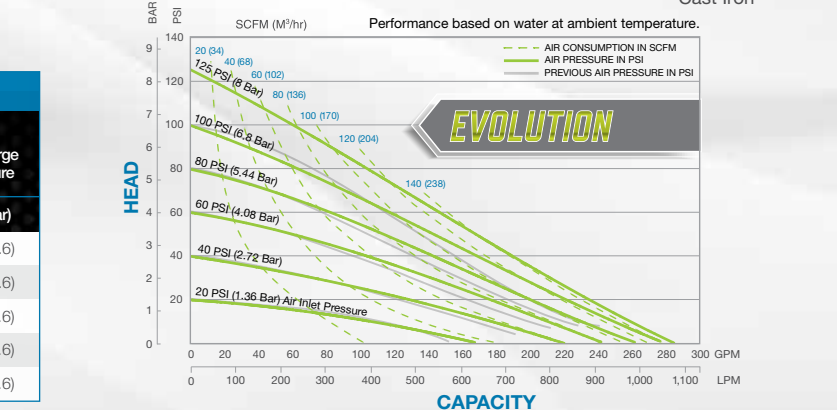

## 2" 50mm MSB2 Metallic Performance

- MAX FLOW**  
• 125 GPM (473 LPM)
- PORTING**  
• NPT / BSP
- AIR END**  
• Aluminum
- WET END**  
• Aluminum

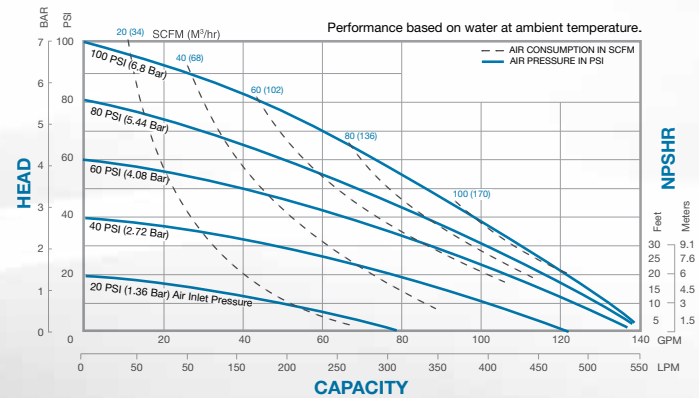

## 3" 75mm MSA3/MSA3-C Metallic Performance

- MAX FLOW**  
• 260 GPM (988 LPM)
- PORTING**  
• ANSI Flange
- AIR END**  
• Aluminum
- WET END**  
• Aluminum

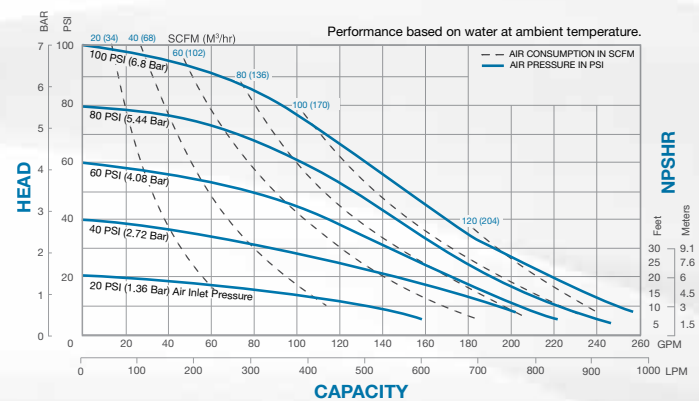





# HIGH PRESSURE PUMPS

## PERFORMANCE & SPECIFICATIONS

Air-Powered Single Diaphragm High Pressure Metallic Pumps deliver discharge pressure twice the inlet pressure, up to 250 PSI (17.2 BAR). Designed for filter press feed and applications requiring higher discharge pressures. Available in Aluminum, Cast Iron and Stainless Steel with various elastomer options. Equipped with elastomeric seals and components that are compatible with the various chemicals normally expected to be found in natural gas.

The Blagdon N25 and N50 High Pressure Pumps provide enhanced power in applications where pressure is paramount and flow rate is an issue. Using two air chambers to double the air per stroke, these pumps achieve discharge pressure up to 238 PSI (16 Bar) with flow rates as high as 30 GPM (114 LPM) for N25 and as high as 90 GPM (341 LPM) with N50.

-  **Maximum Flow Control**  
High pressure capabilities allow for optimum control
-  **Heavy Duty**  
Bolted construction and made with robust materials
-  **Unique Orientation**  
Single end discharge and suction available
-  **Reliability**  
Tested to ensure the long lasting performance
-  **Non-Freezing, Non-Stalling**  
Patented air valve will never unexpectedly stop

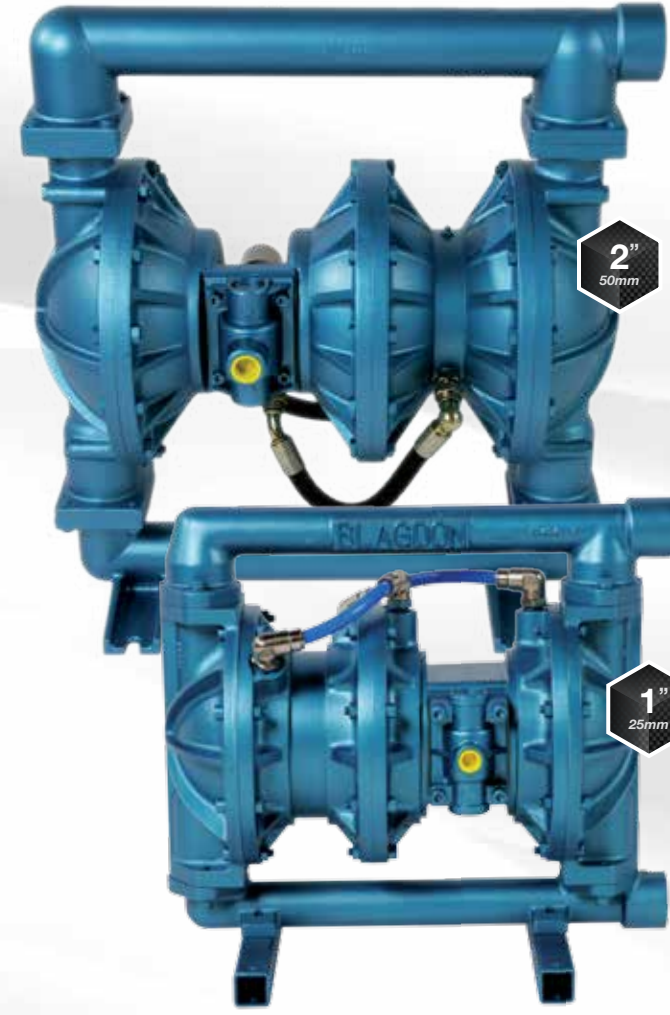

**ONLY High Pressure Flap Valve Pump in the WORLD**

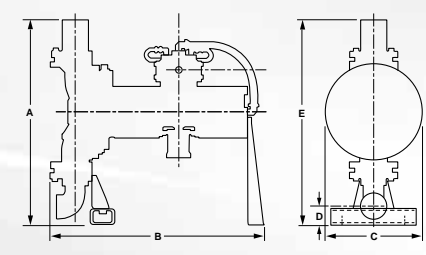

### SPECIFICATIONS

PUMP MODELS	A	B	C	D	E	Connection Style	Pipe Size	Displacement Per Stroke	Max Flow Per Minute	Max Solids Handling	Max Fluid Discharge Pressure	Max Air/Gas Inlet Pressure
	Height	Width	Depth	Bottom of Base to Center Line of: Suction	Discharge							
EH2-M/GH2-M	25 (635)	25.81 (656)	11.75 (298)	2.18 (56)	25 (635)	2" NPT	2 (50)	.36 (1.4)	74 (280)	.25 (6)	250 (17)	125 (8.6)
SH2-M	18.56 (471)	26.87 (683)	11.37 (289)	11.47 (291)	5.34 (136)	2" NPT	2 (50)	.30 (1.1)	62 (235)	2 (50)	250 (17)	125 (8.6)
N25	15.94 (405)	18.27 (464)	11.02 (280)	1.97 (50)	14.95 (380)	1" BSP	1 (25)	.13 (.5)	30 (125)	.13 (3)	232 (16)	117 (8)
N50	24.41 (620)	28.70 (729)	13.07 (332)	3.66 (93)	22.95 (583)	2" BSP	2 (50)	.42 (1.9)	75 (341)	.25 (6)	232 (16)	117 (8)

Dimensional Tolerance: ±1/8" (± 3mm) • See service manual for complete specifications.

## 2" 50mm EH2-M / GH2-M Metallic Performance

- MAX FLOW**  
• 74 GPM (280 LPM)
- PORTING**  
• NPT
- AIR END**  
• E: Aluminum  
• G: Cast Iron
- WET END**  
• Cast Iron  
• Stainless Steel

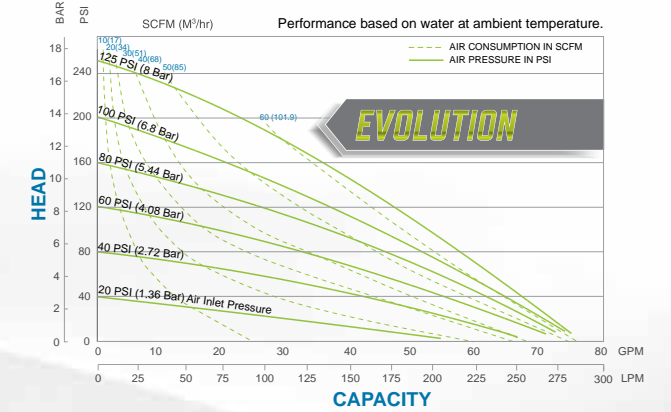

## 1" 25mm N25 Metallic Performance

- MAX FLOW**  
• 30 GPM (114 LPM)
- PORTING**  
• NPT / BSP
- AIR END**  
• Aluminum
- WET END**  
• Aluminum  
• Stainless Steel

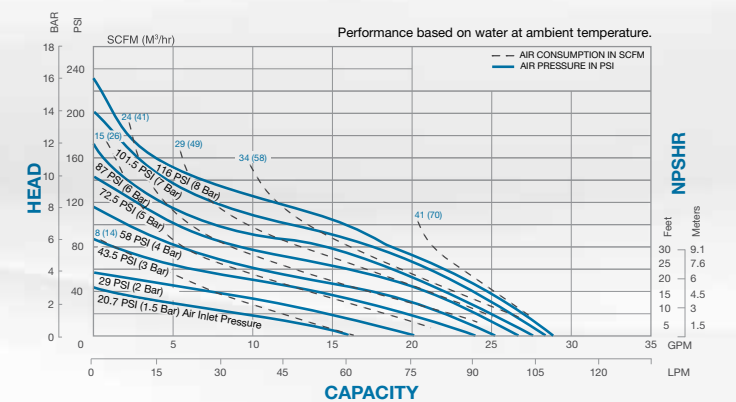

## 2" 50mm N50 Metallic Performance

- MAX FLOW**  
• 90 GPM (341 LPM)
- PORTING**  
• NPT / BSP
- AIR END**  
• Aluminum
- WET END**  
• Aluminum  
• Stainless Steel

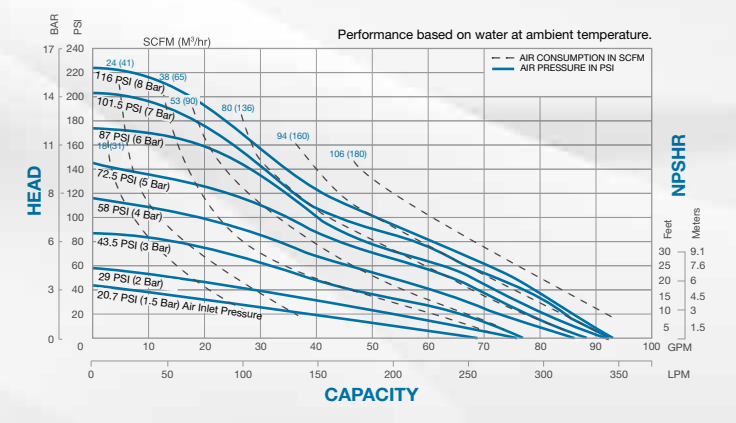

## 2" 50mm SH2-M Metallic Performance

- MAX FLOW**  
• 62 GPM (235 LPM)
- PORTING**  
• NPT
- AIR END**  
• Aluminum
- WET END**  
• Aluminum  
• Cast Iron

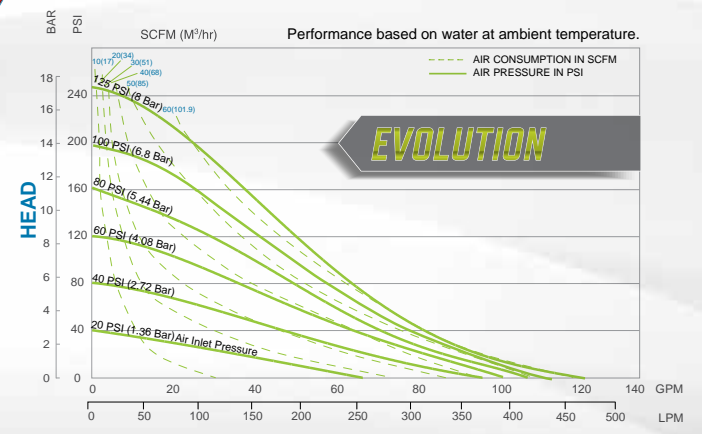

# FILTER PRESS SYSTEMS

DESCRIPTION & SPECIFICATIONS

## Built-to-Order, Multi-Pump Systems

Combine a high volume fill pump with a high pressure feed pump. Frequently used for filter press feed applications, the systems produce operating pressures to 250 PSI (17 BAR). This results in shortened press cycles, drier cake and less costly disposal.

## Base Systems



SCAN TO LEARN MORE  
SANDPIPERPUMP.COM/FILTERPRESS

### 040.010.000 consists of:

- (1) S20W1INCANS100
- (1) EH2-M, TN-4-I
- Filter/Regulator (1) 020.052.000
- Filter/Regulator (1) 020.051.000
- Includes base & piping with 2" flange suction & discharge connections

### 040.011.000. consists of:

- (1) S30W1INCANS100
- (1) EH2-M, TN-4-I
- Filter/Regulator (1) 020.052.000
- Filter/Regulator (1) 020.051.000
- Includes base & piping with 3" flange suction & discharge connections

### 040.003.000. consists of:

- (1) SA2-A, DA-5-II
- (1) SH2-M, DN-7-I
- Filter/Regulator (1) 020.052.000
- Filter/Regulator (1) 020.051.000
- Includes base & piping with 2" flange suction & discharge connections

### 040.004.000. consists of:

- (1) SA3-M, DA-2-II
- (1) SH2-M, DN-7-I
- Filter/Regulator (1) 020.052.000
- Filter/Regulator (1) 020.051.000
- Includes base & piping with 3" flange suction & discharge connections

## Consult Factory For:

- Lead time
- Pricing
- Combinations of pumps for other systems

Custom built heavy duty wastewater, filter press pumping system.

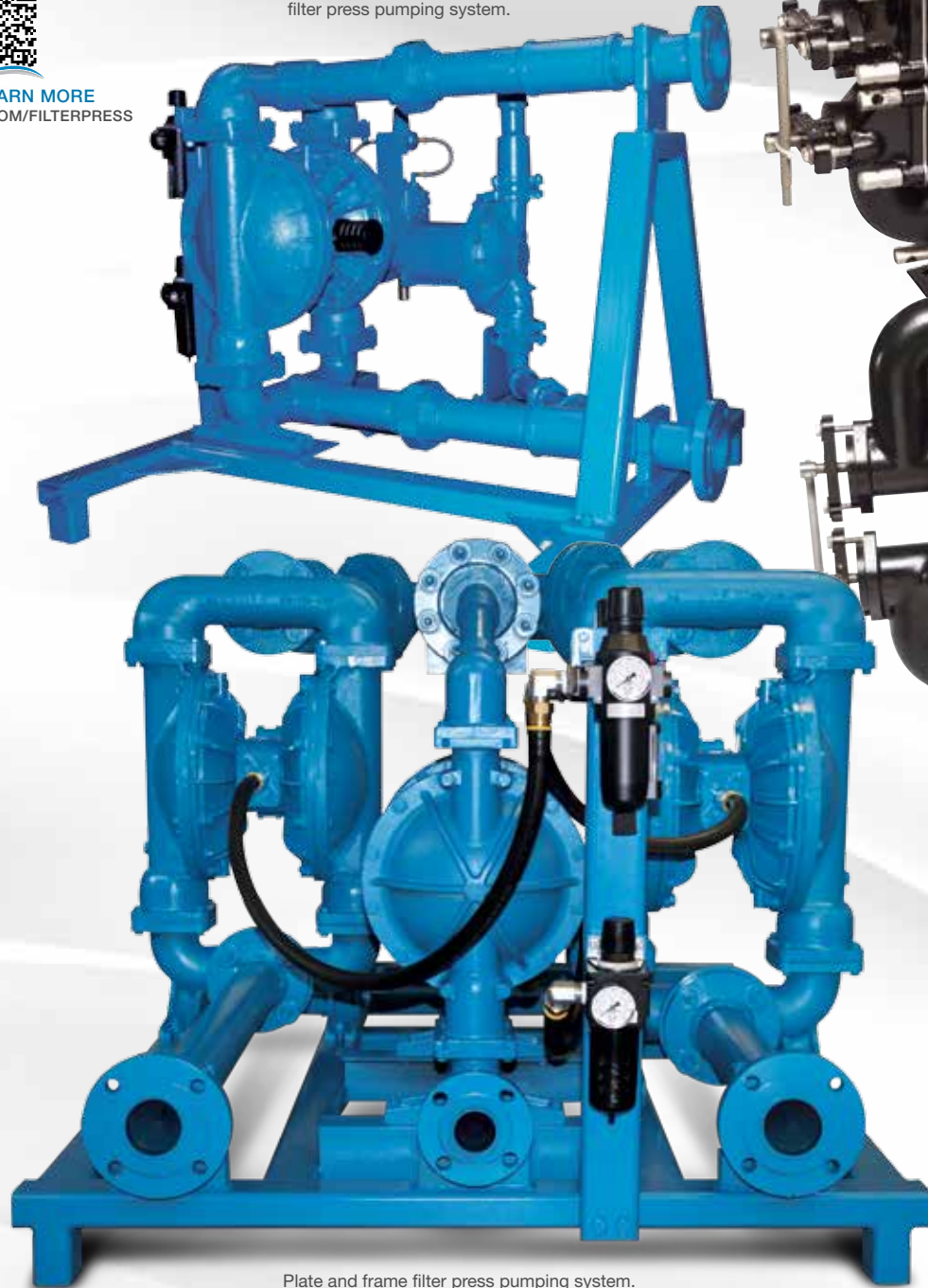
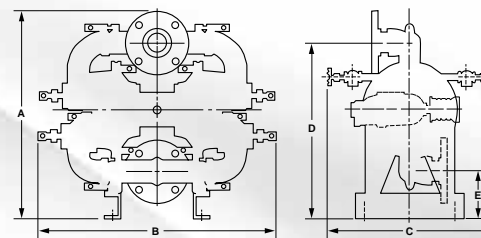
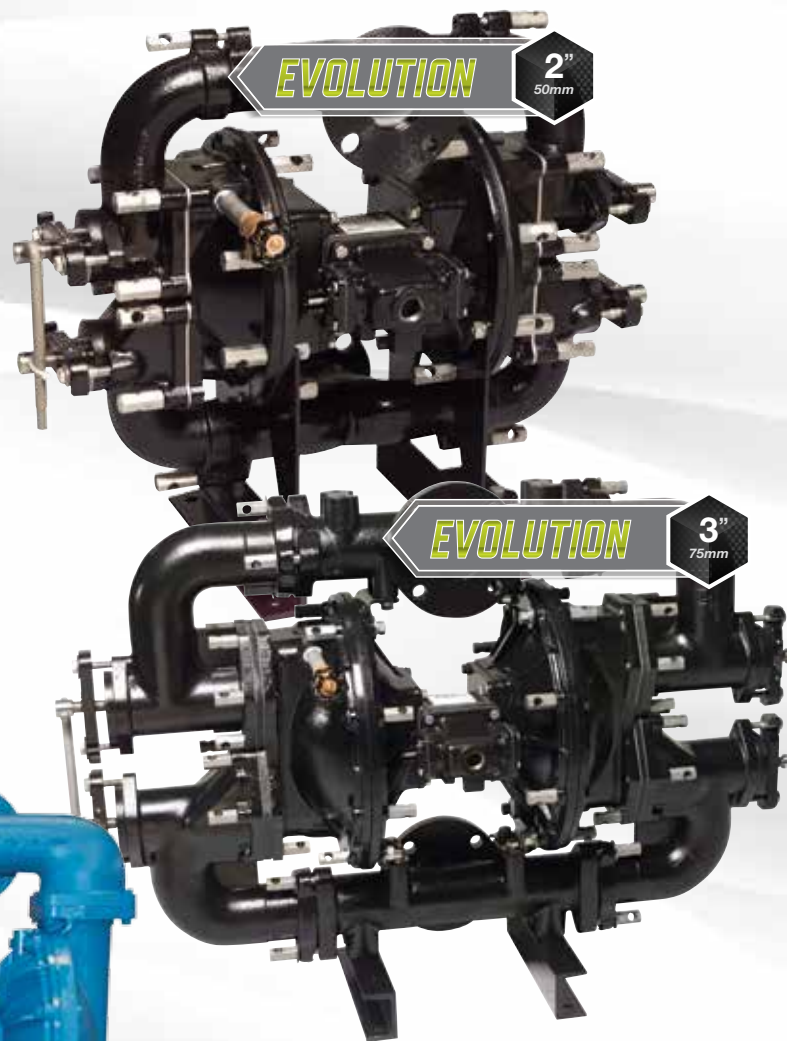

Plate and frame filter press pumping system.



SCAN TO LEARN MORE  
SANDPIPERPUMP.COM/WASTEWATER

# WASTEWATER PUMPS

PERFORMANCE & SPECIFICATIONS

Non-Clog Wastewater Pumps are fitted with swing check valves and easy access clean-outs. The pumps are designed specifically for slurry and solids-laden materials. Flap valves allow passage of suspended, pipe-size solids and stringy material. Constructed of cast iron and durable epoxy coating inside and out.

## 2" W09 Metallic Performance



- MAX FLOW** • 208 GPM (787 LPM)
- PORTING** • ANSI Flange
- AIR END** • Cast Iron
- WET END** • Cast Iron

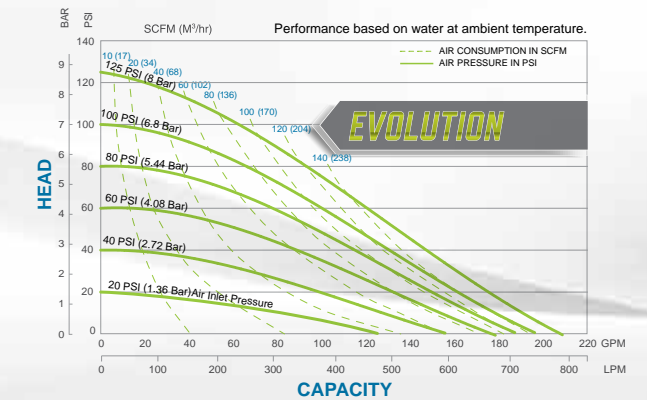

## 3" W15 Metallic Performance



- MAX FLOW** • 303 GPM (1147 LPM)
- PORTING** • ANSI Flange
- AIR END** • Cast Iron
- WET END** • Cast Iron

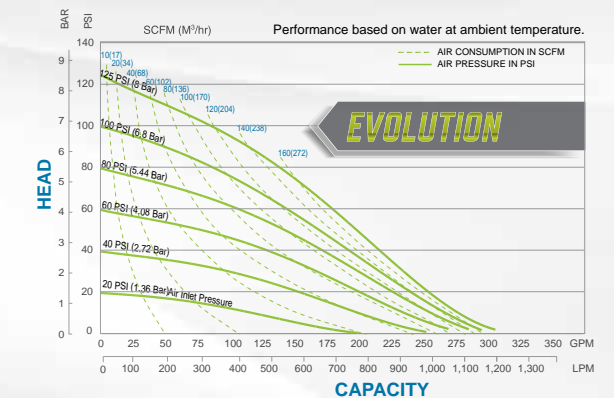

### SPECIFICATIONS

PUMP MODELS	A	B	C	D	E	Connection Style	Pipe Size	Displacement Per Stroke	Max Flow Per Minute	Max Solids Handling	Max Discharge Pressure
	Height	Width	Depth	Bottom of Base to Center Line of Suction	Center Line of Discharge						
	inches (mm)	inches (mm)	inches (mm)	inches (mm)	inches (mm)		inch (mm)	gal (liter)	gal (liter)	inch (mm)	psi (bar)
W09-2	23.75 (608)	28.25 (724)	19.75 (506)	20.75 (531)	5.63 (144)	2" 125# ANSI	2 (50)	.47 (1.78)	208 (787)	2 (50)	125 (8.6)
W09-3	24.5 (627)	28.25 (724)	19.75 (506)	20.75 (531)	5.63 (144)	3" 125# ANSI	3 (75)	.47 (1.78)	208 (787)	2 (50)	125 (8.6)
W15-3	31.5 (800)	44.5 (1130)	21.5 (546)	27.75 (705)	6 (152)	3" 125# ANSI	3 (75)	1.15 (4.35)	303 (1147)	3 (75)	125 (8.6)
W15-4	32.25 (819)	44.5 (1130)	21.5 (546)	27.75 (705)	6 (152)	4" 125# ANSI	4 (102)	1.15 (4.35)	303 (1147)	3 (75)	125 (8.6)

Dimensional Tolerance: ±1/8" (± 3mm) • See service manual for complete specifications.

# ACCESSORIES

ALL OF THE ITEMS YOU NEED TO COMPLETE YOUR SYSTEM

 **Enhanced Pump Performance and Productivity**

 **Extended MTBF (Mean Time Between Failure)**

 **Protection of Ancillary Equipment in Fluid Flow Path**

 **Enhanced Safety and Environmental Responsibility**

 **Precision Pump Control and Air Efficiency**

## Electronic Speed Control

Provides accurate control of variable flow rates, from zero flow to maximum. Operates on 110 or 220VAC with on-board, single turn potentiometer or automatic mode for remote control using the optional 4-20 mA input terminal.

## Air Filter / Regulator

Provides clean, dry air to your AODD pump. The SANDPIPER Filter / Regulator line offers modular convenience for easy installation and service.

[LEARN MORE ON PAGE 64](#)

## Stroke Counter/Batch Control

Offers performance and repeatability with an interfaceable electronic control to program repetitive diaphragm pump operations. The complete system requires the Batch Controller, the Pulse Output Kit & the Air Line Solenoid.

## Pulsation Dampener / Surge Suppressor

Provides virtually pulse-free discharge flow, for steadier pressure with less system vibration and noise. Our Tranquilizer® series is self-charging and self-venting.

[LEARN MORE ON PAGE 65](#)

## Liquid Level Control

Automatic, float actuated control unit that opens and closes the air supply to your AODD pump, especially useful in sump and liquid transfer situations.

[LEARN MORE ON PAGE 66](#)

## Water Separator

This point-of-use water separator is designed to remove 99% of the water, rust and other contaminants commonly present in compressed air lines. Clean, dry air enhances the life and performance of pneumatically-driven equipment.

## Inlet Stabilizer

Blacoh® Sentry® Inlet Stabilizers reduce pressure fluctuations and assist pump head filling during each inlet stroke. In high suction applications, stabilizer will momentarily maintain the flow of the accelerated fluid.

## Air Line Solenoid

Provides automatic on/off operation of air-driven equipment. 110/120VAC and 220/240VAC (50/60 hertz) kits operate with the SANDPIPER or customer's control units. 12VDC and 24VDC kits operate with customer-supplied controls only.

## Muffler

Rugged polymer or metallic housing that work as effective sound dampening for SANDPIPER pumps, meeting OSHA dBA requirements.

## Pulse Output Kit

Offered in a wide variety of sizes and voltages. These controls interface with the SANDPIPER Batch Controller, or your own process controls (PLCs). Available in kits for field installation, or factory built into a new pump.

## Leak Detection

Electronic versions provide a signal via warning lights, an audible alarm, and the pump can be shut down.

Visual versions simply have a sight tube that fills with fluid if a diaphragm breaks.

Mechanical leak detection opens an air valve, which activates a customer supplied solenoid to trigger a signal. For use with the Containment Duty Spill Containment SANDPIPER pumps only.

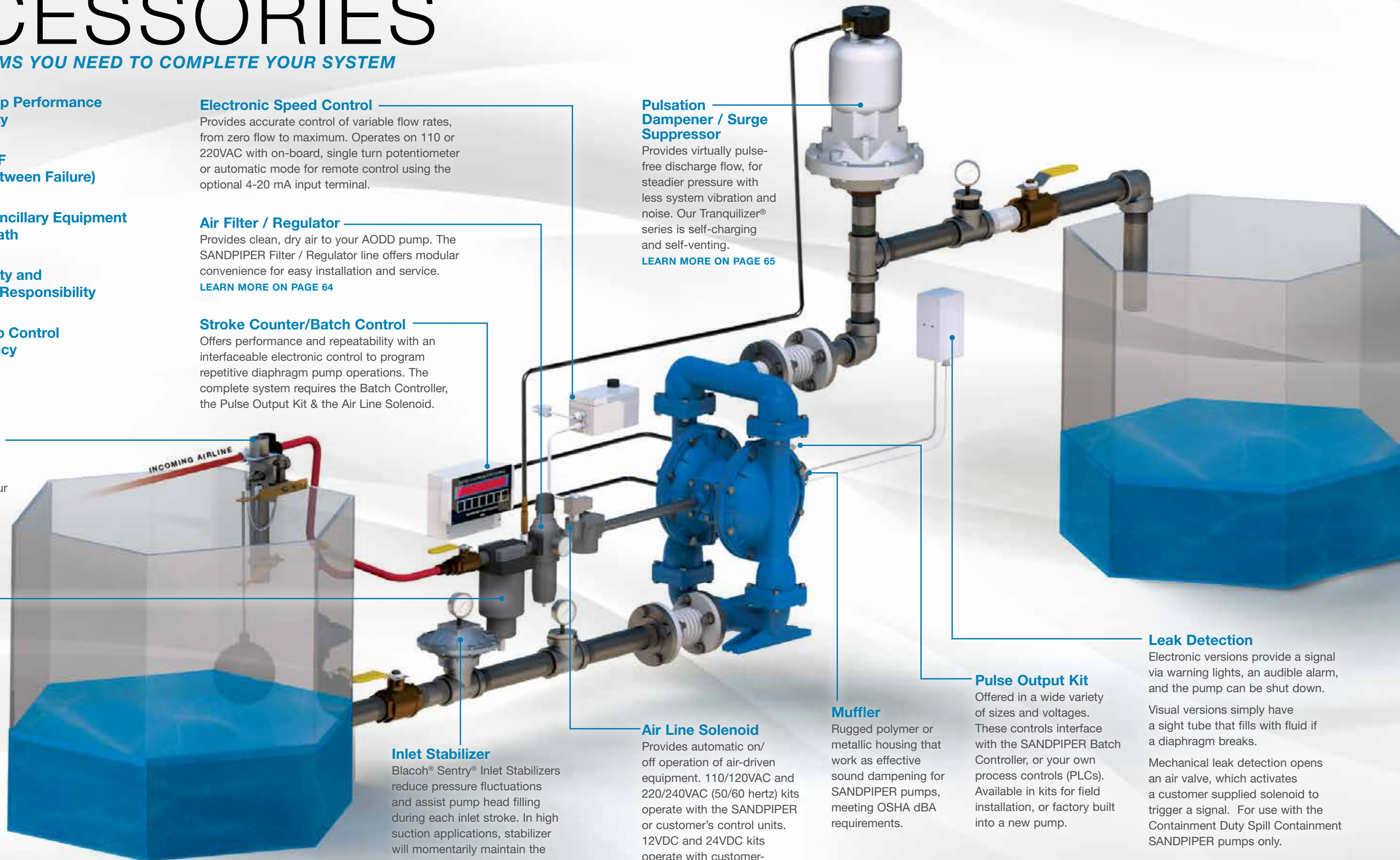



# FILTER REGULATORS

RELIABLE FILTER / REGULATORS SPECIFICALLY DEVELOPED FOR AIR OPERATED DOUBLE DIAPHRAGM PUMPS

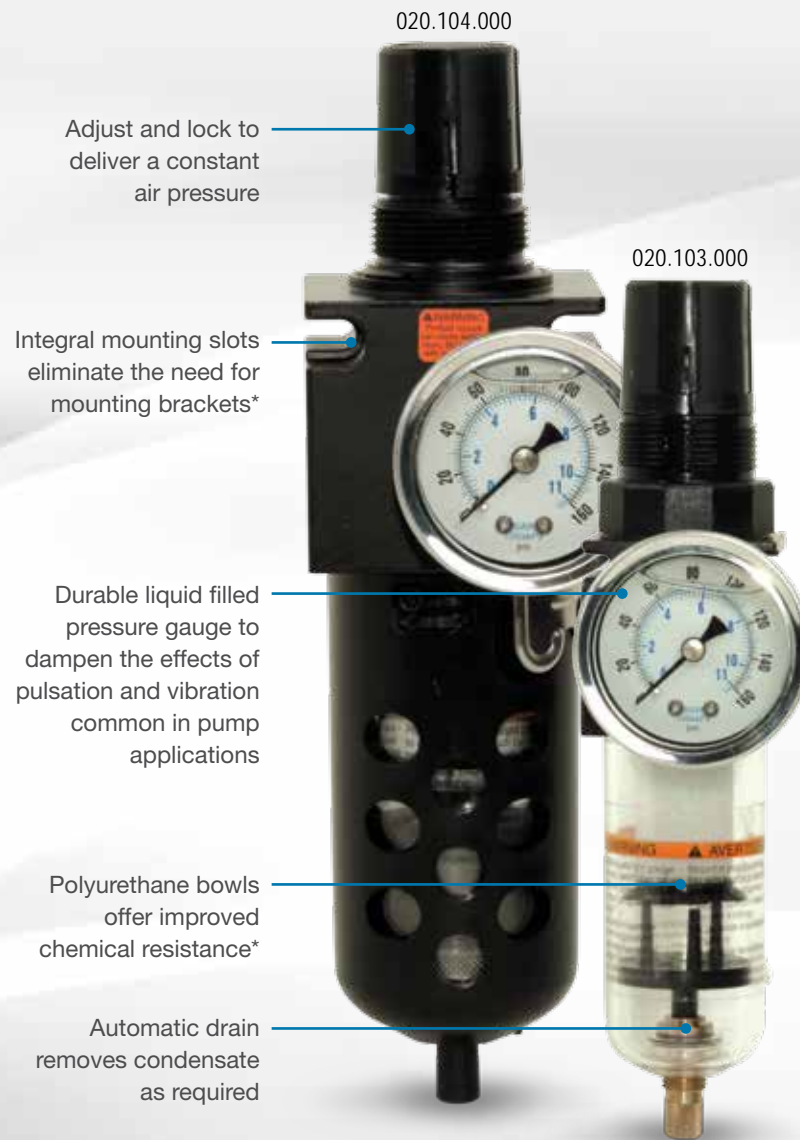

- Reduced Maintenance**  
Clean, regulated air
- Lower Operating Costs**  
Reduced air consumption and less compressor demand
- Extended Pump Life**  
Reduced stress on wear components by proportioning the air pressure
- Reliable**  
Engineered to optimize pump performance
- Protect**  
Efficiently removing air line solids and liquid contaminants to protect air valve
- Safe Operation**  
Operate at the lowest required air pressure
- Compact & Convenient**  
Filter and regulate your air supply in a single, easy to install unit
- Precise Pump Control**  
Easy air pressure adjustment to vary the pump's flow rate and operation speed

## Lubricators

In applications with very dry air supplies or where nitrogen is being utilized to operate the pump, lubrication of the compressed air supply is required. For these situations, we offer a complete line of Lubricators that easily connect to our Filter / Regulators.



\* Up to 3/4" units.

TECHNICAL SPECIFICATIONS										
Part Number	Port Size	Max Flow (SCFM)	Description	Max Inlet Pressure	Regulating Pressure Range	Replacement Filter Element Part Number	Lockout Valve Part Number	Mounting Bracket Kit Part Number	Replacement Pressure Gauge Part Number	Lubricator Part Number
020.103.000	1/4" NPT	35	Filter/Regulator w/ gauge (20 micron)	150 psi (10.2 bar)	0 - 125 psi (0 - 8.6 bar)	020.049.004	020.049.002	020.049.007	020.101.000	020.113.000
020.104.000	1/2" NPT	80	Filter/Regulator w/ gauge (40 micron)	150 psi (10.2 bar)	0 - 125 psi (0 - 8.6 bar)	020.050.004	020.050.002	020.050.007	020.101.000	020.114.000
020.105.000	3/4" NPT	150	Filter/Regulator w/ gauge (40 micron)	150 psi (10.2 bar)	0 - 125 psi (0 - 8.6 bar)	020.051.004	020.051.002	020.051.007	020.102.000	020.115.000
020.106.000	1" NPT	250	Filter/Regulator w/ gauge & mounting bracket kit (40 micron)	175 psi (12.1 bar)	0 - 125 psi (0 - 8.6 bar)	020.052.004	020.052.002	020.052.007	020.102.000	020.116.000
020.107.000 for AirVantage	1" NPT	250	Filter/Regulator w/ gauge & mounting bracket kit (20 micron)	175 psi (12.1 bar)	0 - 125 psi (0 - 8.6 bar)	020.070.004	020.052.002	020.052.007	020.102.000	Not Recommended

Temperature Ratings: 40°F to 125°F (4.4°C to 52°C).

# TRANQUILIZERS®

PULSATION DAMPENERS / SURGE SUPPRESSORS

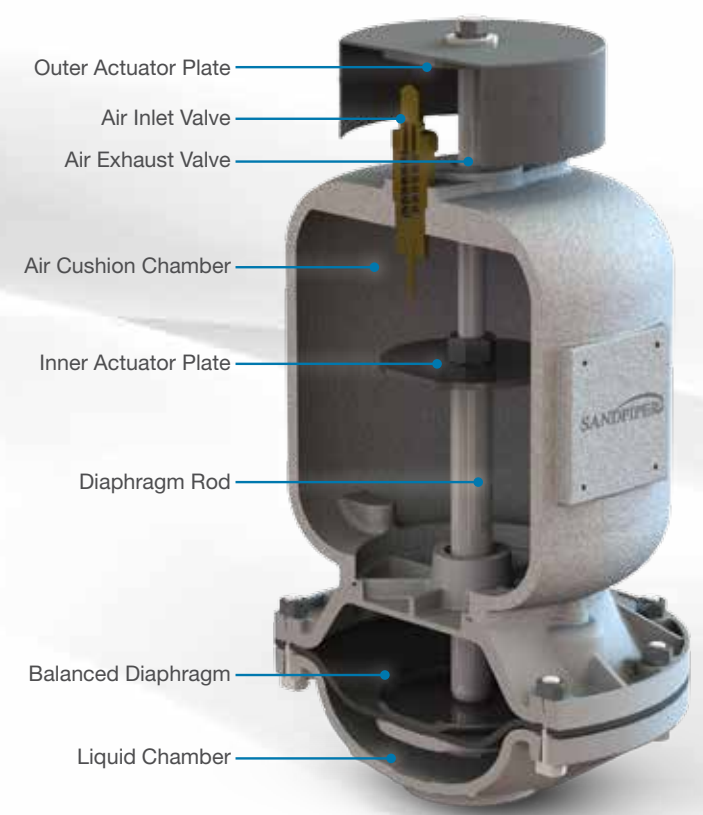

- Virtually surge-free flows**
- Steadier pressures**
- Less vibration and noise**
- Simple installation**
- Automatically self-charging and self-venting**
- Longest life balanced diaphragm**
- Capable of pressures to 125 PSI (8.6 BAR)**
- Protects other system components**



ALSO AVAILABLE THROUGH SANDPIPER:

**BLACOH**  
FLUID CONTROL  
Dampeners & Inlet Stabilizers  
Designed for 1", 2" & 3" Pumps

SCAN TO LEARN MORE  
SANDPIPERPUMP.COM/SURGEDAMPENERS



TECHNICAL SPECIFICATIONS							Available Wetted Materials										
Model	Desc.	Cert.	Air Inlet Size	Liquid Inlet Size	Height (mm)	Diameter (mm)	Chamber				Diaphragm						
							Aluminum	Stainless Steel	Cast Iron	Alloy C	Neoprene	Nitrile	FKM	EPDM	Neoprene PTFE Overlay	Santoprene®	
Tranquilizers (Featured Above)	TA1	1" pumps	1/4" NPT (external thread)	1" NPT	13.625"-15.125" (346mm-384mm)	9" (229mm) NPT(F)	✓	✓	✗	✗	✓	✓	✓	✓	✓	✓	✓
	TA25	1" pumps	1/4" NPT (external thread)	1" BSP (Tapered internal thread)	13.625"-15.125" (346mm-384mm)	9" (229mm) NPT(F)	✓	✓	✗	✗	✓	✓	✓	✓	✓	✓	✓
	TA1 1/2	1" & 1 1/2" pumps	1/4" NPT (external thread)	1 1/2" NPT (internal thread)	19.875"-21.325" (505mm-543mm)	10.5" (267mm) NPT(F)	✓	✓	✓	✓	✓	✓	✓	✓	✓	✓	✓
	TA40	1" & 1 1/2" pumps	1/4" NPT (external thread)	1 1/2" BSP (Tapered internal thread)	19.875"-21.325" (505mm-543mm)	10.5" (267mm) NPT(F)	✓	✓	✓	✓	✓	✓	✓	✓	✓	✓	✓
	TA2	1 1/2" & 2" pumps	1/4" NPT (external thread)	2" NPT (internal thread)	20.25"-23.1875" (514mm-589mm)	12.5" (317mm) NPT(F)	✓	✓	✓	✓	✓	✓	✓	✓	✓	✓	✓
	TA50	1 1/2" & 2" pumps	1/4" NPT (external thread)	2" BSP (Tapered internal thread)	20.25"-23.1875" (514mm-589mm)	12.5" (317mm) NPT(F)	✓	✓	✓	✓	✓	✓	✓	✓	✓	✓	✓
Dampeners	TA3	3" pumps	1/4" NPT (external thread)	3" 150# ANSI or 3" NPT (internal)	20.125"-23.125" (511mm-587mm)	16.1875" (411mm) NPT(F)	✓	✓	✓	✗	✓	✓	✓	✓	✓	✓	✓
	TA80	3" pumps	1/4" NPT (external thread)	3" BSP (Tapered int.) or 80mm DIN	20.125"-23.125" (511mm-587mm)	16.1875" (411mm) NPT(F)	✓	✓	✓	✗	✓	✓	✓	✓	✓	✓	✓
	DA05	1/2" pumps	CE	1/4" NPT	7.468" (190mm) WIDTH: 5.625" (143mm)	6.9375" (176mm)	Aluminum, Stainless Steel & Polypropylene										
	DA07	3/4" pumps	CE	1/4" NPT	7.718" (196mm) WIDTH: 5.625" (143mm)	6.9375" (176mm)	Polypropylene only										
DA10	1" pumps	CE	1/4" NPT	11.718" (298mm) WIDTH: 5.625" (143mm)	7.5" (191mm)	Polypropylene only											

✓ = Available ✗ = Not available

All of the TA models are CE and ATEX • Dimensional Tolerance: ±1/8" (±3mm). • See service manual for complete specifications.

# LIQUID LEVEL CONTROL

AUTOMATIC, FLOAT ACTUATED UNIT THAT OPENS AND CLOSES AIR SUPPLY TO YOUR AODD PUMP

## How it Works

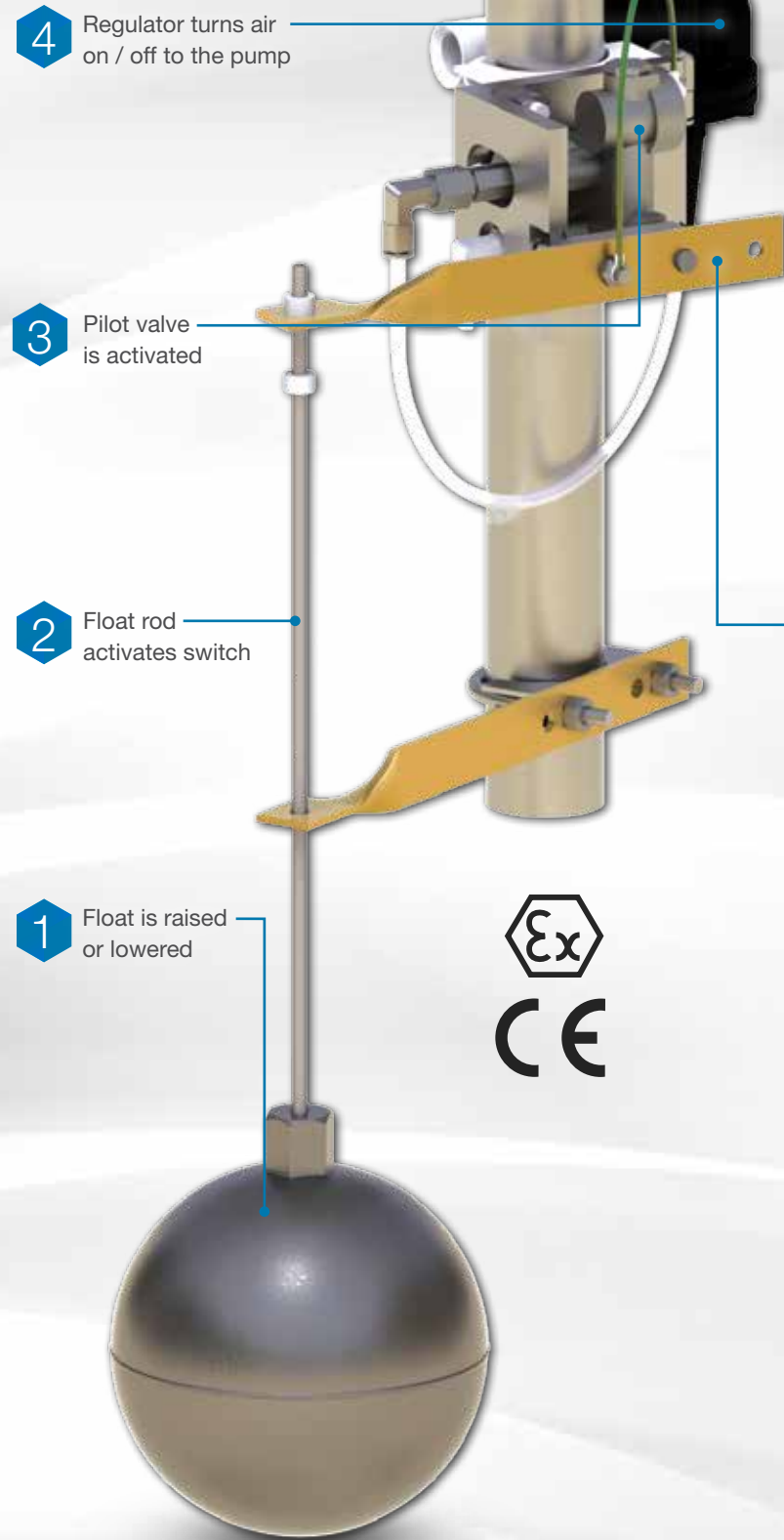

- Pneumatic**  
No electrical power required
- Adjustable**  
Operating range from a few inches to 9 ft (2.7 m)
- Simple**  
Easy to install & operate
- Versatile**  
Quick reversible operation
- Universal**  
Can be used with all AODD pumps
- Reliable**  
Stainless steel float & connecting rod

## Reversible Operation

Operation can be reversed by installing the top float rod bracket in the opposite direction from position shown.

### Standard Operation

High Level = On, Low Level = Off

### Reverse Operation

High Level = Off, Low Level = On

## Common Applications



Sumps



Dewatering



Fluid Transfer



Tank Filling



# ADDITIONAL ACCESSORIES

OTHER ACCESSORIES THAT SANDPIPER OFFERS TO HELP COMPLETE YOUR PROCESS



The **ONLY** CSA Certified point-of-use natural gas regulators available on the market today!

A safety port has been added to help prevent escaping gas in the case of a regulator diaphragm rupture. Simply add a pipe or hose fitting to the unit to divert or reclaim any natural gas.

SANDPIPER Natural Gas Pressure Regulators are safe, reliable and environmentally friendly. These exclusive CSA Certified and UL Listed point-of-use regulators provide superior regulation and excellent stability. All regulators include a durable glycerin filled pressure gauge to dampen the effects of pulsation and vibration common in pump applications.

## TECHNICAL SPECIFICATIONS

Part Number	Port Size	Max Flow (SCFM)	Pump Models	Max Inlet Pressure	Regulating Pressure Range	Temperature Rating	Materials of Construction
020.057.000	1/4" NPT	25	G05	250 PSI (17.2 BAR)	0 - 120 PSI (0 - 8.3 BAR)	0°F - 160°F (-17.8°C - 71.1°C)	Aluminum, Brass, Plated Steel, Nitrile
020.058.000	1/2" NPT	110	G1F, G10F	400 PSI (27.6 BAR)	0 - 125 PSI (0 - 8.6 BAR)	-40°F - 200°F (-40.0°C - 93.3°C)	Zinc, Aluminum, Plated Steel, Nitrile, Brass
020.059.000	3/4" NPT	110	G15, G20	400 PSI (27.6 BAR)	0 - 125 PSI (0 - 8.6 BAR)	-40°F - 200°F (-40.0°C - 93.3°C)	Zinc, Aluminum, Plated Steel, Nitrile, Brass
020.060.000	3/4" NPT	260	G20F, G30	400 PSI (27.6 BAR)	0 - 125 PSI (0 - 8.6 BAR)	-40°F - 200°F (-40.0°C - 93.3°C)	Zinc, Aluminum, Plated Steel, Nitrile, Brass

Diaphragm Material: Nitrile elastomer with polyester fabric  
All gauge ports & vent ports are tapped 1/4" NPT  
Replacement pressure gauge part number: 020.061.000

Note: The use of a relief valve is recommended for these products in accordance with NFPA 58.

## Natural Gas Filters

SANDPIPER Natural Gas Filters provide superior particulate protection from systems with high concentrations of solid contaminants. These point-of-use filters are built from durable and lightweight aluminum, feature very high dirt-holding capacity and offer lower pressure drop than other comparable products.

## TECHNICAL SPECIFICATIONS

Part Number	Port Size	Max Flow (SCFM)	Pump Models	Replacement Filter Element	Max Inlet Pressure	Max Temperature	Materials of Construction
020.062.000	1/4" NPT	25	G05	020.065.000			Aluminum Housing, Nitrile Seals, Molded Urethane End Seals
020.063.000	1/2" NPT	42	G1F	020.065.000	500 PSI (34 BAR)	175°F (80°C)	Aluminum Housing, Nitrile Seals, Molded Urethane End Seals
020.064.000	3/4" NPT	133	G10F, G15, G20, G20F, G30	020.066.000			Aluminum Housing, Nitrile Seals, Molded Urethane End Seals

Stainless Steel manual drain 1/8" NPT  
Micron Rating: 3



# DIAPHRAGM SELECTION

GET THE MAXIMUM LONGEVITY OUT OF YOUR SANDPIPER PUMP BY SELECTING THE APPROPRIATE DIAPHRAGM FOR YOUR APPLICATION

## The Synthesis Diaphragm

A premium one-piece diaphragm that creates optimum conditions for high performance pumping and reliability. Expect longer service life and reduced maintenance costs with this premium diaphragm.

**Temperature Range**  
14°F to 176°F (-10°C to 80°C)

**Torque-Free Installation**  
Simply hand turned into position

**No Center Hole** for superior leak free operation and installation

**No Outer Diaphragm Plate Abrasion** due to trapped fluids

**Oversized Integrated Plate** supports nearly 50% of the diaphragm through the entire dynamic motion

**Start-Up Pressure** of less than 10 PSI on SANDPIPER Synthesis Diaphragm vs. 25 PSI or more on competitive diaphragms

**One-Piece Composite Design** with 100% PTFE on the wetted side bonded to a Nitrile Rubber Backer (NRB) with an integrated diaphragm plate

## Two-piece Diaphragm

The standard PTFE diaphragm offered with SANDPIPER pumps is the two-piece diaphragm—a cost effective solution for a large variety of pumping applications. Some of the main features of this diaphragm include:

- Wide range of pressure capabilities
- Variety of materials available
- Proven performance over years of testing

Please consult your distributor or factory experts for additional details.

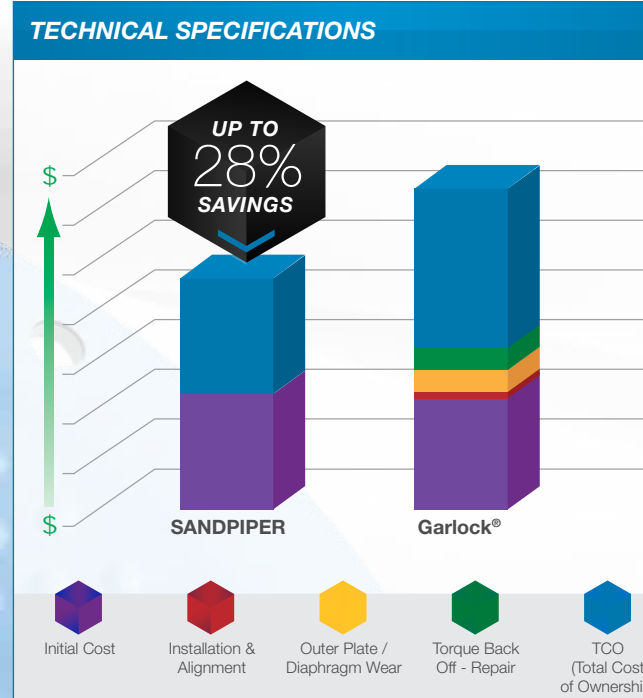

### TECHNICAL SPECIFICATIONS

Part Number (Conversion Kit)*	Inner Diaphragm Plate**	Where Used	Wet End Kit	Where Used
286.112.000 (475.250.000)	612.218.330	SB1	476.034.659	SB1-A
286.112.000 (475.250.000)	612.218.330	S1F Metallic	476.194.659	S1F Metallic
286.113.000 (475.254.000)	612.217.150	S15 Metallic	476.182.659	S15 Metallic
286.114.000 (475.255.000)	612.219.150	HDB1½	476.036.659	HDB1½
286.114.000 (475.256.000)	612.227.150	S15 Non-Metallic	476.255.659	S15 Non-Metallic
286.114.000 (475.256.000)	612.227.150	S20 Non-Metallic	476.257.659	S20 Non-Metallic
286.115.000 (475.258.000)	612.220.150	S1F Non-Metallic	476.197.659	S1F Non-Metallic
286.116.000 (475.251.000)	612.221.330	S05, S07, S10 Non-Metallic	476.202.659	S05 Non-Metallic
286.116.000 (475.251.000)	612.221.330	S05 Metallic	476.199.659	S05 Metallic
286.118.000 (475.252.000)	612.215.330	HDB2	476.043.659	HDB2
286.118.000 (475.253.000)	612.214.150	S20 Metallic	476.042.659	S20 Metallic

\*Conversion Kits include (2) Diaphragms w/Studs and (2) Inner Plates.  
\*\*Order this Inner Diaphragm Plate when ordering the One-Piece Diaphragm.

### MATERIAL SELECTION GUIDE

Diaphragm Material	Purchase Price	Flex Life	Abrasion Resistance	Chemical Resistance	Temp. Limitations	Temp. Max. Operating	Temp. Min. Operating
EPDM	✓	✓	✓	✓	+	280°F / 138°C	-40°F / -40°C
FKM	!	X	!	+	+	350°F / 177°C	-40°F / -40°C
Hytrel®	✓	+	+	✓	✓	220°F / 104°C	-20°F / -29°C
Neoprene	+	+	✓	X	✓	200°F / 93°C	-10°F / -23°C
Nitrile	+	+	✓	!	✓	190°F / 88°C	-10°F / -23°C
Santoprene®	+	+	+	+	+	275°F/135°C	-40°F/-40°C
Urethane	+	✓	!	X	!	150°F / 66°C	32°F / 0°C
PTFE Synthesis	!	✓	!	+	!	176°F / 80°C	14°F / -10°C
PTFE Two-Piece	!	!	X	+	✓	220°F / 104°C	-35°F / -37°C

For reference only, consult distributor.

+ = Best Type    ✓ = Suitable    ! = Limitations    X = Not Recommended

Santoprene® is a registered trademark of Exxon Mobil Corp. Hytrel® is a registered trademark of E.I. DuPont.

## GENUINE PARTS SERVICE KITS

SANDPIPER HAS A SOLUTION WHETHER YOUR AODD PUMP NEEDS QUICK, URGENT CARE OR A FULL SERVICE REPAIR

Repair it Once, Repair it Right

**Everything in One Place**  
All of the parts you need to get running again

**Reduce Frequency of Repairs**  
Reliable replacement parts are guaranteed to last

**Increase Uptime**  
Maximize your productivity with fewer repairs

**Save Time and Money**  
Ordering and repairs made easy

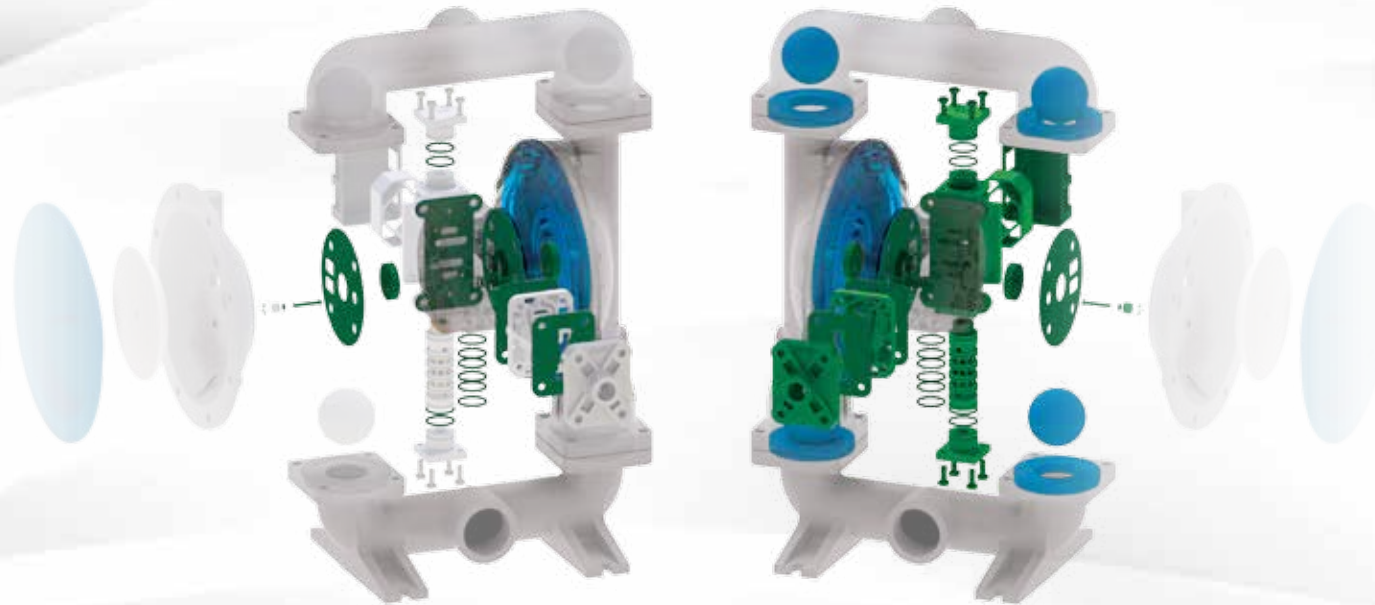

### Wear Kits

#### Wet End Wear Kit:

- Diaphragms

#### Air End Wear Kit:

- Gaskets
- O-rings
- Seals
- Lubricant

### Repair Kits

#### Wet End Repair Kit:

- Diaphragms
- Balls
- Seats

#### Air End Repair Kit:

- Seals
- O-rings
- Gaskets
- Retaining Rings
- Air Valve Sleeve & Spool
- Pilot Valve Assembly
- Lubricant

**SANDPIPER®**  
GENUINE PARTS

SANDPIPER is pleased to offer you the trusted Genuine Parts you need, sold in convenient kits or individual parts. Whatever you need to make pump repairs, we have you covered.

#### USE ONLY GENUINE SANDPIPER PARTS

All certification, standards, guarantees & warranties originally supplied with this pump will be invalidated by the use of service parts not identified as "Genuine SANDPIPER Parts."



## SANDPIPER'S EXTERNALLY SERVICEABLE AIR DISTRIBUTION SYSTEM (ESADS+PLUS)

SANDPIPER's Externally Serviceable Air Distribution System (ESADS) allows for quick and easy access to the pilot and spool valves without removing the pump from service, maximizing up time!

### SANDPIPER

VS

### COMPETITORS



The Air Motor's Pilot Valve is the Most Often Serviced Part on an AODD Pump



**5 MINUTES FOR MAINTENANCE / CLEANING**  
Accomplished in minutes without removing pump from service by removing only 4 bolts



Saves you money by minimizing downtime



**55 MINUTES OR LONGER FOR MAINTENANCE / CLEANING**  
The air valve components can only be accessed by removing the pump from service and taking it entirely apart



Costs you money due to extended downtime

# SANDPIPER



# COMPETITION

## HEAVY DUTY FLAP VALVE PUMP

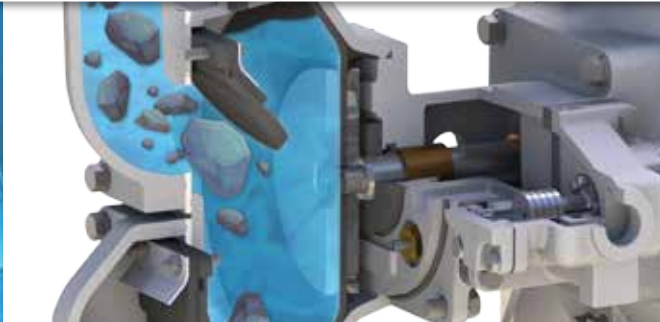

Large solids easily pass through pump

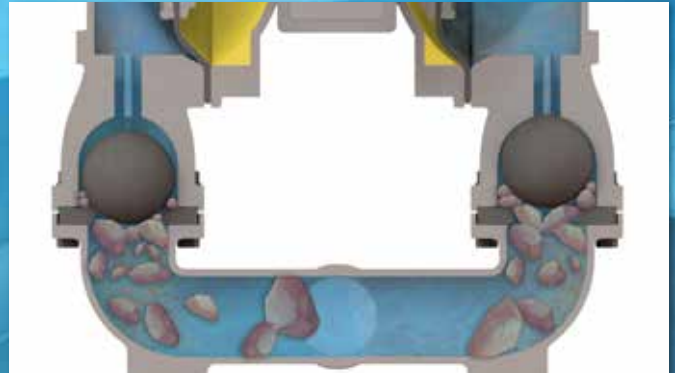

Large solids cannot pass through pump, affecting operation

## HEAVY DUTY BALL VALVE PUMP

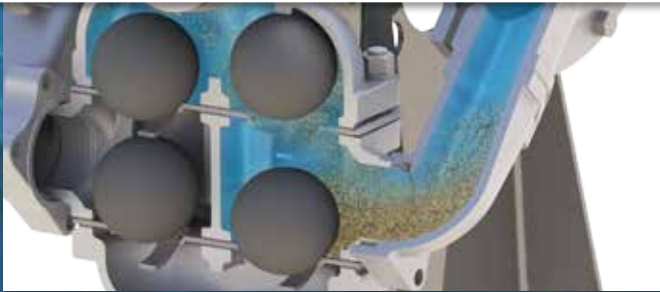

Settling solids easily pass through pump

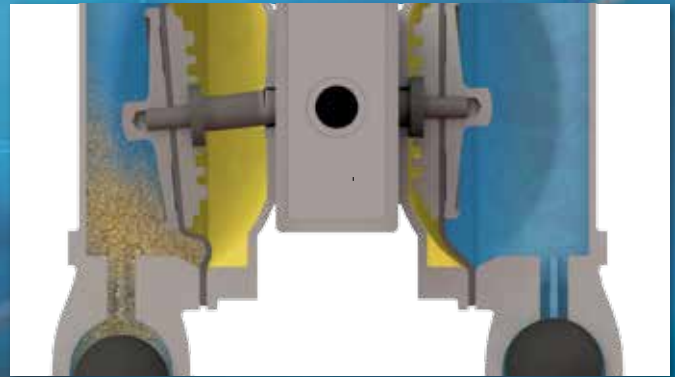

Settling solids collect inside pump, causing damage & affecting operation

## CONTAINMENT DUTY PUMP

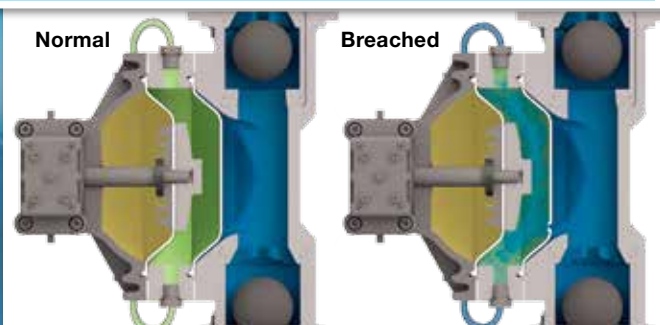

Contains fluid when diaphragm becomes breached

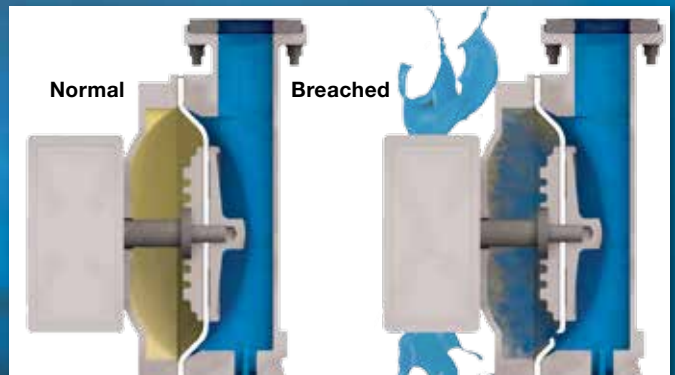

Fluid escapes to environment when diaphragm becomes breached.



Warren Rupp, Inc. | A Unit of IDEX Corporation  
800 North Main Street, Mansfield, OH 44902 USA  
Phone: 419.524.8388 | Fax: 419.522.7867  
[SANDPIPERPUMP.COM](http://SANDPIPERPUMP.COM)



Contact Your Local Distributor to Place Your Order: