



*fluidity.*  
**nonstop**

IT'S ABOUT KEEPING YOUR PROCESSES RUNNING



**Pharmaceutical**

 **AXFLOW**

## About AxFlow

Part of Axel Johnson AB with sales of over 7 billion euro and 20,000 employees worldwide, the AxFlow group is one of Europe's largest suppliers of process pumps with offices a presence in 28 European countries, South Africa, Australia and New Zealand.



*fluidity.*  
**nonstop**

IT'S ABOUT KEEPING YOUR PROCESSES RUNNING



AxFlow has developed *fluidity.nonstop* a concept through which we provide products and services that encompass all aspects connected with the smooth running of process pumps.

# AxFlow in Great Britain

In the UK, AxFlow has over 65 years history and operates from 5 locations across the country from which we supply a multitude of process pumps and a range of pump service and repair packages.

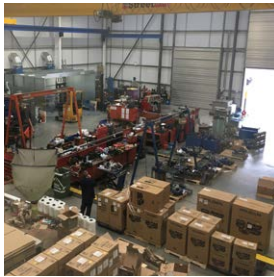
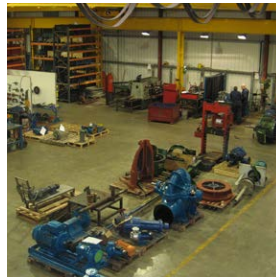

AxFlow is the largest supplier of positive displacement pumps in the UK and is a key player in the provision of pump and pump related products to the UK Food & Beverage Production Industry. Our range of hygienic pump products includes; AODD, centrifugal, rotary lobe, rotary circumferential piston, eccentric disc and vane pumps.



## Installation

We can install and commission your pumps to ensure they work properly from the word “go” and identify any issues with your system that may adversely affect the pump.

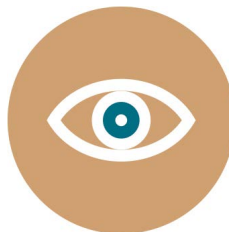

## Monitoring

We can monitor your pumps to check they’re working OK by performing regular checks or can foresee problems and carry out planned maintenance work, therefore preventing pump failures and process stoppages.



## Repair

We can undertake numerous types of work on-site or at one of our Service Centres. This work can range from simple maintenance, to completely rebuilding your pump by recreating key components.

# The most comprehensive portfolio of hygienic pumps in the UK

With our recently expanded centrifugal pump range and our already comprehensive array of positive displacement pumps, AxFlow now offer the largest range of pumps suitable for hygienic applications in the UK.

## > Waukesha Cherry-Burrell

Now part of SPX, Waukesha Cherry-Burrell has a long history in the food, dairy, beverage and industrial process industries. Known for its exceptional quality and precision made products.



Wilden is one of the world's largest manufacturers of air operated double diaphragm pumps. Within Europe, Wilden has a history with AxFlow that goes back more than 40 years that has resulted in AxFlow developing a deep knowledge of their products and large stocks held at our European Distribution Centre.

## Gruppo Aturia

The oldest pump manufacturer in Italy tracing its routes back to 1889, Gruppo Aturia employs over 250 people at its four manufacturing facilities in Italy, France and Switzerland. The group manufactures pumps for the utilities, process, nuclear and oil/gas sectors.

## WARMAN PUMPS

Part of the Weir group, Warman Pumps are based in France and has specialised in solid handling pumps since 1953. Their product range is centred around the use of unique vortex impellers and abrasion resistant materials that allow their pumps to transfer solid laden and abrasive liquids.



Movex, was founded in 1906 and is a leading manufacturer of positive displacement pumps. They have become experts in the manufacture of eccentric rotating and vane pumps for the food industry.



Pulsafeeder has been a leader in fluid handling technology since the early 1940's, they pioneered the hydraulically actuated diaphragm metering pump principle and are world leaders in magnetically driven gear pumps.



Part of SPX, APV is a world recognised brand leader in the manufacture of hygienic products for the Food and Beverage Industry. AxFlow are the exclusive UK distributor for their pumps, heat exchangers, valves and homogenisers.



Realax is a major force in the fluid handling industry. Bringing a new comprehensive range of Peristaltic pumps for handling an extraordinary range of media and drawing on vast industry and application experience.



Blackmer is the world's leading manufacturer of rotary-vane pumps. Blackmer's unique sliding-vane design is now recognised world-wide for handling industrial process fluids, abrasive slurries and viscous liquids.



Hidrostal are the world leaders in screw centrifugal pumps having originated the design in the 1950's. AxFlow are the official UK partner for non-water industry applications.



First established in 1984, Almatec has become the respected world leader in the field of pneumatic diaphragm pumps due to a combination of consistent innovation and German product quality.



Part of IDEX, OBL has one of the largest metering pump portfolios including plunger, mechanical diaphragm and hydraulic diaphragm types.

# Range Summary

		Hygienic Standards			ATEX	Solids	CIP	Max	Max Diff	Max	Max	Min	Max	Page
		FDA	EHEDGE	3-A				m3/hr	Pressure	System bar	°C	°C	cP	
<b>AODD Pumps</b>														
FDA Saniflo	Wilden							40	8 bar	8	176	0	20,000	6
HS Saniflo	Wilden							40	8 bar	8	176	0	20,000	6
Biocor	Alamtec							18	70 bar	7	176	-10	10,000	7
<b>Lobe Pumps</b>														
DW	APV							376	30 bar	30	180	-10	700	8
Universal 1	Waukesha							190	14 bar	14	149	-40	200,000	8
Universal 2	Waukesha							100	35 bar	35	148	-40	1,000,000	9
Universal 3	Waukesha							100	35 bar	35	148	-40	1,000,000	9
<b>Screw Pumps</b>														
Twin Screw	Waukesha							270	25 bar	25	149	-40	500,000	10
<b>Vane Pumps</b>														
NP-SNP-HXL	Blackmer							250	140 bar	20	260	-20	22,000	11
P Series	Blackmer							100	12 bar	14	250	-5	22,000	11
SVM	Aturia							2	13 bar	350	300	-50	200	
<b>Peristaltic Pumps</b>														
APY	Realax							0.09	2 bar	2	100	-20	10,000	12
ISI	Realax							1.5	8 bar	8	120	-20	25,000	13
IP	Realax							25	8 bar	8	120	-20	25,000	13
RP	Realax							50	15 bar	15	120	-20	25,000	13
<b>Eccentric Disc Pumps</b>														
S Series	Mouvex							12	10 bar	10	80	0	3,000	14
C - SLS Series	Mouvex							8	16 bar	16	80	0	3,000	14
<b>Centrifugal Pumps</b>														
ND	Aturia							1700	140 m	16	300	-20	300	15
NDM	Aturia							200	100 m	25	300	-50	300	15
C Series	Waukesha							190	90 m	10	100	-10	200	16
W+ Series	Waukesha							600	150 m	15	200	-10	500	17
AquaFit	Aturia							300	100 m	10	140	-5	100	18
AquaLine	Aturia							300	60 m	10	140	-5	100	18
NA	Aturia							700	100 m	10	140	-5	100	18
NE	Aturia							700	100 m	10	140	-5	100	18
TK-VTK-VRK	Aturia							800	900 m	90	140	-5	100	19
PD	Aturia							700	100 m	10	140	-5	100	19
Type A - F - MC	Warman							2000	42 m	10	80	-5	150	20
End Suction	Hidtrostal							9000	100	10	150	-20	4000	21
Submersible	Hidtrostal							9000	100	10	150	-20	4000	21
SDM	Aturia							27	20 m	25	200	-50	150	22
STM	Aturia							10	90 m	100	350	-50	150	22
<b>Metering Pumps</b>														
MD/ML	OBL							2	12 bar	12	45	0	100	23
Plunger Pumps	OBL							10	400 bar	400	45	0	100	23
Hydraulic Diaphragms	OBL							3.8	125 bar	125	100	0	100	23
Pulsa	Pulsafeeder							18	250 bar	250	350	0	5,000	23
Pulsar	Pulsafeeder							0.6	250 bar	250	110	0	200	23
<b>Process Equipment</b>														
Plate Heat Exchangers														24-25
Scarped Surface Heat Exchangers														25
Homogenisers														26
Valves														27
Mixers														28
Shear pumps														29
Colloid Mills														29

Please note that all technical information is approximate, consult AxFlow GB before specifying any product.



AOD

## FDA SANIFLO

The Saniflo Series pump line is specifically designed for sanitary process requirements. Saniflo pumps incorporate a straight flow-through design, large solids passage and an internal, adjustable “Efficiency Management System” to maximise the pumps air efficiency.

- St Steel
- Buna
- EPDM
- Viton
- Neoprene
- Santoprene
- Hytrell
- Polyu'thane
- PTFE

- Solids
- Low Shear
- CIP
- Self Priming
- Corrosive Liquids
- Abrasive Liquids

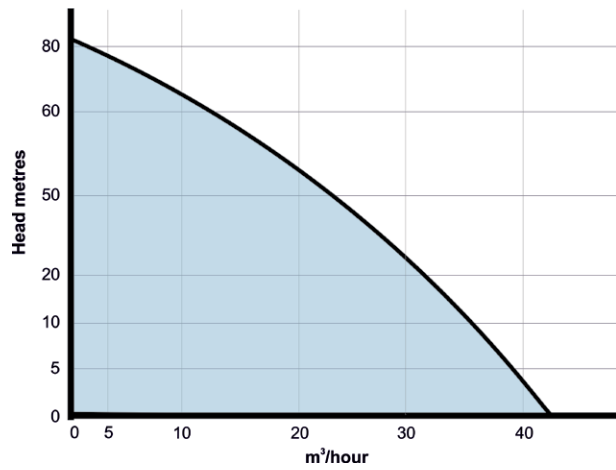

- Suitable for CIP.
- Available with Tri-Clamp fittings.
- Shear sensitive pumping action.
- Dry priming and dry running.
- Can be dead headed without damage.
- Will deliver variable flow and pressure.
- Sizes 1/2” to 3”.

## HS SANIFLO

The HS Saniflo Series pump range is an upgraded version of the Saniflo line. HS Saniflo pumps also incorporate a straight flow-through design, large solids passage and an internal and adjustable “Efficiency Management System”; but also a surface finish to 0.4 µ and higher levels of hygienic certification.

- St Steel
- Buna
- EPDM
- Viton
- Neoprene
- Santoprene
- Hytrell
- Polyu'thane
- PTFE

- Solids
- Low Shear
- CIP
- Self Priming
- Corrosive Liquids
- Abrasive Liquids

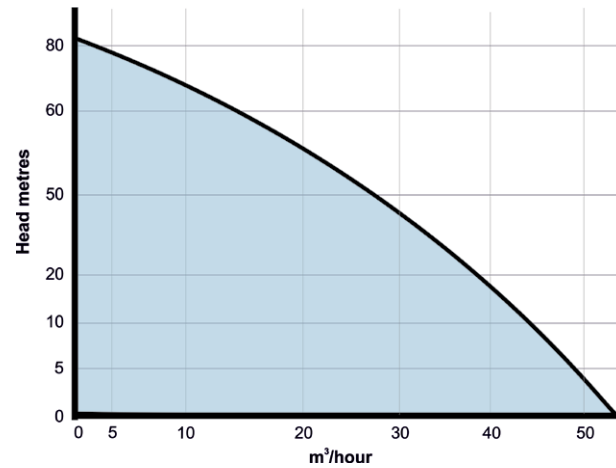
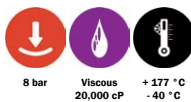

- Suitable for CIP.
- Available with Tri-Clamp fittings.
- Delicate shear sensitive pumping action.
- Dry priming and dry running.
- Can be dead headed without damage.
- Will deliver variable flow and pressure.
- Sizes 1” to 3”.
- Ball, mushroom, flap valves available.



AOD

## BIOCOR

Biocor pumps offer the very highest standard in sterile design and have no horizontal surfaces. Their ball valves are raised magnetically and the pumps can be drained without having to be dismantled. They offer surface finishes to 0.4 μ, high degrees of hygienic certification and a maintenance-free air control system without dead spots.

St Steel  
Polyethene



- ✓ Solids
- ✓ Low Shear
- ✓ CIP
- ✓ SIP
- ✓ Self Priming
- ✓ Corrosive Liquids
- ✓ Abrasive Liquids

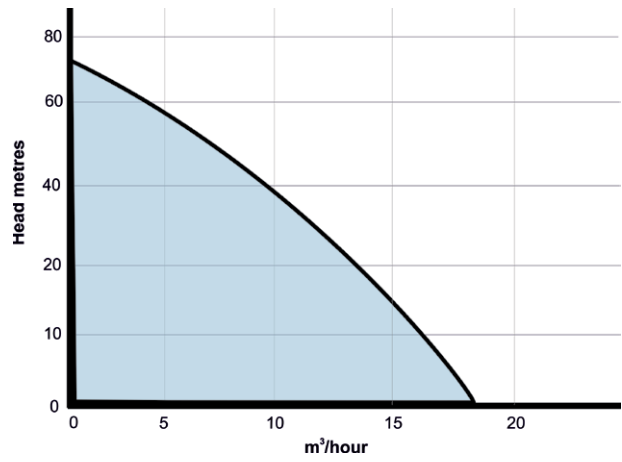

- Highly sterile design with option for liquid barrier.
- Suitable for CIP and SIP.
- Available with Tri-Clamp fittings.
- Delicate shear sensitive pumping action.
- Dry priming and dry running.
- Can be dead headed without damage.
- Will deliver variable flow and pressure.
- Sizes DN 20, 32 and 40.





## Rotary Lobe and ECP

### DW

The DW Lobe pump has been developed to handle applications where a simple lobe design can provide the solution. The new DW-range is designed with minimised internal clearances making the pump so efficient that in medium viscosity applications a smaller pump size than usual will do the job

St Steel  
Viton



- Solids
- Low Shear
- CIP
- Self Priming
- Corrosive Liquids
- Abrasive Liquids

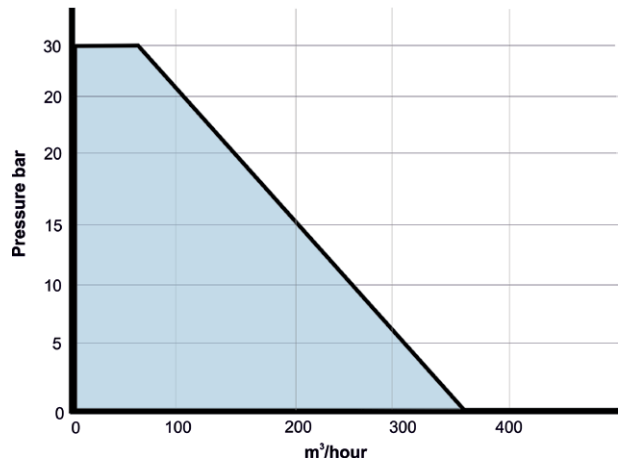

- Suitable for CIP.
- Low shear pumping action.
- Low NSPH requirement.
- All wetted parts 316L.
- Single and double mechanical seals, packed gland seals and triple lip seals.
- Front loaded mechanical seals.



### Universal 1

Built around Waukesha arc shaped rotor wings resulting in a long sealing path, the Universal 1 Series offers very low pump slippage, high discharge pressures and the ability to pump liquids with both high and low viscosity. They are also extremely easy to maintain and are known for their long service life.

St Steel  
Alloy 88  
EPDM  
Viton  
Silicone  
PTFE  
FEP  
Buna



- Solids
- Low Shear
- CIP
- SIP
- Self Priming
- Corrosive Liquids
- Abrasive Liquids

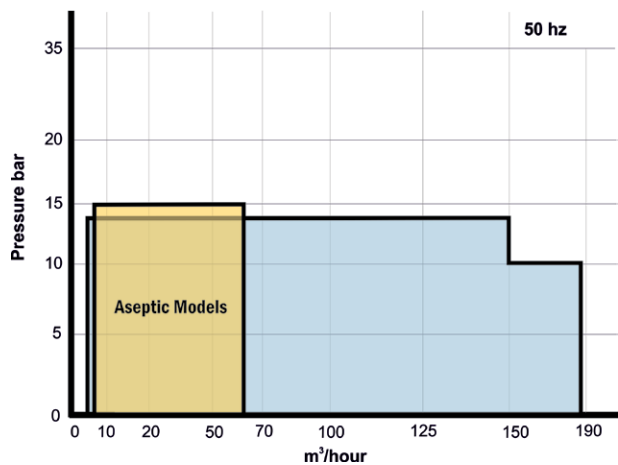

- Suitable for COP and aseptic applications.
- Bi-directional flow.
- Very sensitive pumping action.
- Free draining pump housing.
- Dry running with flushed seal.
- Can pump large solids.
- Non-galling Alloy 88 alloy rotors.
- Sizes 1" to 6".

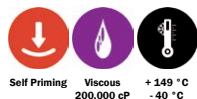





ECP

## Universal 2

Built around Waukesha arc shaped rotor wings resulting in a long sealing path, the Universal 2 Series offers the same low pump slippage, easy maintenance, low service life and the ability to pump liquids with both high and low viscosity as the Universal 1 but at higher flows, pressures and with a more hygienic design.

- St Steel
- EPDM
- Viton
- Silicone
- PTFE
- FEP
- Buna

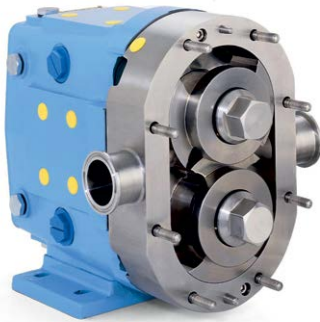

- Solids
- Low Shear
- CIP
- SIP
- Self Priming
- Corrosive Liquids
- Abrasive Liquids

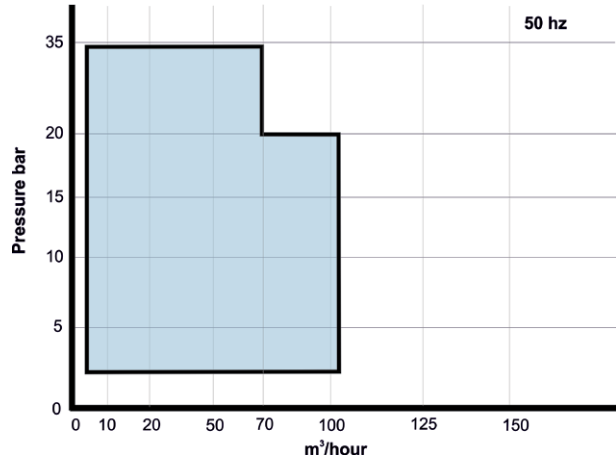

- Suitable for CIP and aseptic applications.
- Bi-directional flow.
- Very sensitive pumping action.
- Free draining pump housing.
- Dry running with flushed seal.
- Can pump large solids.
- Will deliver variable flow.
- Sizes 1" to 6"



## Universal 3

Built around Waukesha arc shaped rotor wings resulting in a long sealing path, the Universal 3 Series offers the same low pump slippage, easy maintenance, low service life and the ability to pump liquids with both high and low viscosity as the Universal 2 but an even a more hygienic design the option of lips seals and easier maintenance.

- Alloy 88
- St Steel
- EPDM
- Viton
- Silicone



- Solids
- Low Shear
- CIP
- SIP
- Self Priming
- Corrosive Liquids
- Abrasive Liquids

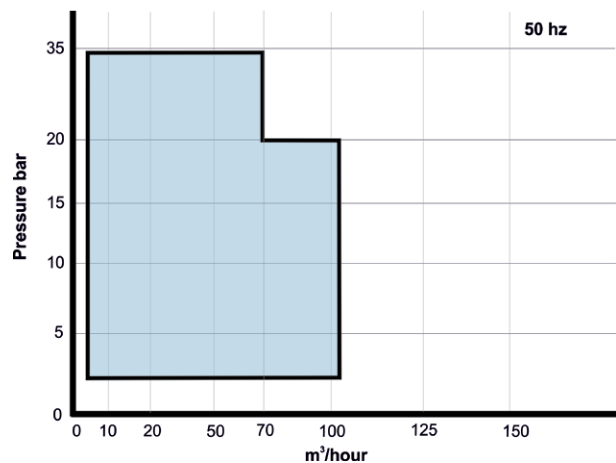

- Lip seals and mechanical seals.
- Front loading seals.
- Suitable for CIP and aseptic applications.
- Bi-directional flow.
- Very sensitive pumping action.
- Free draining pump housing.
- Dry running with flushed seal.
- Can pump large solids.





## Rotary Lobe and Piston

### Universal TS

The Waukesha Universal TS range is a new and innovative positive displacement twin screw pump for hygienic applications. This precision pump offers a gentle flow and the ability to pump both product and CIP therefore reducing overall process costs considerably.

- Cast Iron
- St Steel
- Duravane
- EC Laminate
- Bronze



- ✓ Solids
- ✓ Low Shear
- ✓ CIP
- ✓ SIP
- ✓ Self Priming
- ✓ Corrosive Liquids
- ✓ Abrasive Liquids

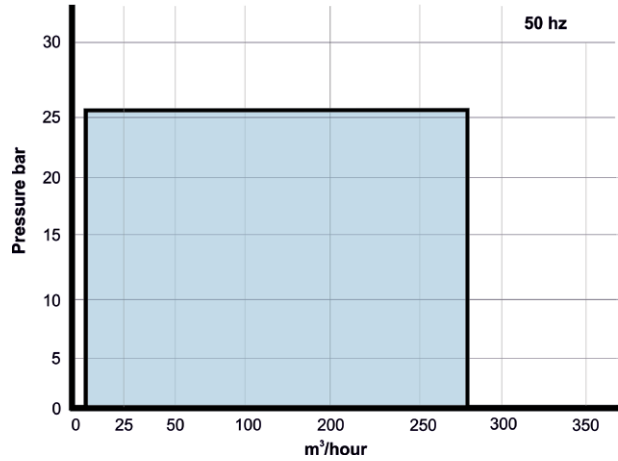

- Can be used to pump product and CIP.
- Waukesha Alloy 88 non-galling material reduces damage from solids.
- Gentle product handling.
- Easy front access to product side seals
- Instant bi-directional flow capability.
- Smooth operation - Reduces slip pulse in low inlet pressure, low viscosity, and high pressure conditions.

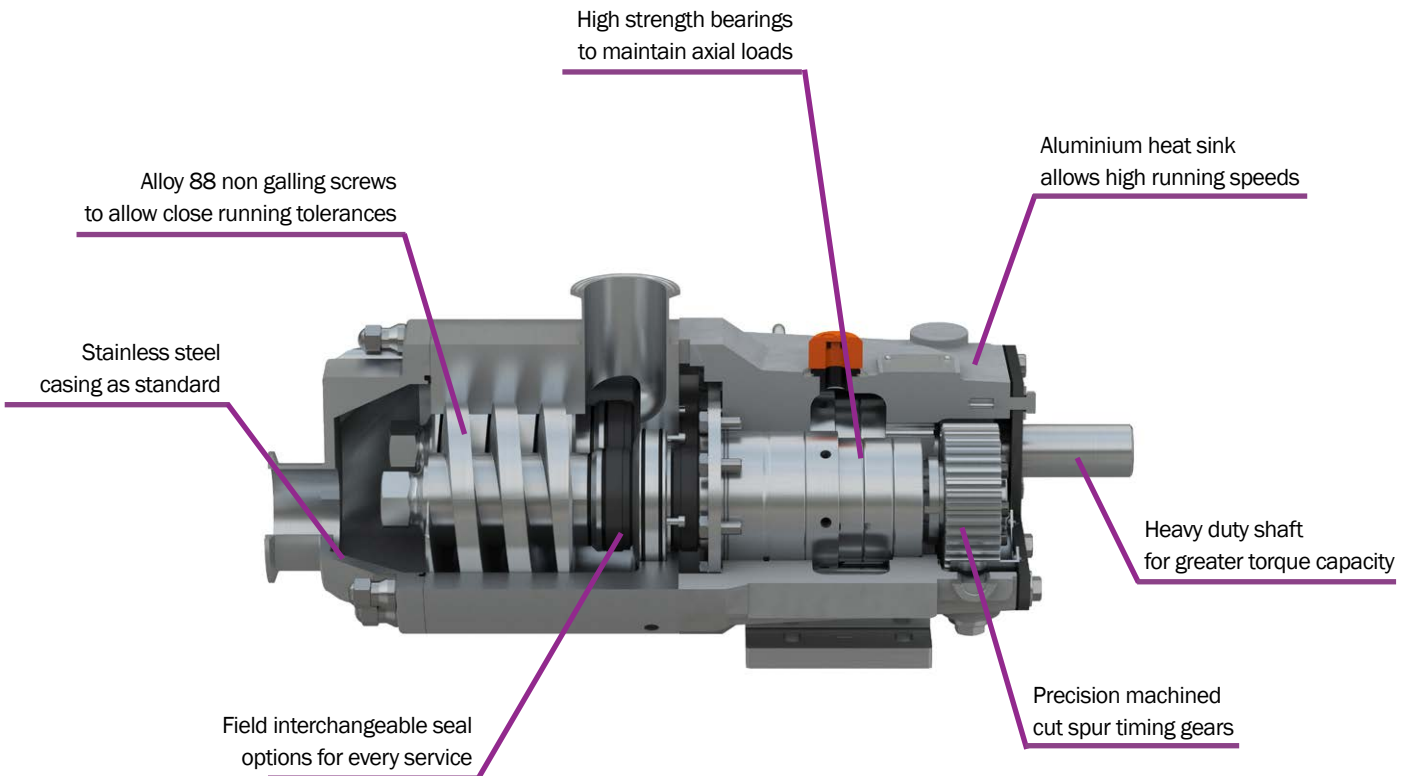

## THE UNIVERSAL TS - TWO PUMPS IN ONE



Vane

## NP - SNP Series

Blackmer NP pumps are specifically designed to offer maximum versatility for handling a wide variety of clean non-corrosive liquids. The NP pump is ideal for applications that have varying fluid viscosity's and temperatures. NP pumps can be fitted with double mechanical seals. SNP denotes stainless steel.

- Cast Iron
- St Steel
- Duravane
- EC Laminate
- Bronze
- Viton
- PTFE

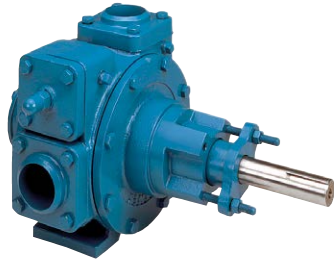

- Low Shear
- Self Priming
- Corrosive Liquids

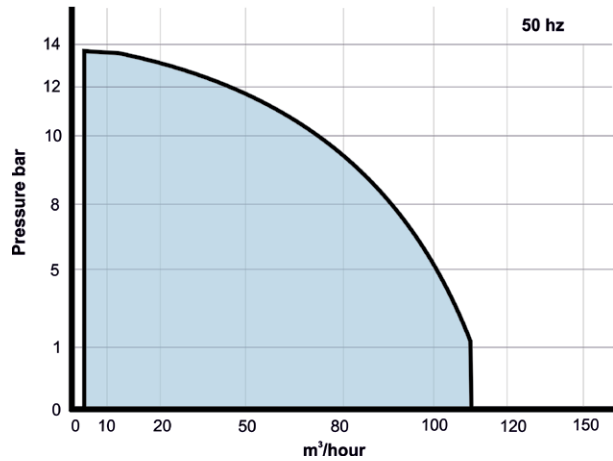

- Jacketed pump head available
- Excellent self-priming and dry run capabilities.
- Symmetrical bearing support assures even loading and wear for long life.
- Adjustable relief valve protects pump against excessive pressures.
- Vanes can be replaced without removing the pump from the piping system.

## P Series

The Mouvex P series vane pump P Series vane pumps cover a large range of applications, from fluid to very viscous products, whether they are non-lubricating, abrasive or corrosive they have proofed particularly successful use with chocolate products.

- St Steel
- Cast Iron
- Viton
- Nitrile



- Low Shear
- Self Priming

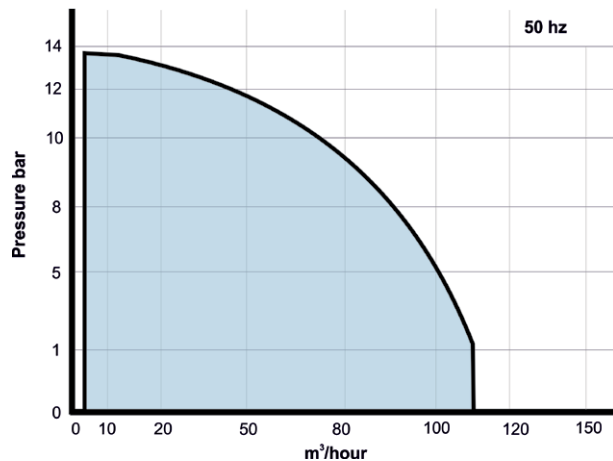

- Chocolate compatible.
- Performance remains constant over time.
- Dry-run capability.
- Can be supplied with built-in heating or cooling jackets.



Peristaltic

### APY

APY tube pumps are ideal for lower pressures and low flow applications providing accurate dosing of small quantities of up to 90 l/h and up to 2 bar pressure. The three roller design cuts vibration and tube replacement is quick and easy.

- Silicone
- Norprene
- Tygon
- Solva

- Abrasives
- Solids
- Low Shear
- Self Priming
- Corrosive Liquids

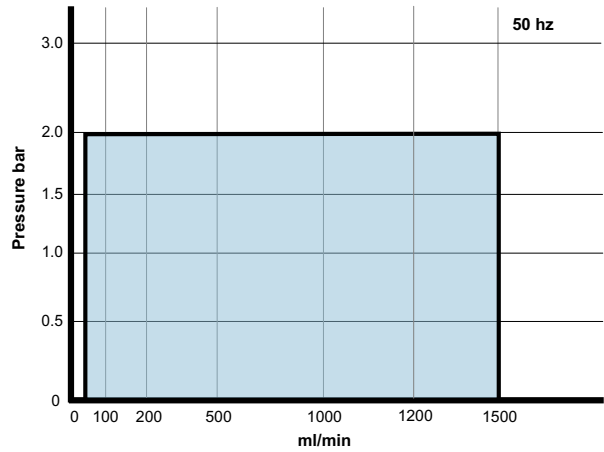

- Suction lift to 6 metres.
- Plastic baseplate with leakage container.
- Reversible rotation.
- High dosing accuracy.
- Corrosion resistant.
- Sanitary tubes to FDA.



### ISI

Competitively priced hose pumps with rollers for pressures up to 8 bar and flows of 1.5 m<sup>3</sup>/hr. ISI pumps can be fitted with an integrated VSD making them ideal as heavy duty dosing pumps.

- EPDM
- Silicone
- Norprene
- NR
- NBR
- HYPALON

- Abrasives
- Solids
- Low Shear
- Self Priming
- Corrosive Liquids

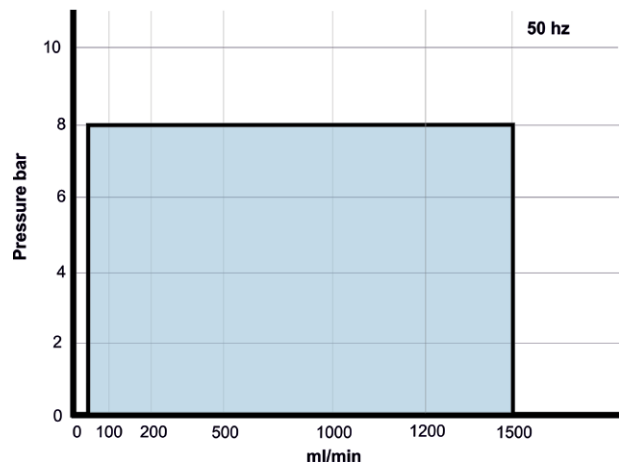

- Suction lift to 6 metres.
- Plastic baseplate with leakage container.
- Reversible rotation.
- Available with pulsation dampers.
- Corrosion resistant.
- Sanitary tubes to FDA.





Peristaltic

## IP - RP

IP and RP pumps are high specification hose pumps that utilise different constructions including either rollers or shoes depending upon the duty to offer the most cost effective solution while maximising the hose life.

- EPDM
- Silicone
- Norprene
- NR
- NBR
- HYPALON



- Abrasives
- Solids
- Low Shear
- Self Priming
- Corrosive Liquids

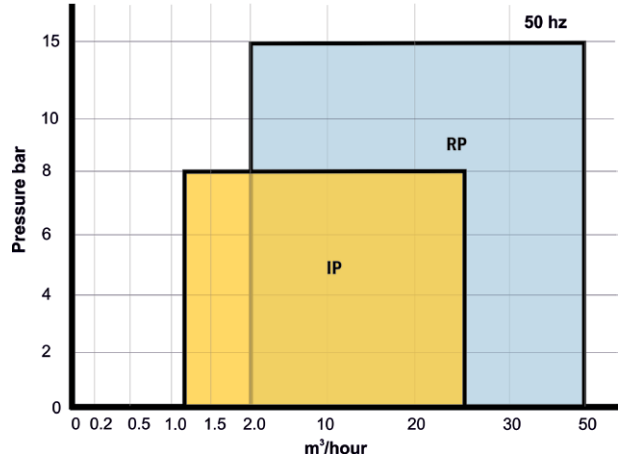

- Suction lift to 9 metres.
- Reversible rotation.
- Hose leakage detector available.
- Can be accompanied with pulsation dampeners.
- FDA materials available.
- Available with casing coated in Halar (PTFE).`



Patented four collar taper lock hose connection which is easy to fit and reusable.



Rollers

The IP range uses rollers which are up to twice the diameter of any other hose pump brand. This design generates less friction which prolongs the life of the hose and reduces power consumption.

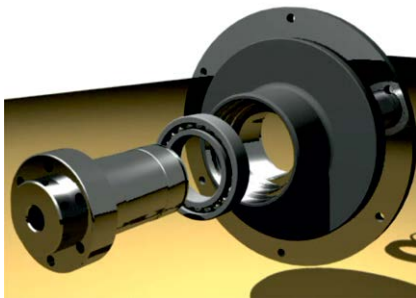

Unlike most hose pump brands, Realax IP and RP pumps feature an additional bearing between gear box and pump shaft that significantly reduces the load on the gear box bearing.



Shoes

Fixed shoes are used by RP models which move across the surface of the hose during compression. Shoes spread the pressure over a greater area and make a firmer seal than rollers. Typically they are preferred for higher operating pressures (above 8 bar) and more viscous liquids.



## Eccentric Disc

### S Series

S-Series pumps eliminate all leakage problems thanks to their direct drive seal-free design, no mechanical seals, packing or magnets. The transmission mechanism is protected by a high-resistance elastomer sleeve.

St Steel  
Viton  
FEP



- Solids
- Low Shear
- CIP
- SIP
- Self Priming

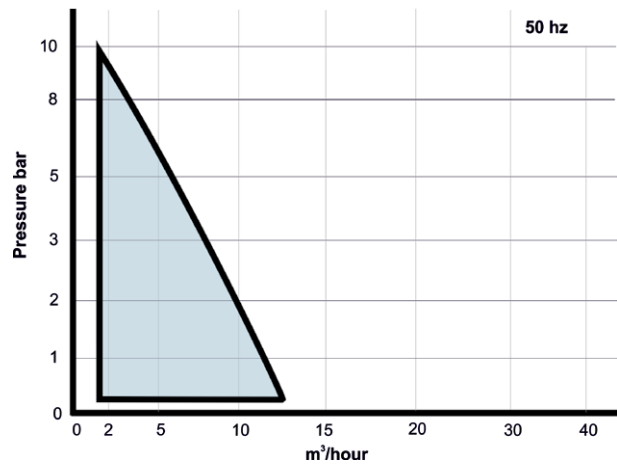

- Very accurate volume metering enabling precise dosing and mixing.
- CIP and SIP compatible.
- For viscous or fluid products.
- High-speed priming and self-priming.
- Pipe draining capability.
- Dry-run capability.
- Capability to clear the pipe.

### C & SLS Series

Shear sensitive materials are safe when pumped with the C-Series. The unique eccentric disc concept provides gentle handling and high-volume efficiency. The C-Series is designed to be flushed and cleaned in place without disassembly. The new SLS Series meets the requirements of EC 1935/2004.

St Steel  
Ductile iron  
Viton  
FEP



- Solids
- Low Shear
- CIP
- SIP
- Self Priming

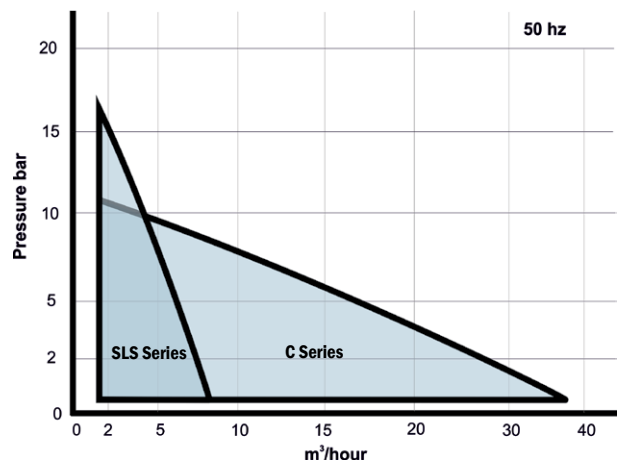

- Self priming.
- CIP Capability.
- Consistent performance over time due to automatic disc/cylinder adjustment.
- Can be flushed and CIPed without disassembly.
- Pumped product constantly renewed.
- Output not affected by viscosity variation
- Low linear speed.



## Centrifugal

### ND - ISO Pumps

High quality ISO 2858 - ISO 5199 process pumps refined over many years service life to offer an efficient and balanced pump design. Most components are stocked resulting in short lead times.

- St Steel
- Dup St St
- S Dup St St
- Hastelloy
- Titanium
- Carb St
- Monel

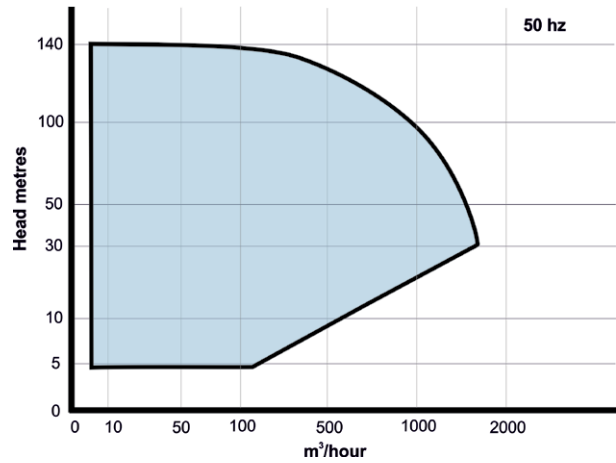
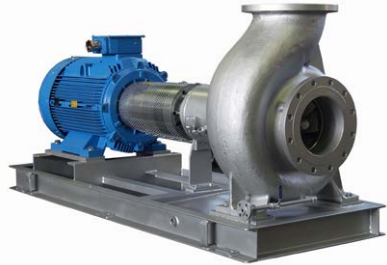

✓ Corrosive Liquids

- Dynamically balanced impellers.
- Oil lubricated ball bearings.
- Back pull out design.
- Labyrinth seals on bearing supports to negate external contamination.
- Single, double and flushed seals.
- Optional Refrigerated seal chamber.
- SS with DX or Hastelloy options.

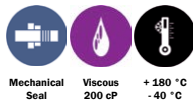

### NDM

High quality magnetically driven ISO 2858 pumps. NDM pumps have hydraulically and hydro-statically balance pump chambers and Hastelloy rear housings, Samarium Cobalt magnets and Silicon Carbide bears as standard. They are available as either a long or close coupled construction.

- St Steel
- Hastelloy
- Dup St St

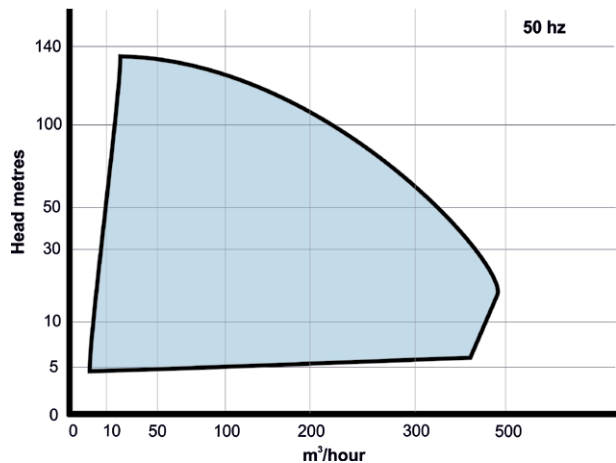

✓ Corrosive Liquids

- No mechanical seals to leak or service.
- Oil lubricated ball bearings.
- Incoloy or Hastelloy constructions available.
- Back pull out design with screw-on impeller.
- Available with self cleaning filters.





## Centrifugal

### C Series

The C Series is our standard range of hygienic transfer and CIP pumps for liquids up to 200 cP. They offer a versatile performance at competitive prices and are suitable for most hygienic centrifugal pump applications. They can be installed without fear of seal failure from elevated inlet pressures, even with viscous products.

- St Steel
- Buna
- Viton
- EPDM



- Solids
- CIP
- Self Priming
- Corrosive Liquids
- Abrasive Liquids

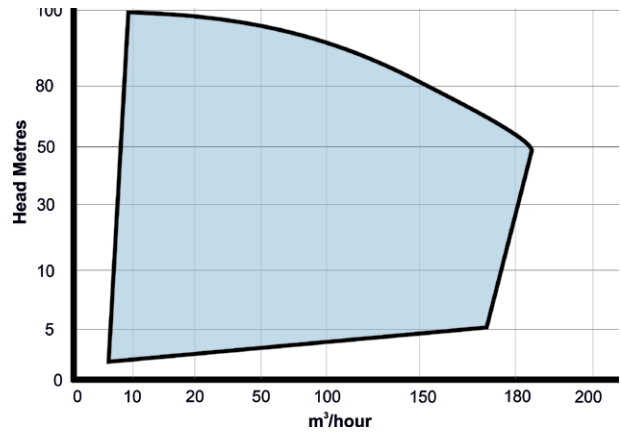

- Single, double and flushed seals.
- Tri-Clamp connections.
- Quick release pump body to ease cleaning.
- SS motor shroud available.
- Easy-cleaning, open type impeller delivers smooth pumping performance and the passage of solids.
- Enlarged inlets available for larger suction lines.
- Standard CIP capability.



## APV SPARE PARTS

AxFlow have invested over £ 1,000,000 in APV spare parts and products.

- Pumps  
DW seals, O rings impellers.  
W+ seals, O rings impellers, complete pumps
- Valves  
Seal kits, actuators, O rings, springs, flaps, gaskets flanges and complete SV1 valves.

Heat Exchangers  
Plates, and plate gaskets.

Homogenisers  
Guiding rings, bearings, plungers, pistons, valves, valve seats, impact rings, seals and packings.

# 2-3 days

Standard lead time for stocked parts and products

email: [apv@axflow.co.uk](mailto:apv@axflow.co.uk)





## Centrifugal

### W+

The W+ Series is a modular, high specification hygienic product range with a variety of alternative construction types based around the patented SPX spiral shaped rear flange which results in reduce turbulence leading to gentle product handling and increased efficiency.

- St Steel
- EPDM
- Viton
- PTFE

- ✓ Solids
- ✓ CIP
- ✓ Self Priming
- ✓ Corrosive Liquids
- ✓ Abrasive Liquids

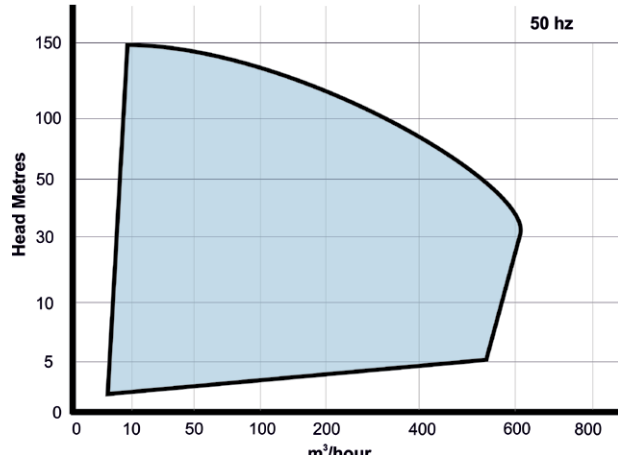

- Direct visual inspection possible.
- Fully CIP compatible.
- Tri-Clamp, I-Line, Bevel Seat connections.
- Flow directed to seal to assure sanitation.
- Seal spring external to liquid product.
- Constructed for easy maintenance.
- Designed to offer minimal turbulence and vibration.
- Inter-changeable single, balanced and flushed seals.



- UCi** with integral inducer
- 50 to 70% reduced NPSH requirement.
  - Operates with fluids close to boiling.
  - Extends the operational viscosity range of the pump to 500 cP.
  - Can handle gas laden liquids.



- UCh** high pressure construction
- For system pressures up to 60 bar.
  - Higher external torsional loads.



- UC** Multi-stage
- Can deliver differential heads up to 150m.
  - CIP friendly.
  - Long coupled for easy maintenance.



- UCs** self priming construction using a unique eccentric air screw design.
- Reduced noise levels.
  - 3A and EHEDG compliant.
  - Can withstand particulates.



- UCa** aseptic construction
- Seals can be sterile flushed.
  - Hygienic fittings as standard.
  - Can be used with barrier media.



## Centrifugal

### AquaRange

The AquaRange of mono block pumps is made up of :

- **AquaFit** close coupled horizontal single stage end-suction pumps with performances and key dimensions in accordance with DIN 24255.
- **AquaLine** in-line vertical close coupled pumps available as either a single or double construction.

Cast Iron  
Bronze  
St Steel

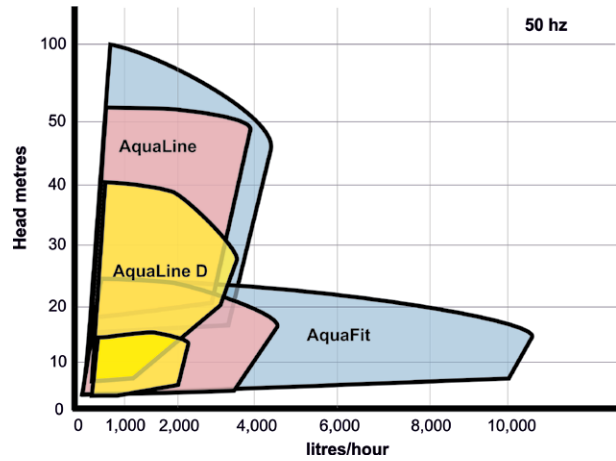
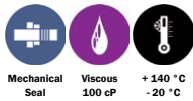

- All pumps comply with the ErP Directive.
- Dynamically balance impellers.
- Low NPSH requirements.
- High quality castings.
- Compact construction.
- Designed and manufactured to ISO 9001.
- Short delivery times.
- A choice of connection types.

### NA and NE

DIN24255-EN733-UNI 7467 long pumps. The NA range being the standard construction which is complimented by the more robust and ATEX certified NE range. Many of the NA range models are stocked.

Cast Iron  
Bronze  
St Steel

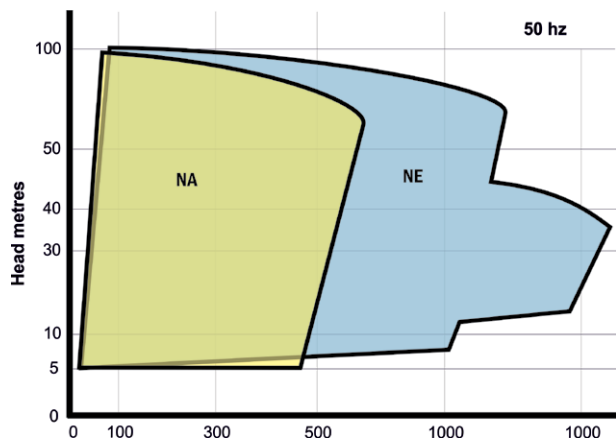
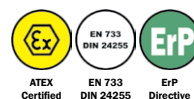

- Oversized shaft with oil lubricated ball bearings.
- Dynamically balanced impellers.
- Many sizes ex-stock.
- High efficiency & low NPSHr.
- CI with optional SS and Bronze impellers.
- Available with a range of seals.



## Centrifugal

### TK-TKR

A comprehensive range of horizontal and vertical multistage boiler feed pumps designed to ISO 9908 and ISO 9906 deg 2. All models can conform to the latest ErP directive requirements.

St Steel  
Carb Steel

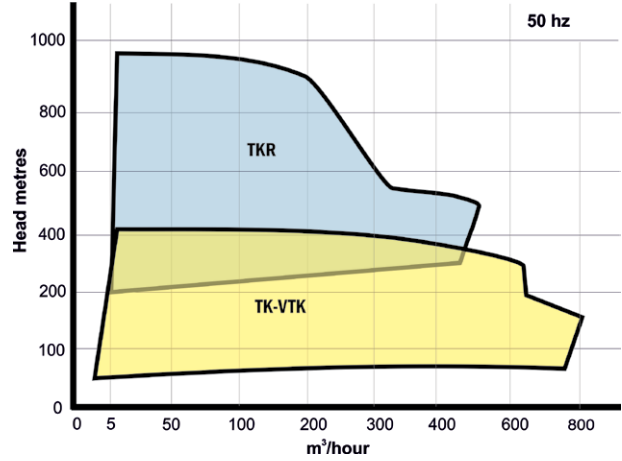

- Oversized shaft.
- Double, oil lubricated ball bearings.
- Dynamically balanced impellers.
- High efficiency & low NPSHr.
- CI with optional SS and Bronze impellers.
- Available with a range of seals.

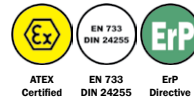
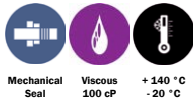

### PD Range

Robust split case, double suction pumps available in either horizontal or vertical configurations. The position of inlet and outlet nozzles (in the lower half case of PD horizontal pumps or in the rear half case of PDV vertical pumps) allows inspection and repair without removing the pump from it's position.

Cast Iron  
Bronze  
St Steel

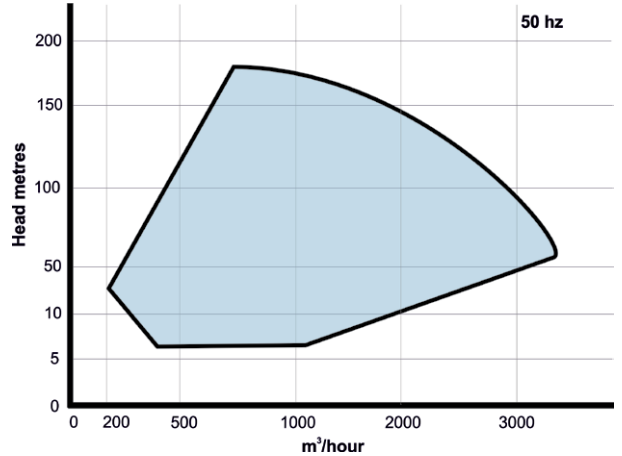
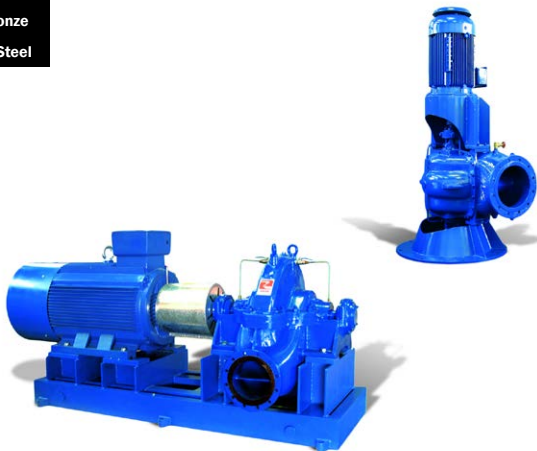

- Replaceable shaft sleeves.
- Pump body in CI optional steel or ductile iron.
- Impellers CI optional DI and SS.
- Grease or oil lubricated roller bearings.
- Gland packing or a range of mechanical seals.

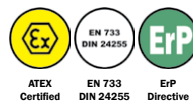
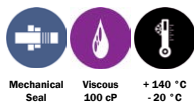



## Centrifugal

### Warman Vortex Pumps

Industry's toughest grit-handling vortex pump range based around the Wemco recessed vortex impeller. Warman pumps are designed allow free solids passage of up to 250mm particle size. They can handle animal parts and even feathers. To aid with abrasive applications they can be manufactured with Wemco's hi-chrome wear resistant metal.

Cast Iron  
St Steel  
Hi-Chrome



- Solids
- Self Priming
- Corrosive Liquids
- Abrasive Liquids

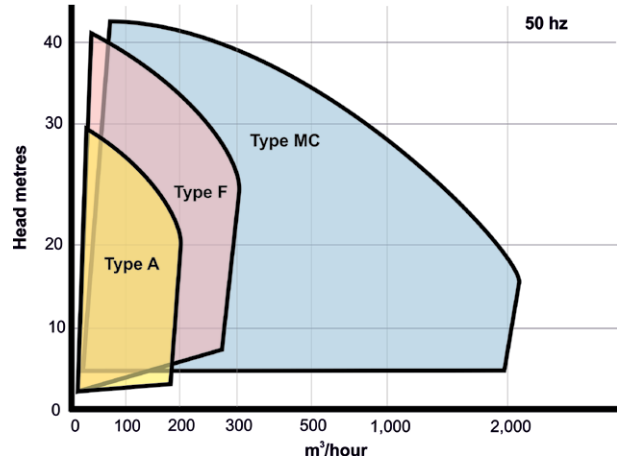

- Recessed vortex impeller.
- Generous wear allowances.
- Resistant to grit abrasion.
- Casing and volute thickness over 15 mm
- WP vertical cantilever range has no bottom bearing and will run dry.
- Gland packing or mechanical seals.
- Up to 250 mm free solids passage.

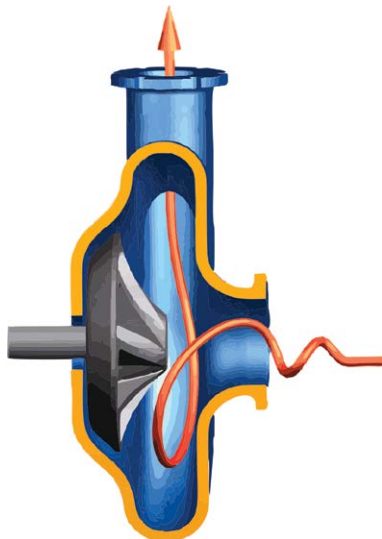

### The Warman Vortex Principle

The impeller develops a swirling vortex, which extends into the suction pipe, drawing solid particles into the liquid stream.

Particles are drawn into the pump, most of them will be discharged within one revolution due to the centrifugal force induced by the vortex action.

A range of different vortex impeller types can be fitted to ensure the most effective and efficient pump is installed.





**Centrifugal**

**Hidrostal Screw Centrifugal Pumps**

Hidrostal pumps are built around the unique hydraulic action of a Hidrostal impeller that delivers a long slow turn from the axial to the radial direction. This coupled with a large free passage provides a unique combination of hydraulic characteristics with a good hydraulic efficiency.

- Cast Iron
- Duct Iron
- St Steel
- Duplex



- ✓ Solids
- ✓ Low Shear
- ✓ Corrosive Liquids
- ✓ Abrasive Liquids

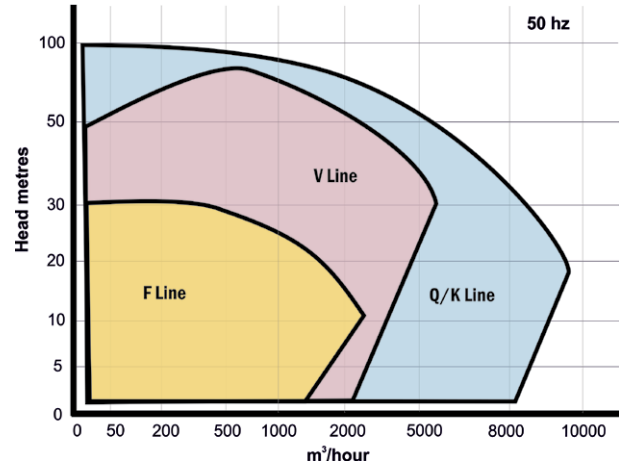

- Mechanical Seal
- 10 bar
- Viscous 4,000 cP
- +150 °C -5 °C



- Gentle pumping action.
- Solids up to 300 mm diameter.
- Low NPSH requirement.
- Steep pump curves that make pump flow less susceptible to fluctuations in pipe friction.
- High efficiencies.

Impeller type	Application	Example
Open Q- & K-line    	Conveying granulates	Suspended cereal, crystals, flakes
	Coarse, suspended solids	Solids-containing media, unscreened wastewater and slaughterhouse waste
	Fibrous materials with a tendency to become entangled	Suspended textiles and synthetic fibres such as nylon and wet wipes
	Solids with abrasive character	Surface water containing dirt and sand
Sealed V-line  	Viscous, muddy and gaseous liquids	Paint, glue, paper pulp, sludge from sedimentation, as well as gas-generating or flake-forming biological processes
	Highly abrasive media	Liquids with large quantities of sand or chippings as well as grinding and macerated waste
Sealed F-line  	Gentle conveying of voluminous materials	Sensitive materials such as fruit, vegetables and live fish



## Centrifugal

### SDM

Compact and robust centrifugal transfer pumps made from 316 stainless steel designed to handle a wide range of acids, solvents, alkalis and refrigerants. Fitted with Samarium Cobalt magnets SDM pumps can be configured to handle liquids up to 200°C.

- St Steel
- PTFE
- Carbon
- EPDM
- Viton
- FEP

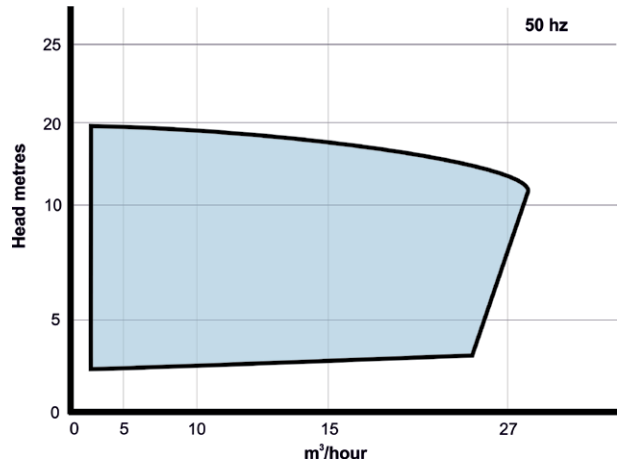

- No mechanical seals to leak or service.
- BSP, NPT, PN or ANSI connections.
- Can be mounted vertically.
- Vacuum welded internal magnets available.
- Can be constructed to suit off shore applications.

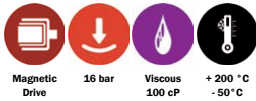

### STM

High specification regenerative turbine pumps for high heads/ low flow applications. Because STM pumps are machined from solid metal they offer an extremely wide range of design options and construction materials.

- St Steel
- Hastelloy
- Dup St St
- Titanium
- PTFE
- Carbon
- EPDM
- Viton
- FEP

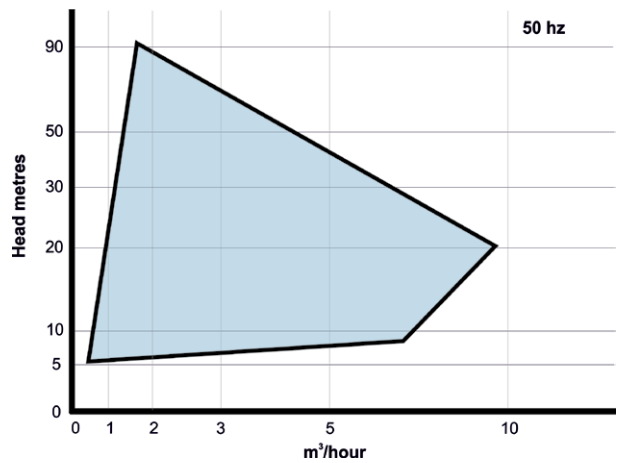

- No mechanical seals to leak or service.
- High system pressure capability up to 200 bar.
- Will pump up to 20% entrained gasses.
- Can be vertically mounted.
- Polished internal surfaces available.
- Threaded, Tri-Clamp, PN or ANSI flanges.





## Metering

### OBL

OBL manufacture both plunger and diaphragm type metering pumps. The range offers solutions for small dosing up to flows of 3.5 m<sup>3</sup>/hr. Using both plastic or metallic wetted parts OBL pumps can be used with a wide range of liquids.

St Steel
Hastelloy
PP
PVC
PVDF
PTFE

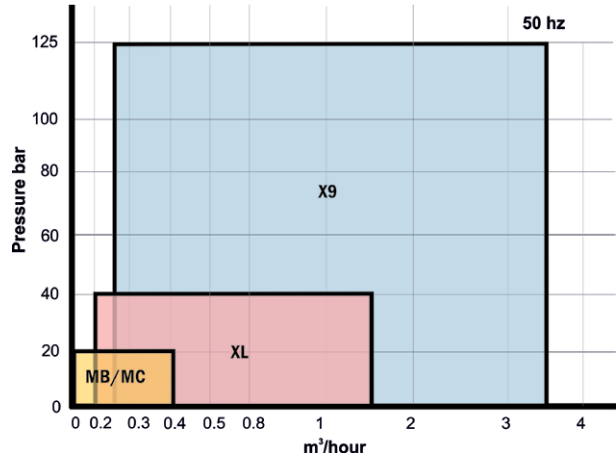

- OBL's unique (patented) mechanical diaphragm design ensures linearity between flow rate and percentage of stroke.
- A wide range of control mechanisms are available.
- Multiple pump arrangement is possible for most models.



### Pulsafeeder

Two ranges of hydraulically actuated diaphragm metering pumps with balanced single piece diaphragms. Hydraulic diagnostics provide immediate visual information about the pumps and their gearboxes are manufactured with high-quality materials, guaranteed for five years.

St Steel
Hastelloy
Dup St St
Titanium
Monel
PTFE
PVC
PVDF

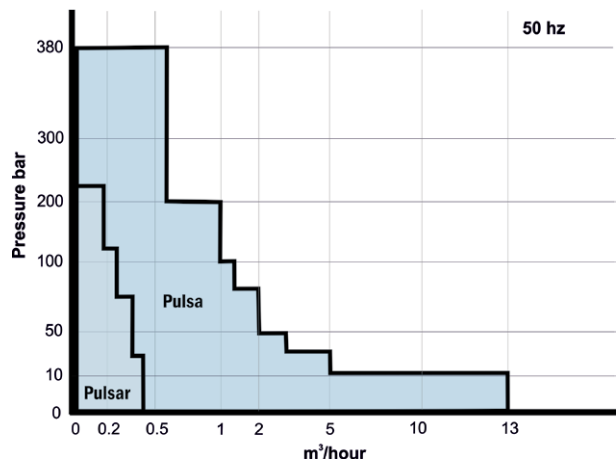

- Diagnostics give hydraulic operation, system over-pressure, diaphragm integrity and proper hydraulic oil fill level data.
- Three component check valves.
- Manual stroke length controls.
- Robust four bolt tie bar design provides.
- External hydraulic bypass.





## Heat Exchangers

### Gasketed Plate Heat Exchangers

Having invented the plate heat exchanger, APV gasketed heat exchangers remain amongst the best designed and constructed heat exchangers in the world.

- A hanging system that eliminates plate flexing.
- A unique clamping system incorporated within the plate profile.
- Adhesive free gasket retention system.

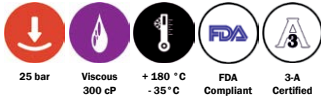

### EnergySaver

For processing low-viscosity media. Designed for high thermal efficiency with a very close temperature approach.



### DuraFlow

For medium or high viscosity media. Designed for continuous process and long run time.



### EasyFlow

For media containing fibres or pulp, requiring highest possible recovery without blocking.

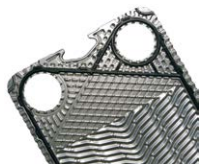

### DuoSafety

The DuoSafety system is an adhesive free early warning system, designed to detect leakages at an early stage and enable the end user to take precautions against intermixing of the fluids.

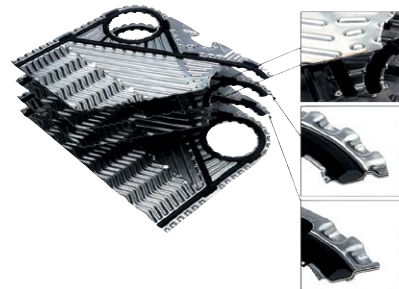

### ParaBrazed

A comprehensive range of compact brazed plate heat exchangers without gaskets. ParaBrazed units are especially suited for water heater, district heating units, gas boilers, and solar heating.

- No gaskets..
- Higher pressure rating.
- Higher temperatures.
- Higher viscosities.
- Stocked for short lead times.







## Heat Exchangers

### Tube in Tube Exchangers

APV ParaTube heat exchangers can be supplied with either straight tubes or corrugated tubes.

They are available in the four configurations and can be manufactured as a fully-welded design, with removable end caps or with built-in thermal expansion protection of O-rings or packing between the shell and tube bundle.

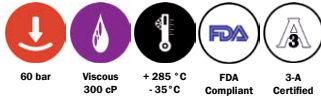

The **Corrugated Double Tube (CDT)** consists of a single corrugated tube positioned in a larger diameter outer tube. This design is particularly well suited for products with very high pulp or fibre content, or products which contain a substantial quantity of particulates which must be processed with a minimum loss of identity.

The **Corrugated Triple Tube (CTT)** consists of an inner tube positioned within a middle tube which is located in the outer tube. The result is an annular space where heat transfer effectively occurs from both sides. The triple tube is generally applied to high viscosity or Newtonian fluids.

The **Corrugated Quadruple Tube (CQT)** offers significant flexibility in the annulus gap to optimize heat transfer and pressure drop. This feature is critical to heat transfer of laminar and/or non-Newtonian fluids, particularly to product-to-product regeneration.

The **Corrugated Multi Tube (CMT)** consists of small diameter corrugated tubes aligned within a larger diameter outer shell. This maximizes heat transfer in a given volumetric space. The CMT is ideal for heating or cooling duties of lower viscosity products or those containing whole juice cells or pulp.

### Scraped Surface Heaters

Waukesha Scraped Surface Heat exchangers continue to replace many slow, inefficient batching operations with more uniform, controllable, and repeatable processing. Their superior heat transfer performance and ability to handle a wide range of viscosities makes them the clear choice over tubular or massive plate heat exchangers in viscous applications.

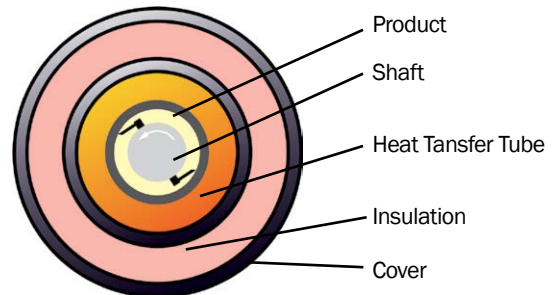

They work on a simple concept; by heating or cooling continuously moving product by providing a large heat transfer surface for a small amount of product in a confined space.

- Energy and cost efficient.
- Consistent.
- Good with viscous products and those prone to crystallise.
- Easy to maintain.
- Suitable for aseptic applications.
- The constant agitation results in more consistent heating or cooling and eliminates stagnant areas.
- Gear motor drive - no couplings, belts or sheaves.
- Can be mounted vertically or horizontally.

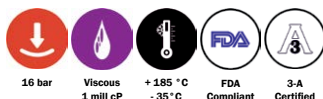



## Dispersion Pumps

### Homogenisers

APV is the world leader in the design, construction, and application of homogenisation. APV continue to be at the forefront of valve technology and offer the largest range of products.

The choice between the Rannie and Gaulin blocks ensures that you get the right machine for your specific application.

APV's liquid ends are dependable and low maintenance, offering precise operation while meeting all international sanitary specifications.

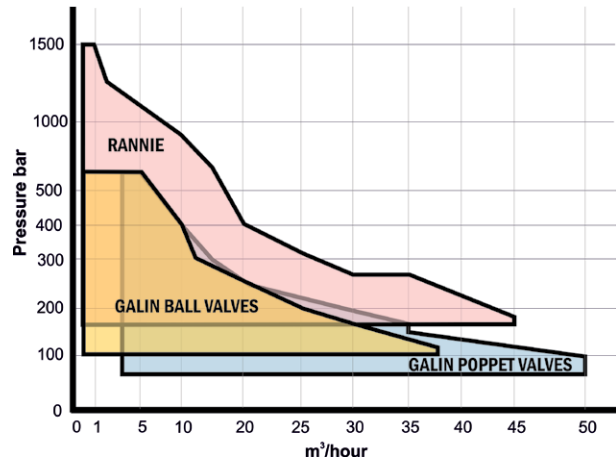

### APV - The largest Range

With a product history that goes back to 1892 APV have built up the largest range of of laboratory, pilot plant, production homogenisers, and colloid mills in the world.

### Galin Block

The Gaulin cylinder block provides an in-line flow pattern and minimises the number of sealed areas. Top and front caps improve accessibility and simplify maintenance. Poppet valves for low-viscosity, moderately abrasive products, Ball valves, designed for high-viscosity, abrasive products



### Rannie Block

The Rannie cylinder block allows for pressure segregation from the suction and discharge manifolds, reducing the possibility of breaking or cracking when adverse operating conditions are present or operating pressures exceed 600 bar.



### Micro Gap Valve

The SPX's patented Micro-Gap (MG) Valve was developed to provide optimal performance for milk processing. The MG requires less operating pressure to achieve desired particle size, delivering increased product stability and savings on energy and maintenance costs.



A wide range of options are available for most APV homogenisers:

- Single or two-stage designs.
- Hydraulic valve actuation or automatic hydraulic systems.
- Aseptic cylinders
- Electronic pressure transmitters.
- High-pressure outlet.
- Inlet pressure gauges
- Plunger lubrication control packages
- Tungsten carbide homogenising valves.
- Square plunger seals and ceramic plungers (Rannie only)
- Thermostat/oil temperature.
- Acid-proof cylinder (Gaulin only)
- Ceramic plungers with U- or V-rings.
- Explosion-proof design .
- Electro-polished wetted components.
- High-temperature design.
- Flow switch - power end cooling
- Oil filtration units.



## Valves

### Aseptic Valves

Aseptic valves for aseptic processing systems, for example cold aseptic filling systems in the food & beverage industries, product handling to UHT plants in the dairy industry applications.

- Single seat valves for shut-off, change-over, manifold or tank outlet applications.
- Diaphragm valves in either hand-operated or pneumatic actuated versions.



### Process Valves

The APV range of process valves has taken over 50 years to develop and as a result is extremely wide with numerous options and alternatives.

- Constant pressure valves.
- Ball valves.
- Sampling valves.
- Non-return valves.
- Safety valves.
- Pressure relief valves.



### Butterfly Valves

The APV DELTA butterfly valves are stop valves which can be actuated either manually or pneumatically. They are robust, reliable and designed to save space.

- Smooth product passage.
- Unique metallic stop prevents the valve flanges from being over tightened.
- One actuator covers all models.
- Sample.
- Designed for easy cleaning.



### Single Seat Valves

APV single seat valves are designed with handling, installation and maintenance in mind. The SWmini range takes the sizes down to DN 25.

- Thick walled to protect seat area.
- Wear resistant PTFE shaft seals.
- Ball shaped housing prevents sump or dome, making CIP more efficient.
- Metallic stop defines seat seal compression.



### Mixproof Valves

With a background in the food and beverage industry APV have a very wide range of mixproof valves.

- Single seals.
- Double seals
- CIP and SIP designs.
- Drinks specific designs.
- High pressure (100 bar) versions.



### Regulating Valves

APV offer two ranges of regulating valves the RG4 and RGE4 both designed for continuous hygienic flow control.

- Ball shaped housing.
- Marked profile seats.
- Crevice-free sealing.
- CIP and SIP.
- Seal incorporated in the valve seat.



### Control Units

a portfolio of control units that can be fitted to most APV valves to give greater control and process integration.

- 24V DC Direct Connect
- 110V AC Direct Connect
- 31 and 62 extended addressing)
- Options for Seat Lift Detection (SLD) on mix proof valves
- Can be integrated networks such as SinecL2/ET200, Interbus-S, Profibus, DeviceNet, CAN-Bus, Modbus, RS485, RS422, or RS232C.





## Mixers

### TPX

Static in-line mixer- Ideal for blending two low-viscosity liquids that offers a low-cost mixing alternative as no tank is required. Max capacity 10,000 l/h.



### DAR

In-line mixer- For blending a low-viscosity liquid into a high viscosity liquid such as butter blends which can be cleaned simultaneously with the pipeline. Max capacity 6,000 l/h.



### TPM

Batch mixer based on circulation via a buffer tank- For dispersion of highly soluble powders. Max capacity 50,000 l/h.



### Liquiverter

In-line/batch mixer for mixing of liquid/liquid, liquid/powder and liquid/particulates. Max capacity 3,000 litres.



### Instant

In-line/batch mixer for recombination, based on vacuum technology that handles high solid levels, high shear emulsification, vacuum mixing and de-aeration. Max capacity 10,000 litres.



### Flex-Mix Power

Aseptic in-line aeration mixer designed for liquid/liquid and liquid/gas dispersion. Capable of continuous mixing and emulsification. Capacity 5,100 kg/h.



### Flex-Mix Processor

Multi-flexible mixing and processing systems for formulated and complex products that offers both gentle agitation or high shear mixing for emulsification. They can carry out pasteurisation, vacuum mixing and particulate dispersion. Max capacity 3,000 litres



### Cavitator

The APV Cavitator can heat liquids in seconds by using the forces of cavitation in a controlled manner rather than typical impellers or blades. Because the heat is created inside the liquid the process minimises shear and eliminates both scaling of equipment and scorching of the product.





## Dispersion Pumps

### Shear Pump

The shear pump action produces mechanical, hydraulic, ultra-sonic and controlled cavitation for uniform in-line or batch processing with no aeration. The mixing action is equivalent up to a 500 psi homogenizer.

- Texturises products such as soft cheeses and pastes.
- Emulsifies oil and water based ingredients.
- Provides continuous, on-line blending
- Reconstitutes powdered products.
- Provides uniform dispersion.
- Polishes products to provide a smoother texture.

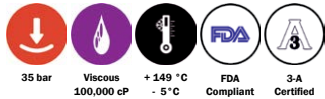

### Colloid Mill

Colloid Mills dispense product in-line through larger openings. A serrated conical stator and serrated rotating cone make up the emulsifying head. You get up to 50% more flow rate with less heat than other mills. With only 7 basic parts they quick and easy to clean. The mixing action is equivalent up to a 1,200 psi homogenizer.

- Can be adjusted while operating.
- 50% more flow rate with less heat than other mills.
- Calibrated ring sets spacing; no special tools.
- Suitable for CIP.
- Clearance setting does not effect product movement.
- With only 7 basic parts they quick and easy to clean.

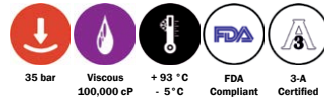

**> APV Repair and Maintenance**

AxFlow offer a range of on-site or off-site repair and maintenance services for all of the APV product range .

AxFlow boasts a nationwide network of pump repair facilities and an experienced strategic partner who handles the servicing of APV dispersion products, valves and heat exchangers that includes a 48 hr plate pack replacement service.

email: [apv@axflow.co.uk](mailto:apv@axflow.co.uk)



## Comprehensive Hygienic Facilities And Procedures

Our hygienic repair system was developed in partnership with a major UK food manufacturer and is based on five underlying principles:

1. Separating the hygienic and unhygienic parts as soon as possible.
2. Keeping them separate until the very last moment by using different equipment and areas (even within the main workshop).
3. Using the hygienic area as little as possible.
4. Recognizing that internal tolerances are critical to many processes.
5. Testing every pump we repair.

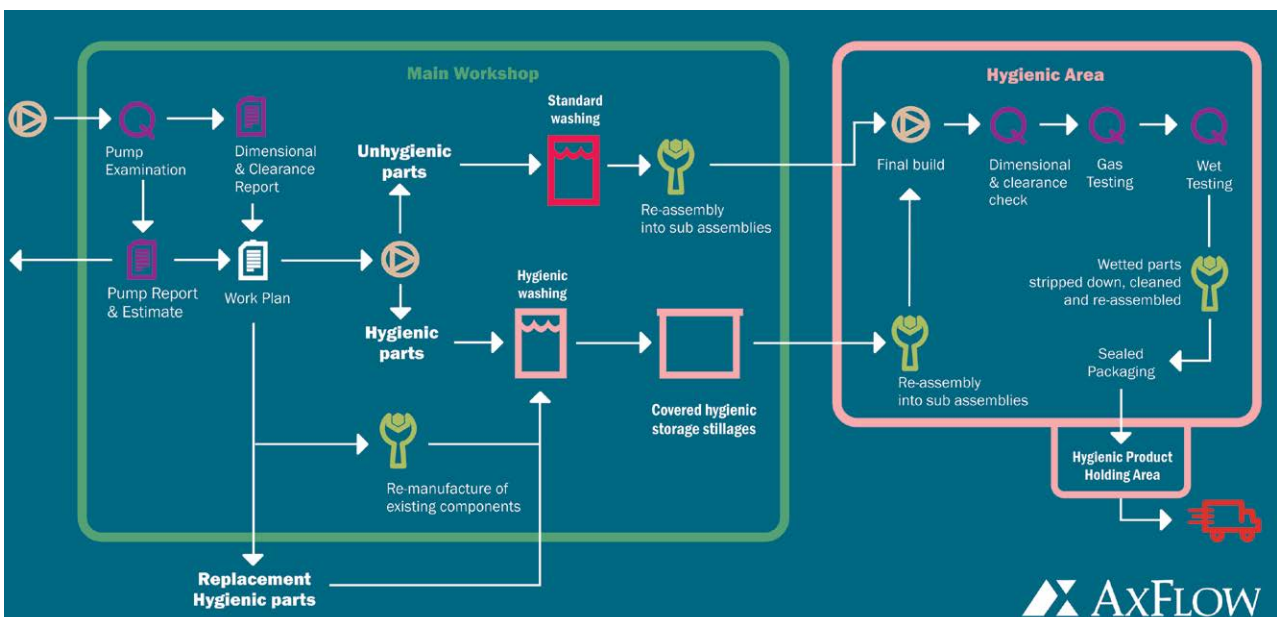
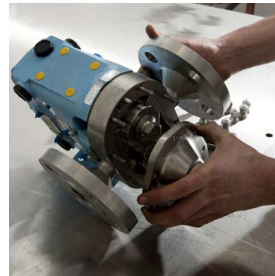
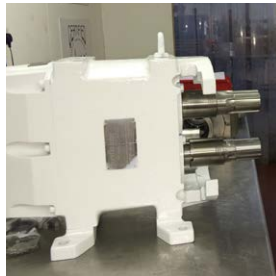
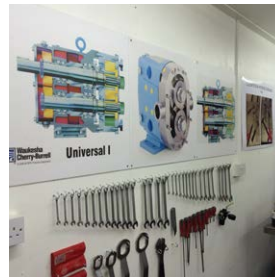



## We Know Positive Displacement Pumps

AxFlow are the acknowledged European leaders in the supply of positive displacement pumps.

This means that we truly understand positive displacement pumps and the special challenges that their repair can pose. It also means that we hold large stocks of components that reduce our repair times.

AxFlow represent many world leading brands and are happy to organise specific training courses for maintenance personnel.



	
	
	
	
	

### WHAT WE OFFER

- Original manufacturer parts
- Re-certification of ATEX models
- 12 months warranty on all repaired parts
- Air and water test on all repairs

## Extensive Maintenance Services For The Entire APV Range

AxFlow boasts a nationwide network of pump repair facilities and an experienced strategic partner who handles the servicing of APV dispersion products, valves and heat exchangers that includes a 48 hr plate pack replacement service.

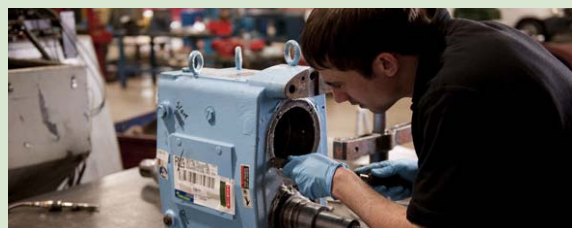

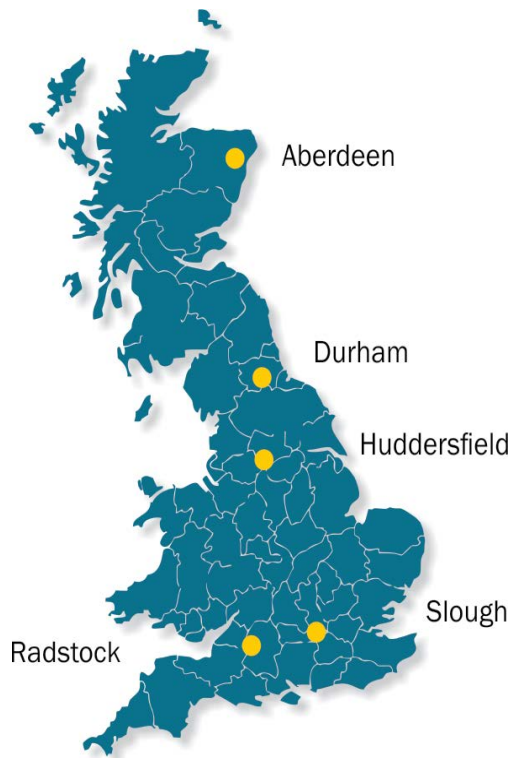

email: [info@axflow.co.uk](mailto:info@axflow.co.uk) [www.axflow.co.uk](http://www.axflow.co.uk)

### Slough (Head Office)

820 Yeovil Road, Slough Trading Estate  
Slough SL1 4JA  
Tel.: +44 (0)1753 255 600

### Radstock

14 Haydon Industrial Estate  
Radstock, BA3 3RD  
Tel. + 44 (0)1761 433285

### Huddersfield

Unit 9a, Fieldhouse Business Park, Old Fieldhouse Lane,  
Huddersfield, HD2 1FA  
Tel.: +44 (0)1484 543 649

### Scotland

Unit 3, Harlaw Centre, Howe Moss Crescent,  
Kirkhill Industrial Estate, Dyce, Aberdeen, AB21 OGN  
Tel.: +44 (0)1224 729 367

### Durham

Unit 16 Chilton Industrial Estate  
Avenue 3, Chilton, Ferryhill DL17 0QS  
Tel.: +44 (0)191 329 3189

---

*fluidity.nonstop*® is our promise and our commitment to offer service, product quality, performance and expertise the like of which has not been seen before. We are Europe's leading source of pumps and pump expertise for the process industry and we intend to maintain that position by working fluidly, and ceaselessly, to bring you the best.